

**SAMSUNG**

# GSM TELEPHONE

## SGH-X300

# **SERVICE** *Manual*

### GSM TELEPHONE



### CONTENTS

1. Specification
  2. Flow Chart of Troubleshooting
  3. Exploded Views and Parts List
  4. Main Electrical Parts List
  5. PCB Diagrams
  6. Block Diagrams
- \* **Disassembling Manual**
  - \* **Assembling Manual**

**SAMSUNG  
ELECTRONICS**



---

# 1. SGH-X300 Specification

---

## 1-1. GSM General Specification

	GSM900 Phase 1	EGSM 900 Phase 2	DCS1800 Phase 1	PCS1900
Freq. Band[MHz] Uplink/Downlink	890~915 935~960	880~915 925~960	1710~1785 1805~1880	1850~1910 1930~1990
ARFCN range	1~124	0~124 & 975~1023	512~885	512~810
Tx/Rx spacing	45MHz	45MHz	95MHz	80MHz
Mod. Bit rate/ Bit Period	270.833kbps 3.692us	270.833kbps 3.692us	270.833kbps 3.692us	270.833kbps 3.692us
Time Slot Period/Frame Period	576.9us 4.615ms	576.9us 4.615ms	576.9us 4.615ms	576.9us 4.615ms
Modulation	0.3GMSK	0.3GMSK	0.3GMSK	0.3GMSK
MS Power	33dBm~13dBm	33dBm~5dBm	30dBm~0dBm	30dBm~0dBm
Power Class	5pcl ~ 15pcl	5pcl ~ 19pcl	0pcl ~ 15pcl	0pcl ~ 15pcl
Sensitivity	-102dBm	-102dBm	-100dBm	-100dBm
TDMA Mux	8	8	8	8
Cell Radius	35Km	35Km	2Km	-

## 1-2. GSM Tx Power Class

<b>TX Power control level</b>	<b>GSM900</b>	<b>TX Power control level</b>	<b>DCS1800</b>	<b>TX Power control level</b>	<b>PCS1900</b>
5	33±2 dBm	0	30±3 dBm	0	30±3 dBm
6	31±2 dBm	1	28±3 dBm	1	28±3 dBm
7	29±2 dBm	2	26±3 dBm	2	26±3 dBm
8	27±2 dBm	3	24±3 dBm	3	24±3 dBm
9	25±2 dBm	4	22±3 dBm	4	22±3 dBm
10	23±2 dBm	5	20±3 dBm	5	20±3 dBm
11	21±2 dBm	6	18±3 dBm	6	18±3 dBm
12	19±2 dBm	7	16±3 dBm	7	16±3 dBm
13	17±2 dBm	8	14±3 dBm	8	14±3 dBm
14	15±2 dBm	9	12±4 dBm	9	12±4 dBm
15	13±2 dBm	10	10±4 dBm	10	10±4 dBm
16	11±3 dBm	11	8±4dBm	11	8±4dBm
17	9±3dBm	12	6±4 dBm	12	6±4 dBm
18	7±3 dBm	13	4±4 dBm	13	4±4 dBm
19	5±3 dBm	14	2±5 dBm	14	2±5 dBm
		15	0±5 dBm	15	0±5 dBm

## 2. SGH-X300 Flow Chart of Troubleshooting

### 2-1. Baseband

#### 2-1-1. Power ON

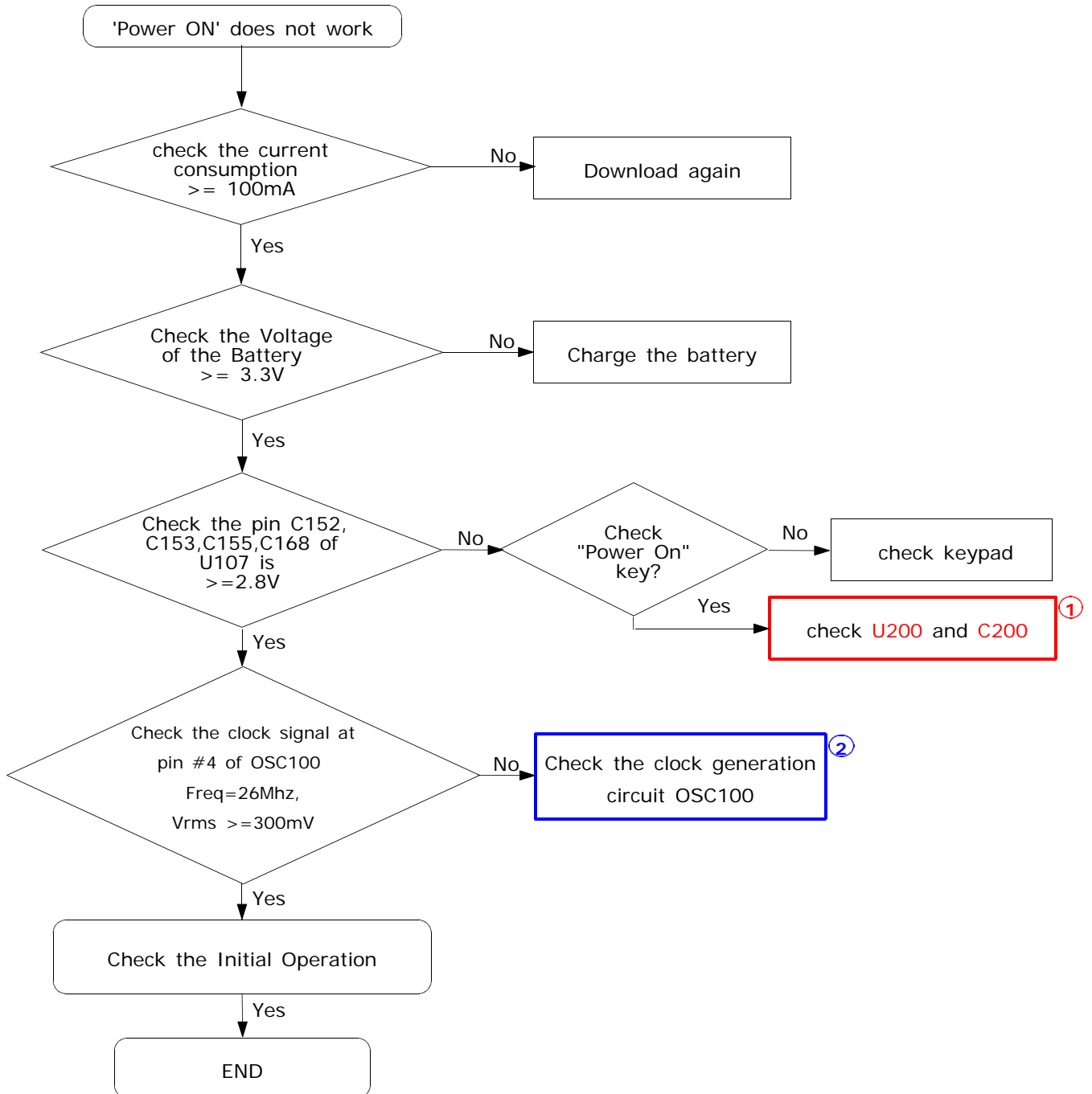

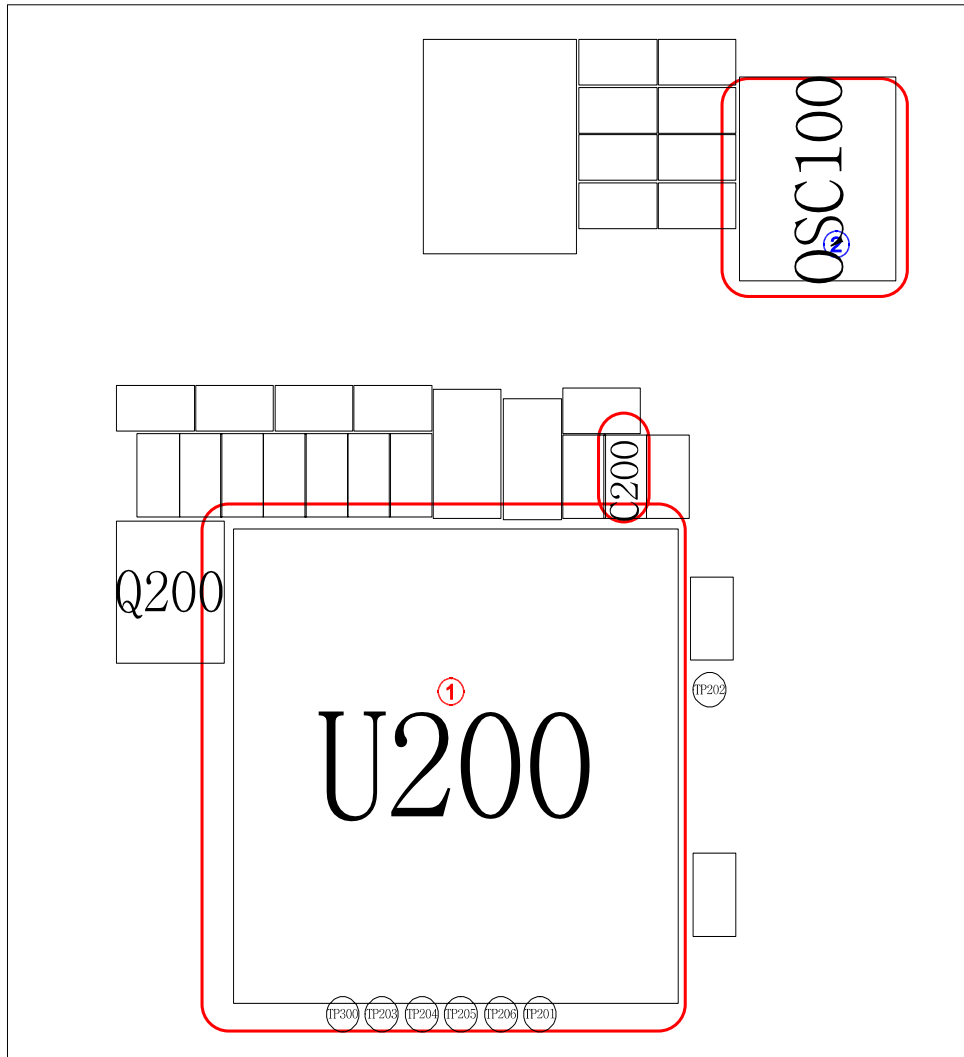
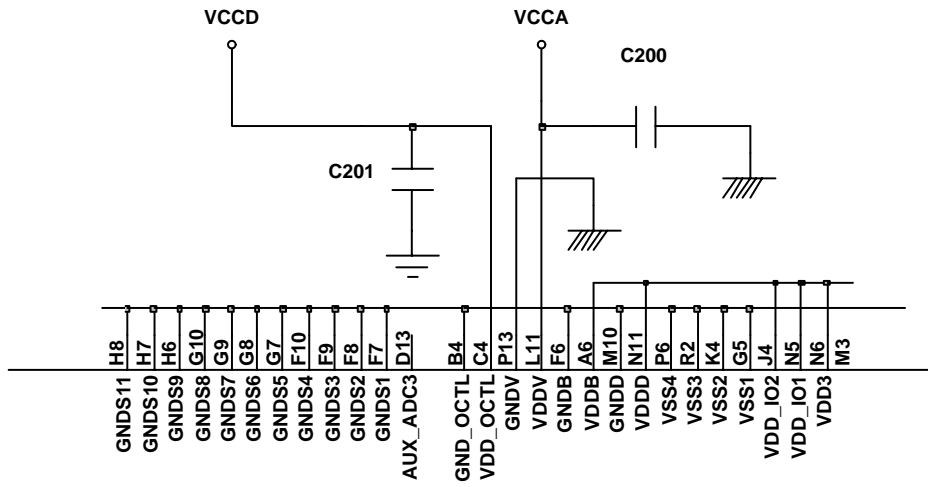

2-1-2. Initial

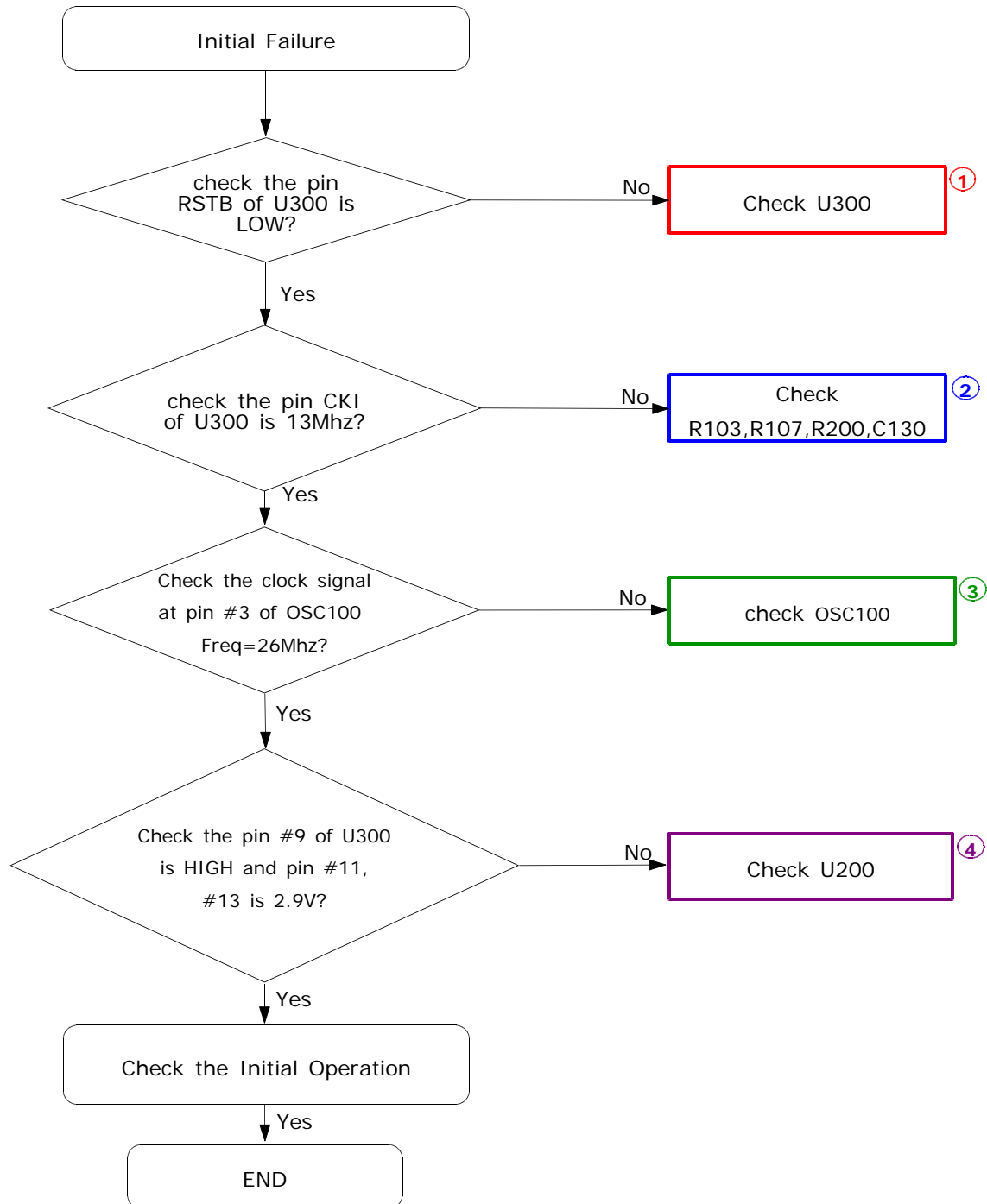

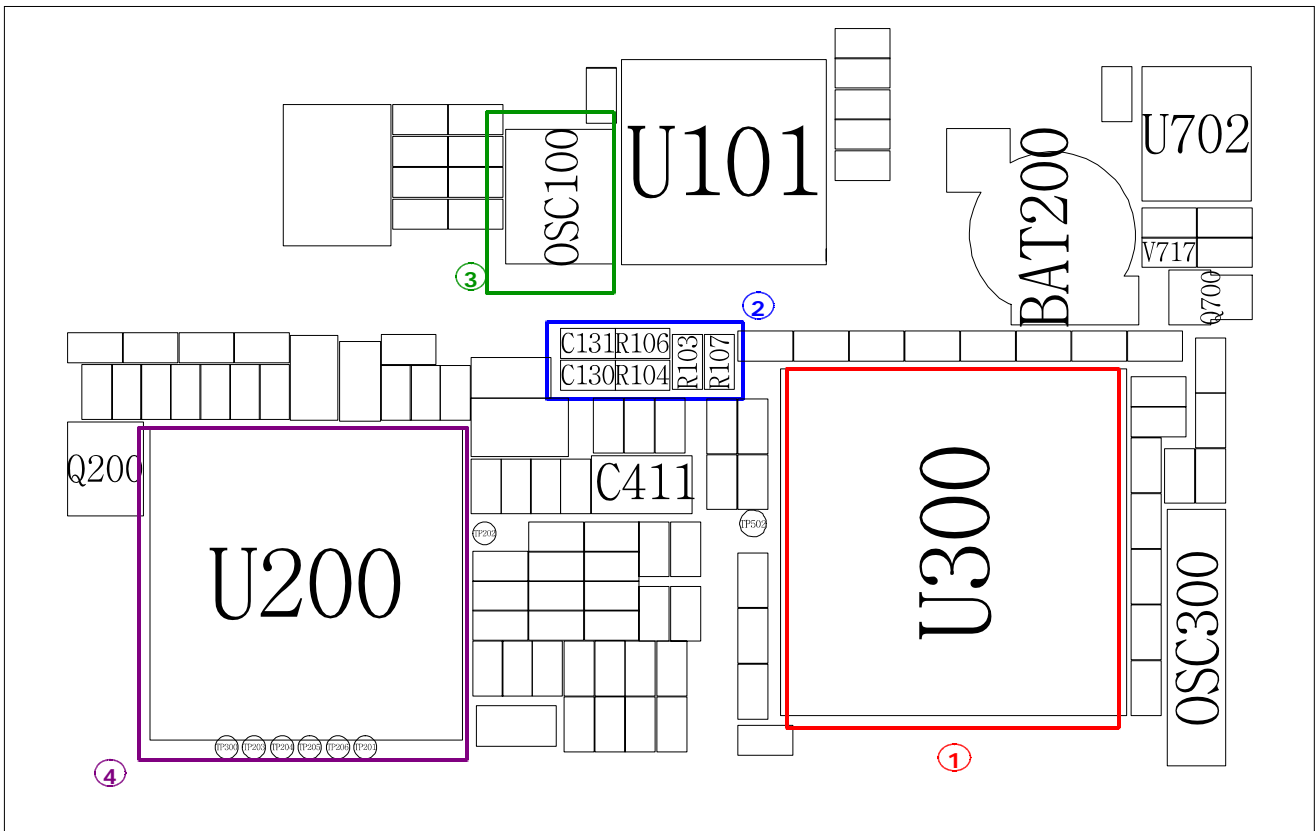
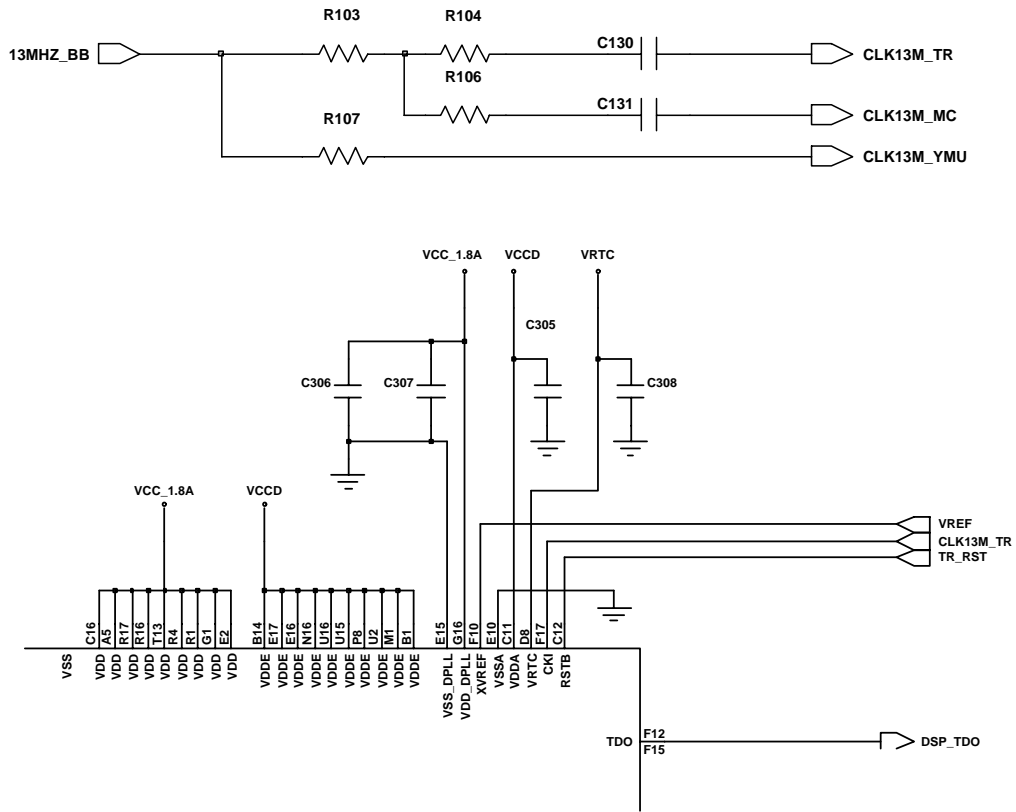

2-1-3. Sim Part

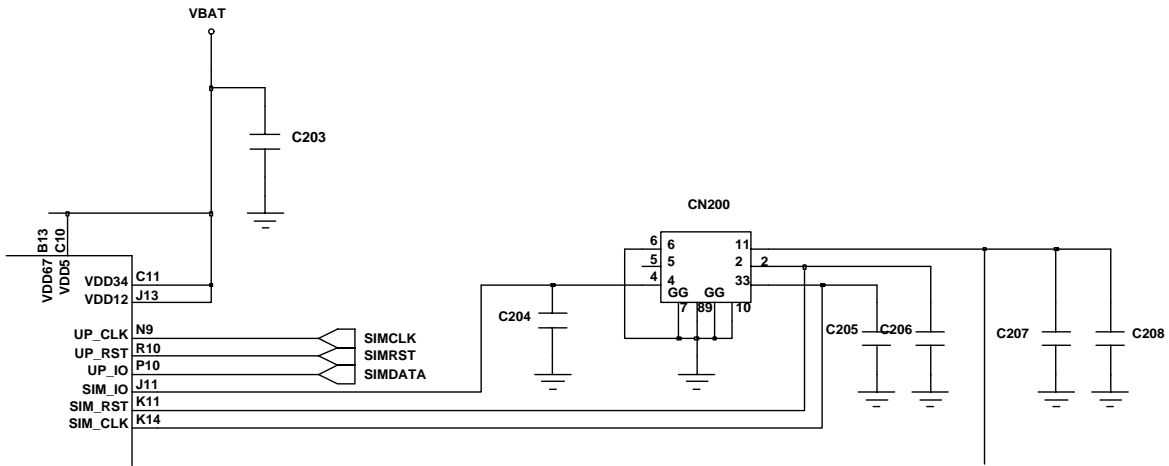
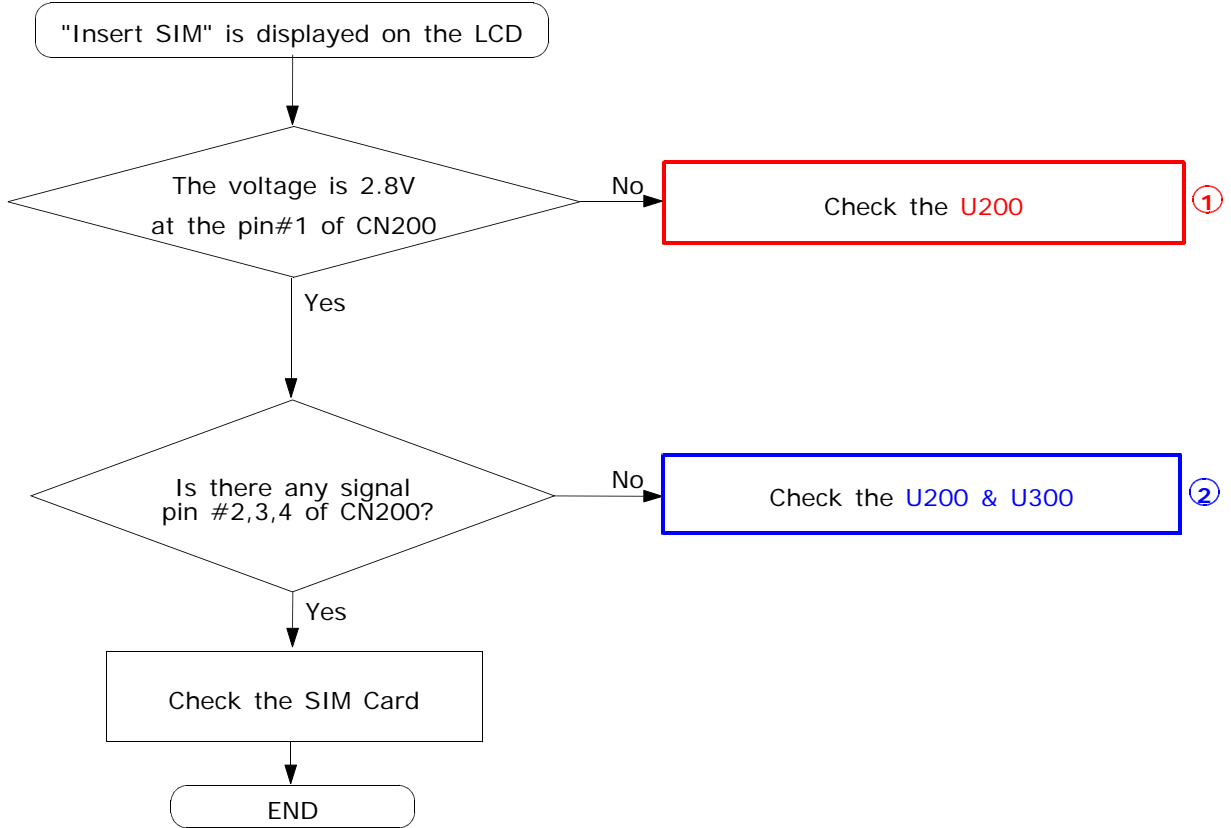

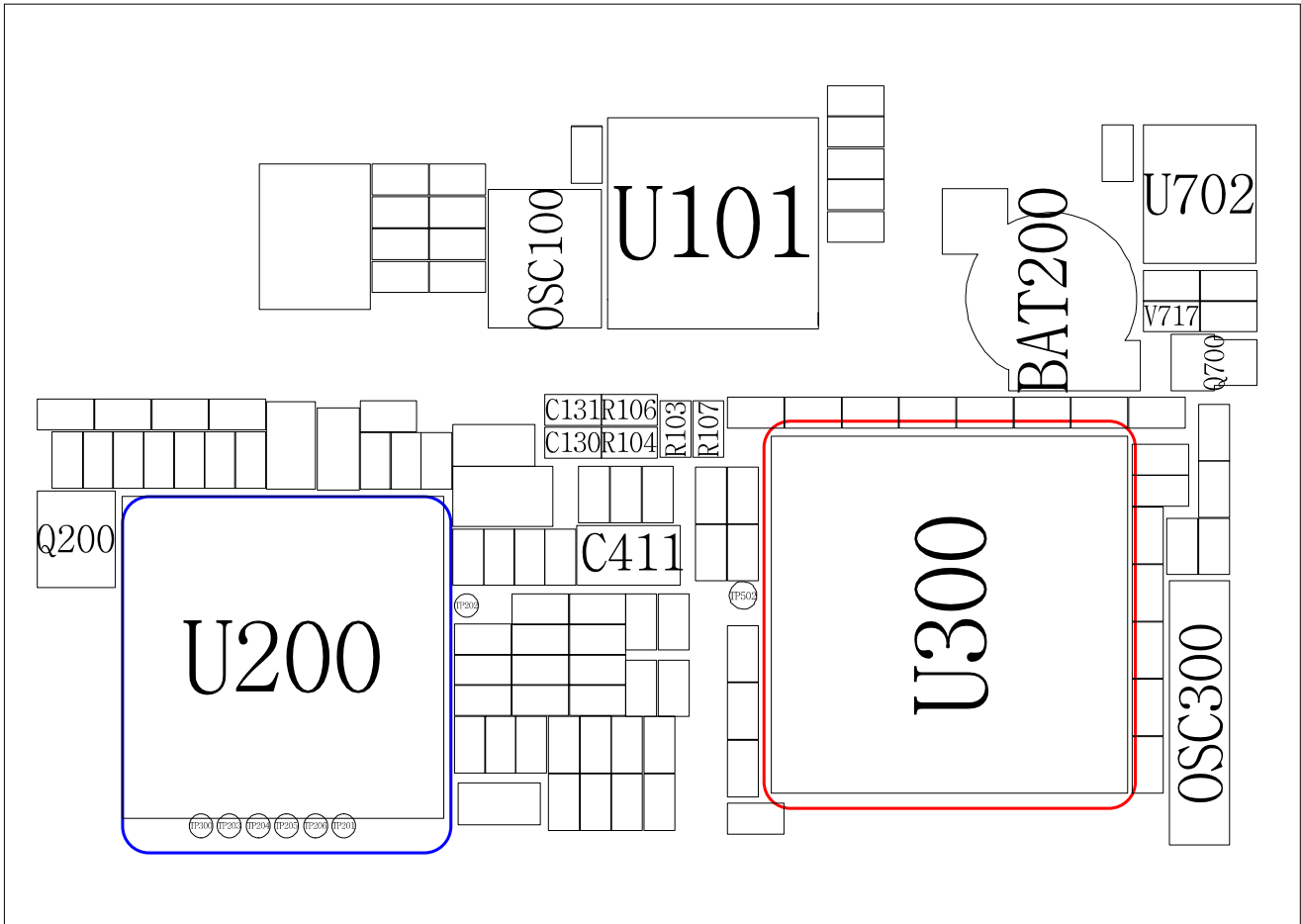

2-1-4. Microphone Part

\* Call with Sim before testing.

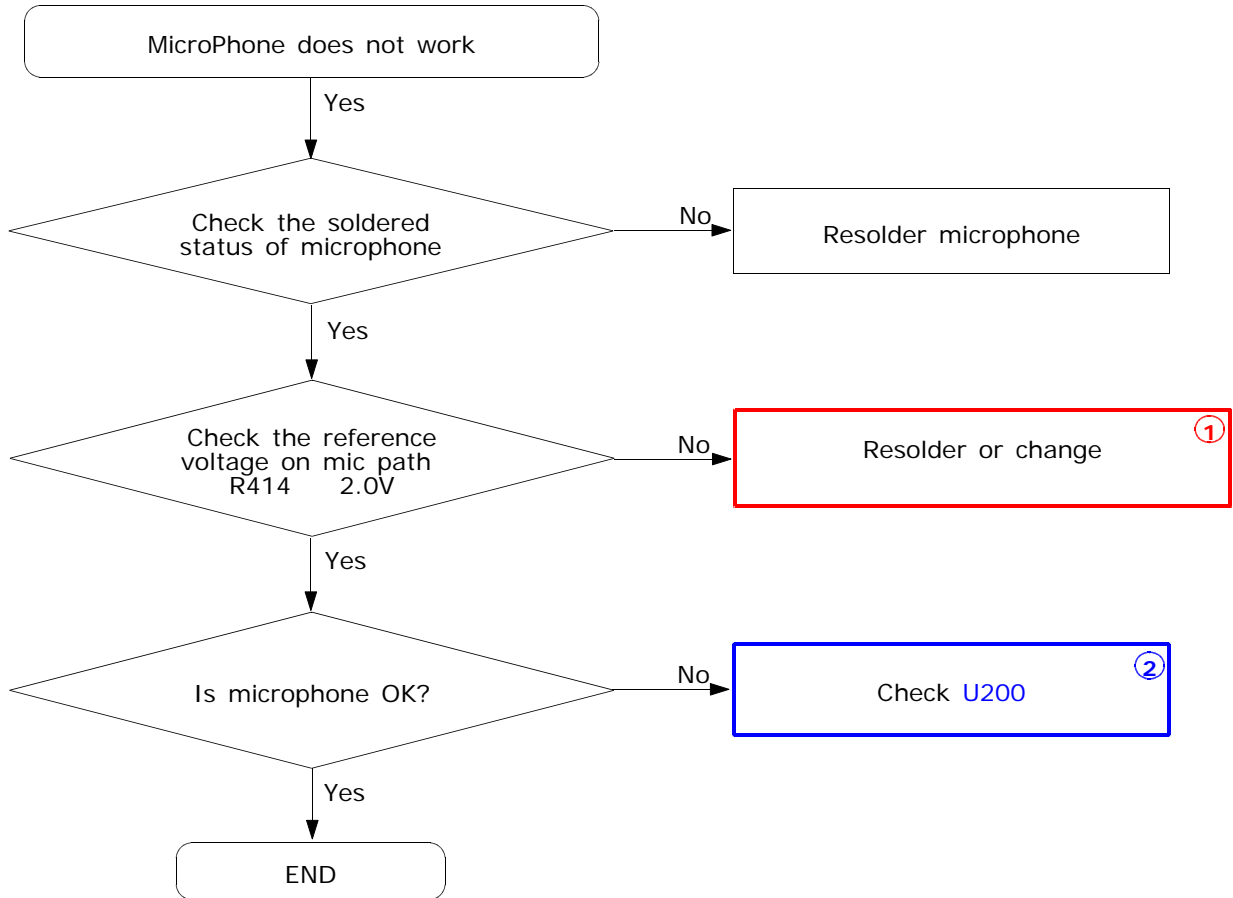

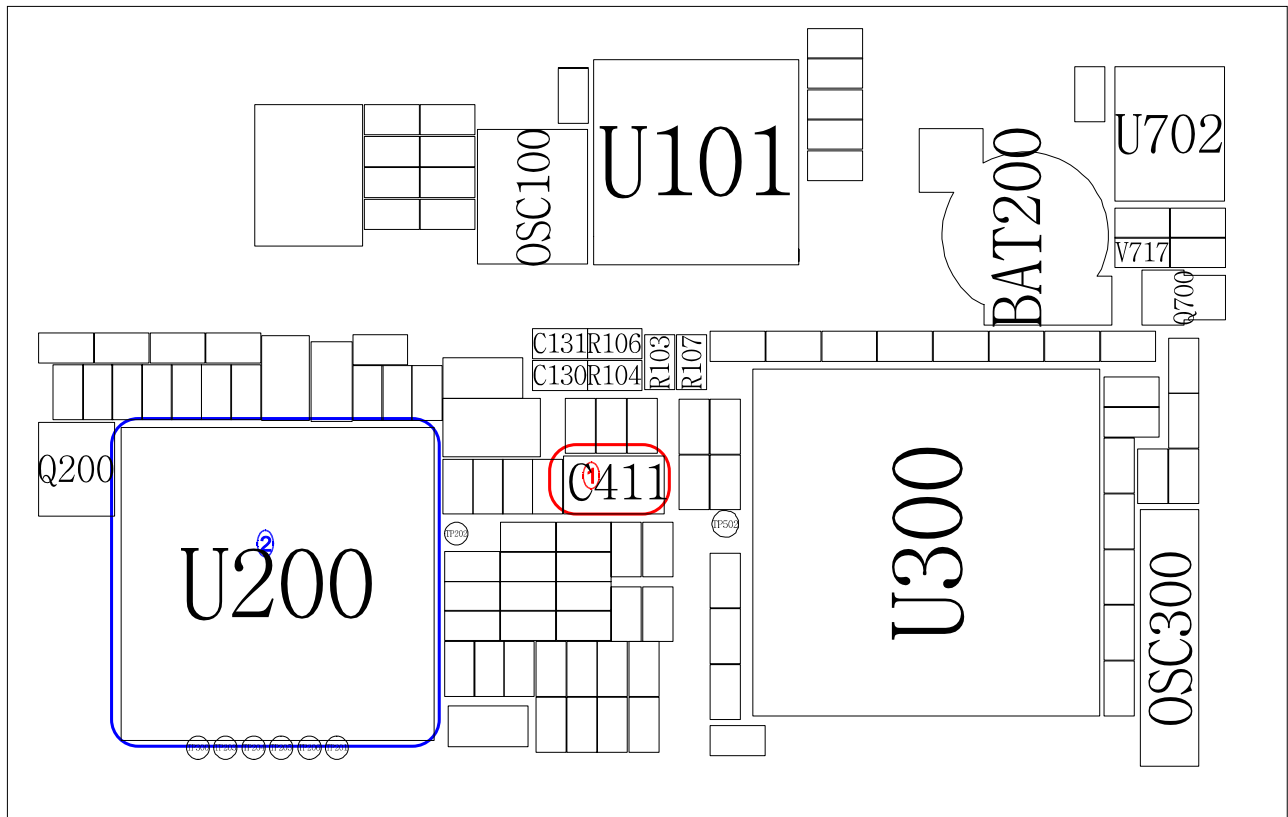
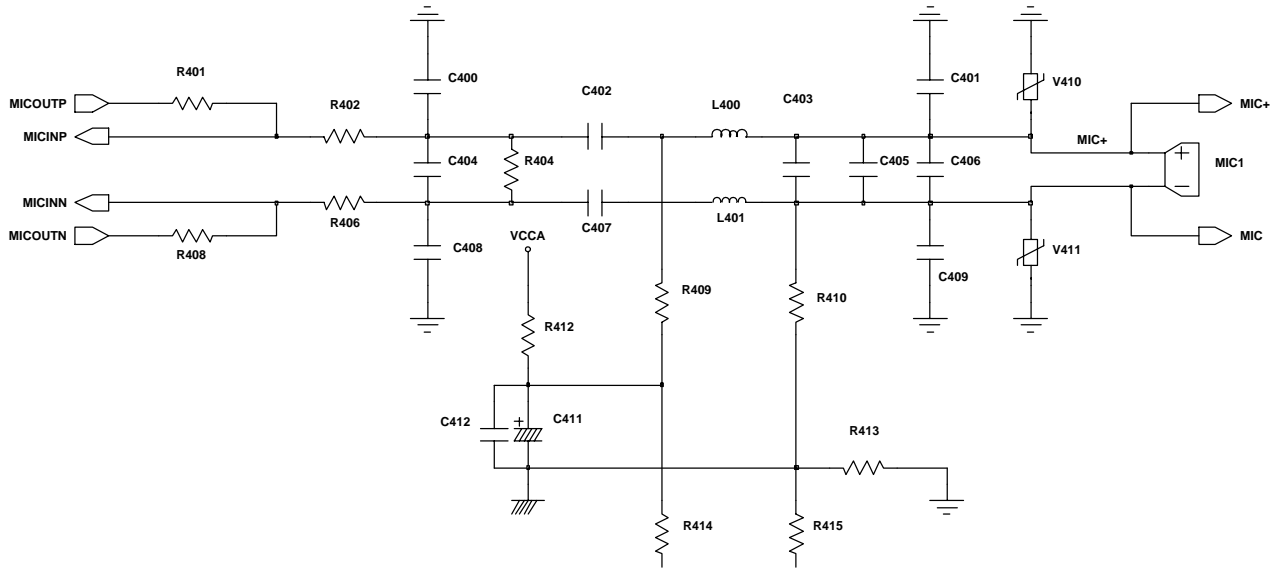

2-1-5. Speaker Part

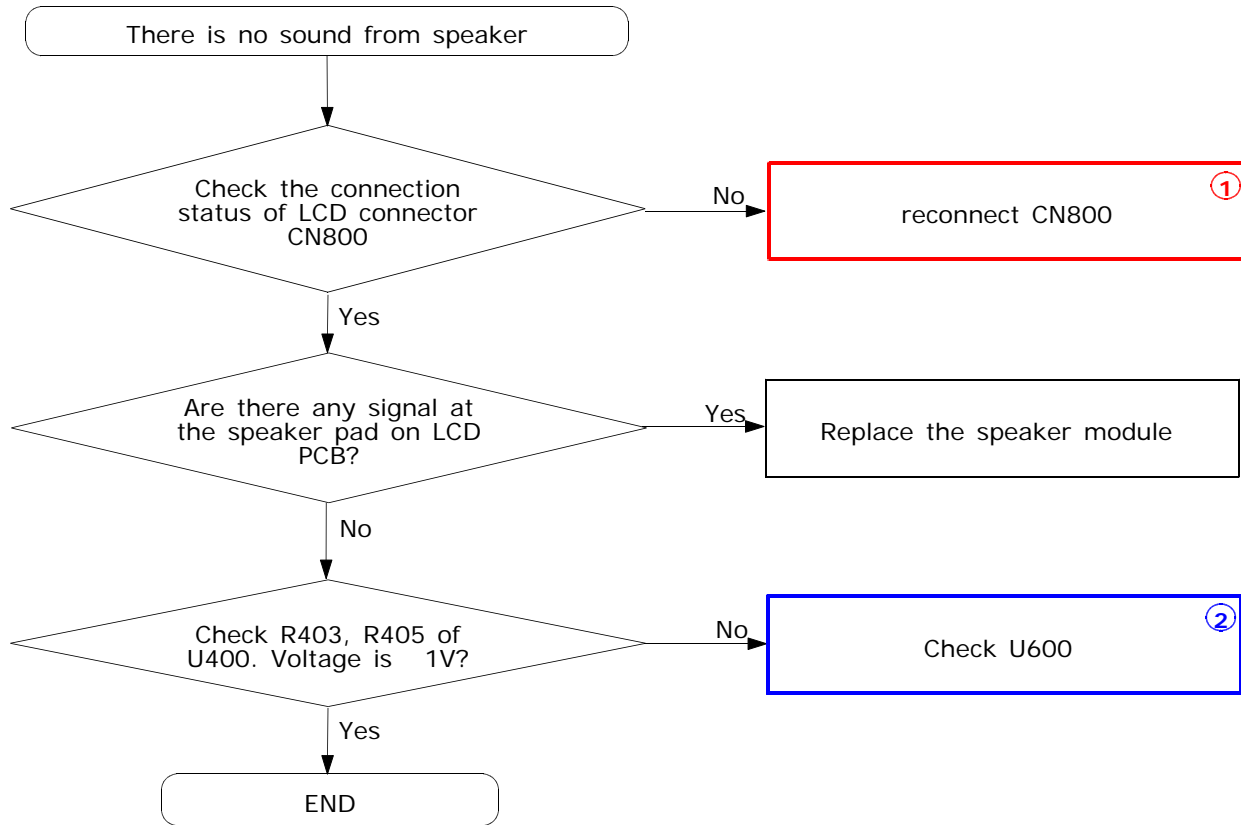

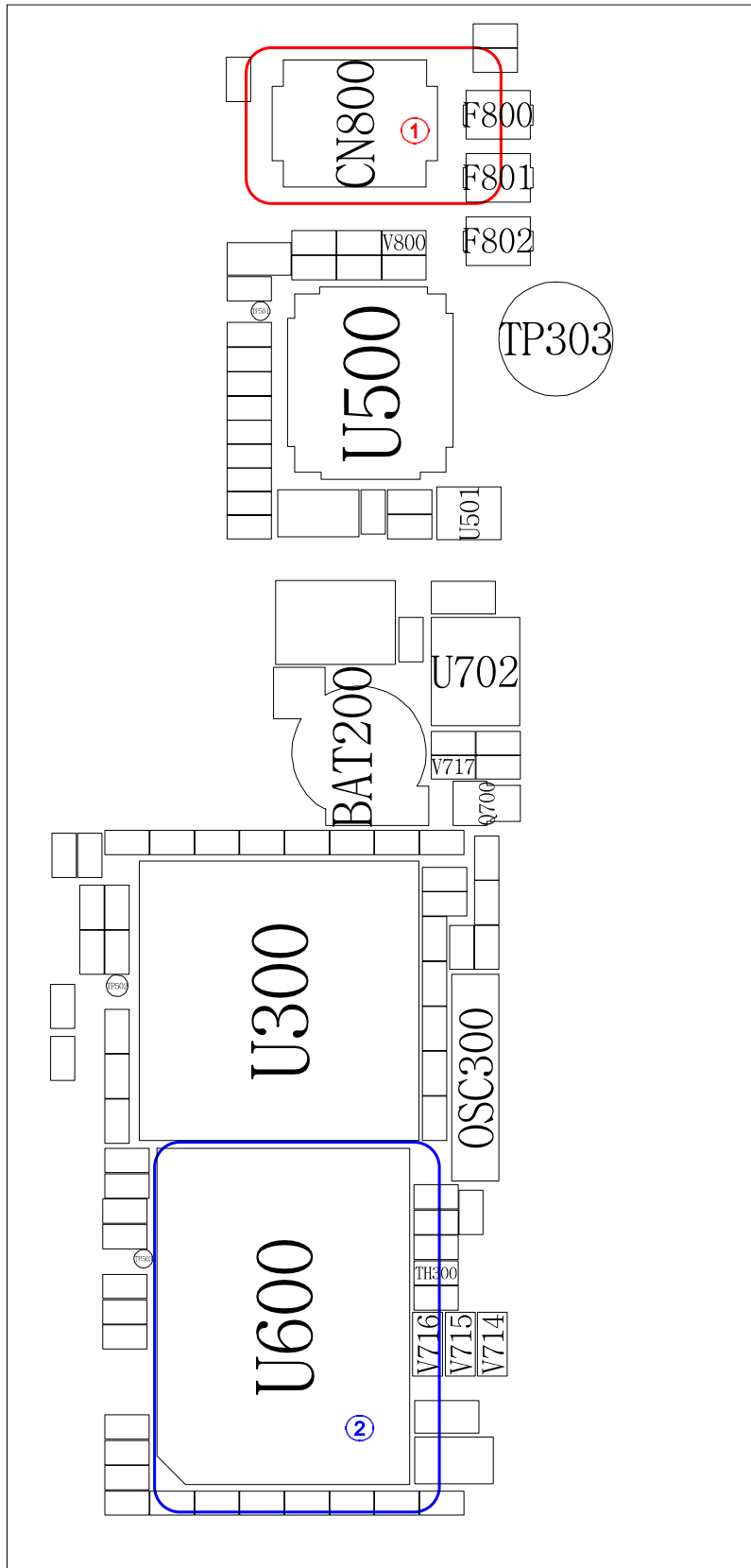

2-1-6. LCD backlight

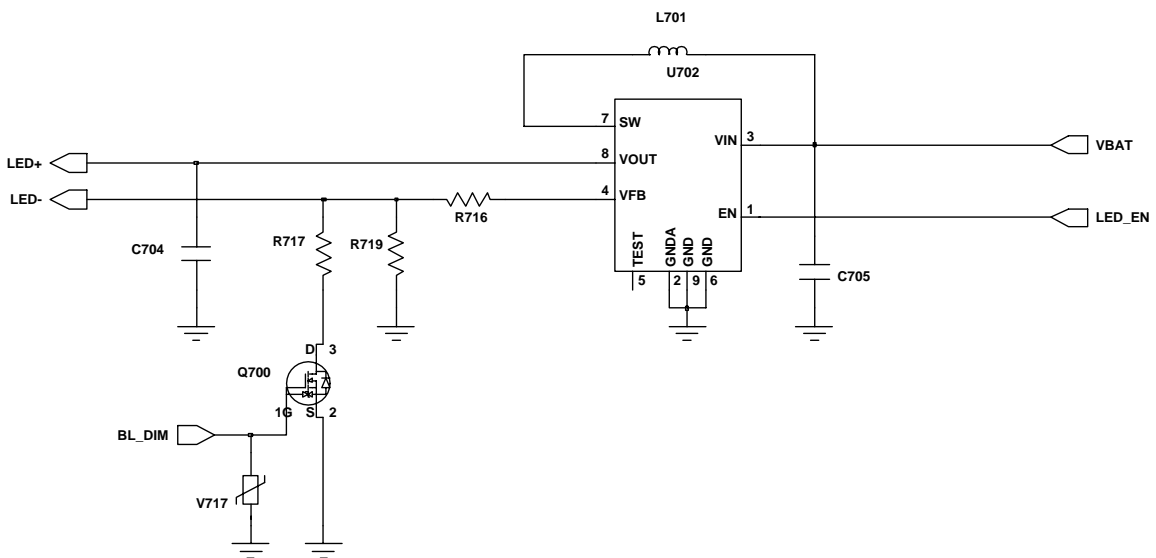
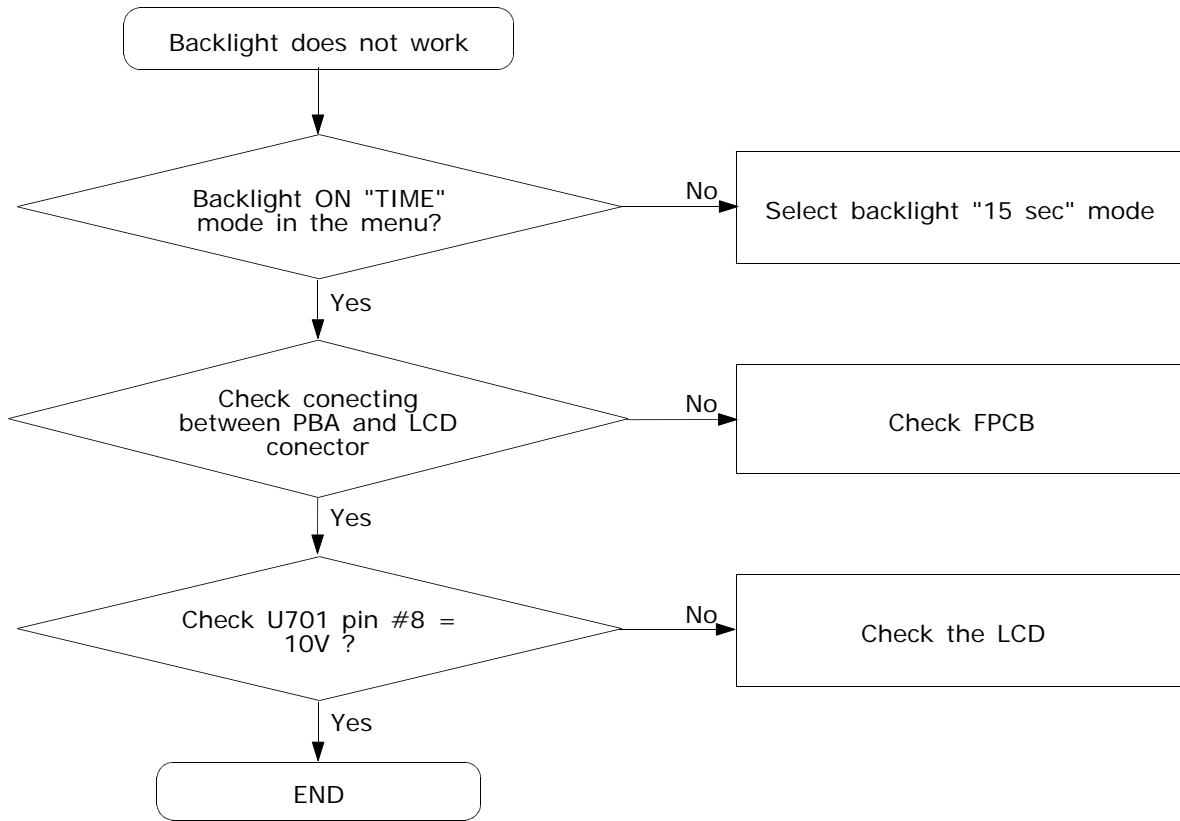

## 2-2. RF

### 2-2-1. GSM Rx

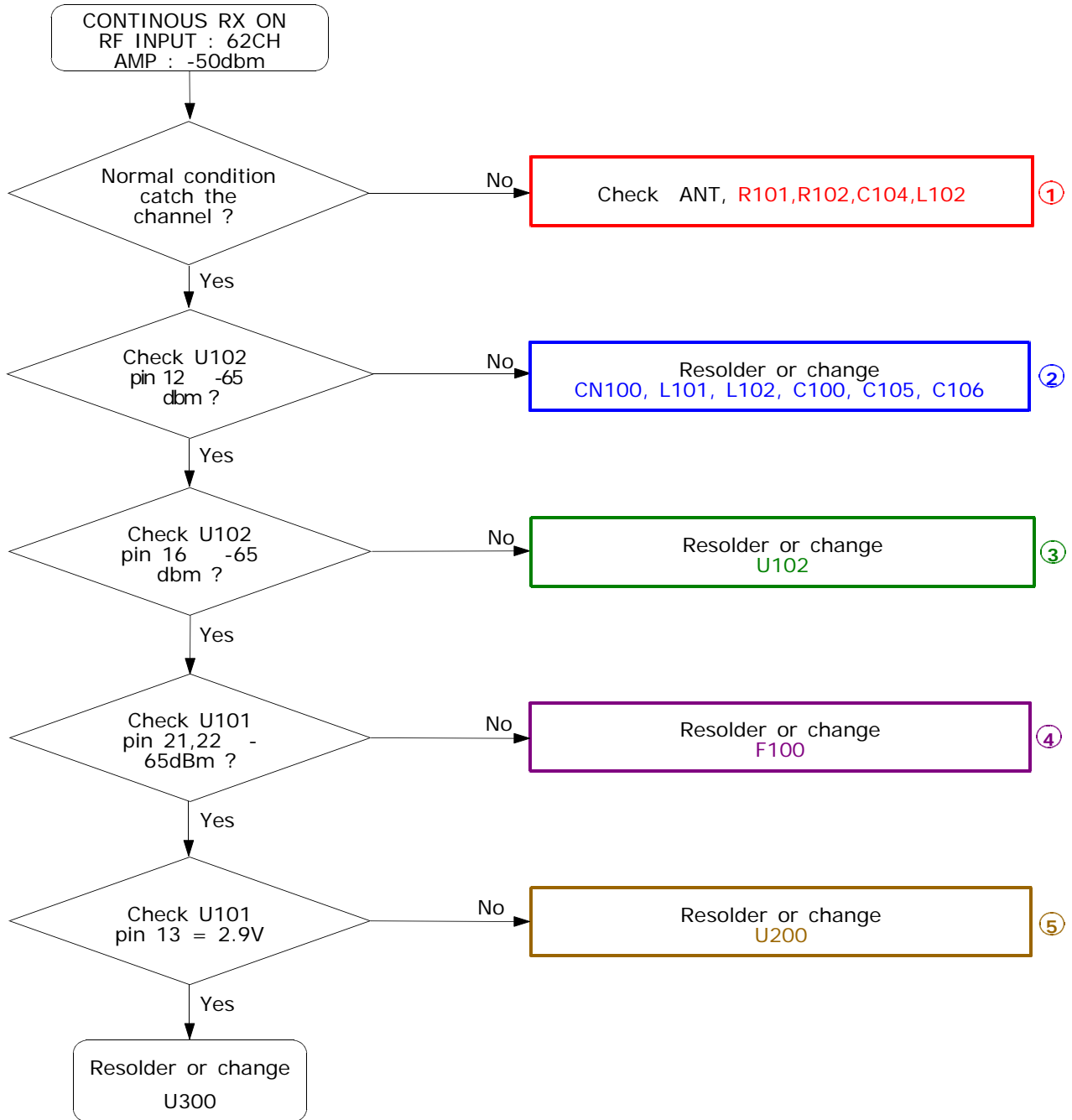

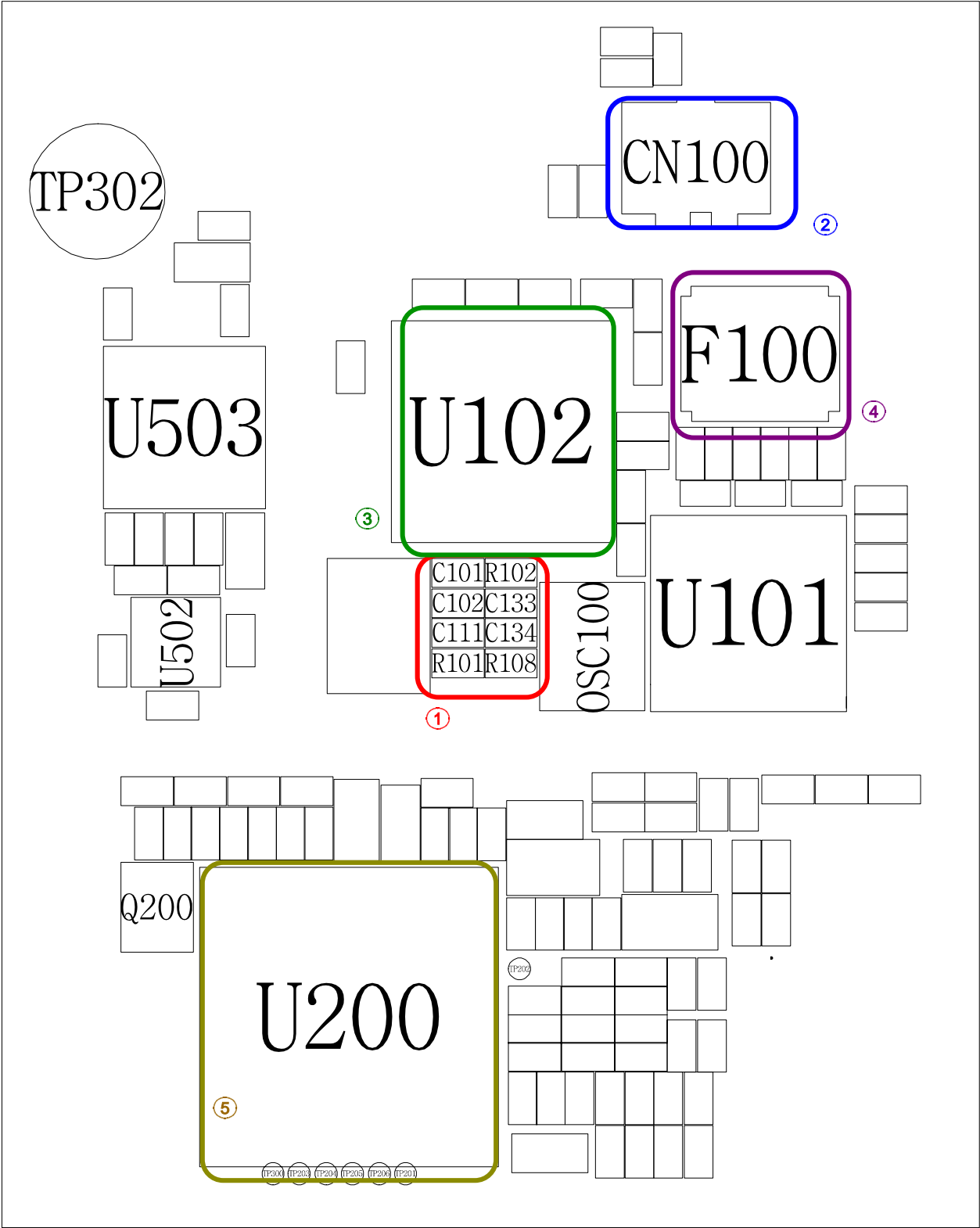

2-2-2. DCS Rx

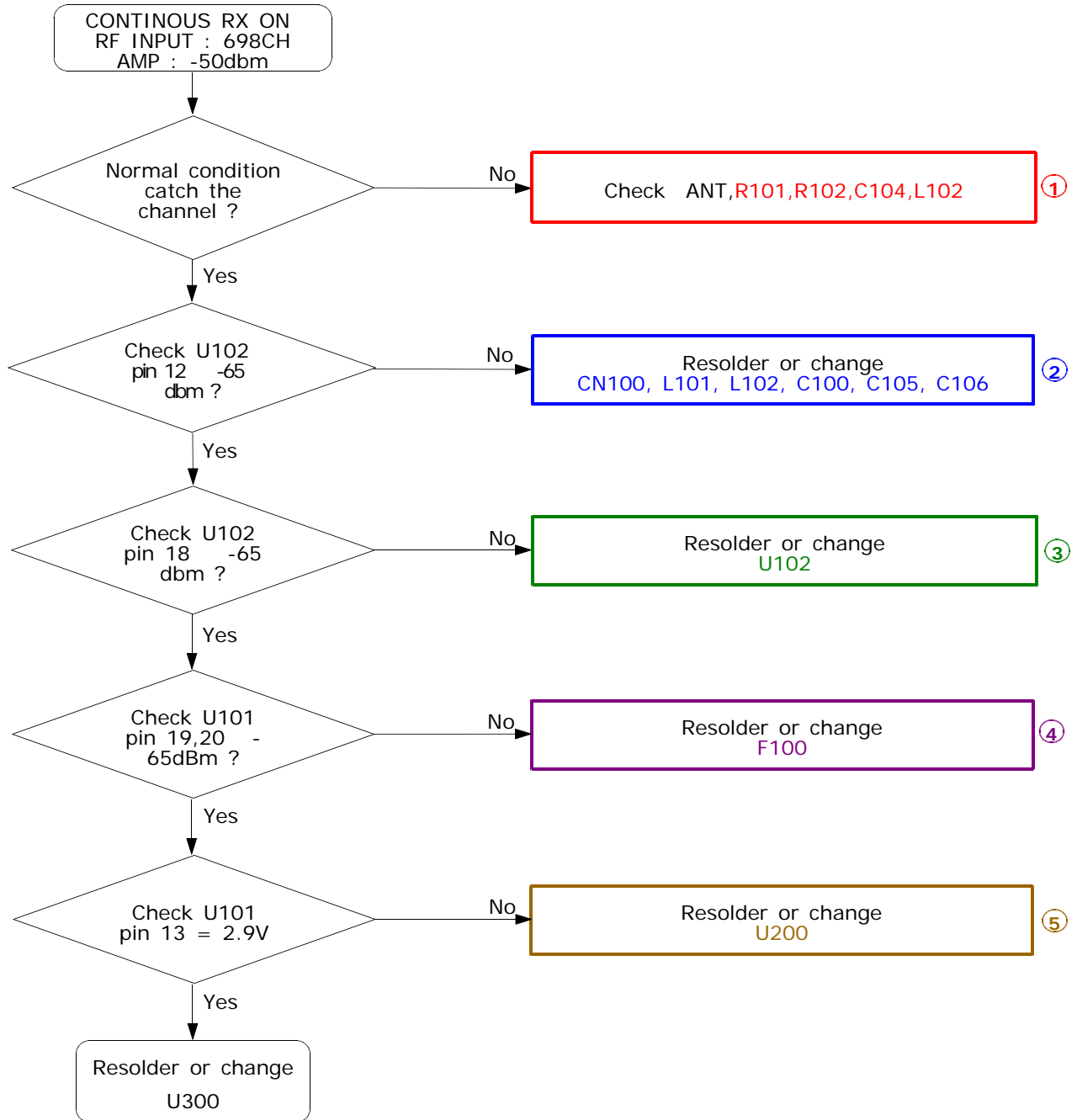

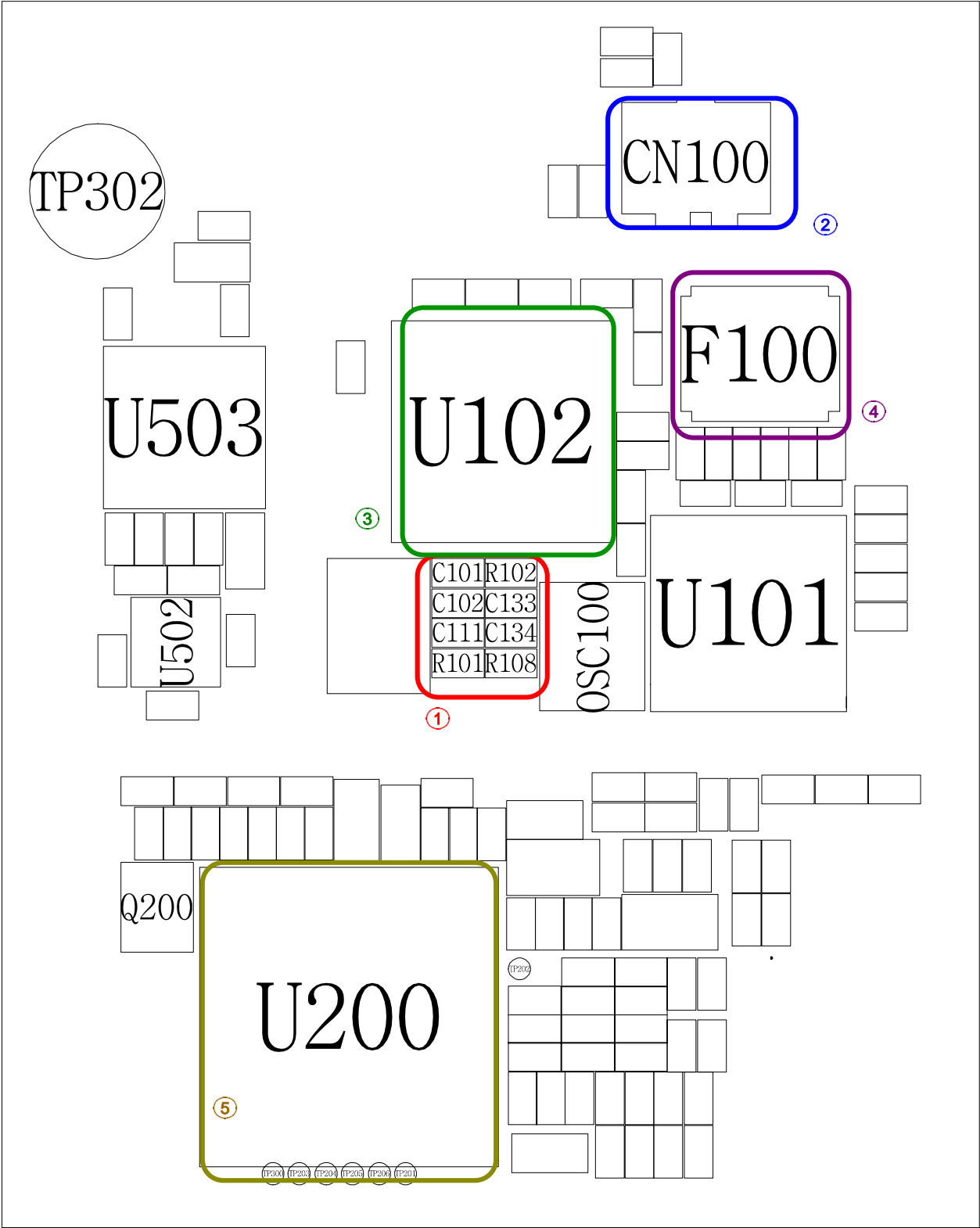

2-2-3. PCS Rx

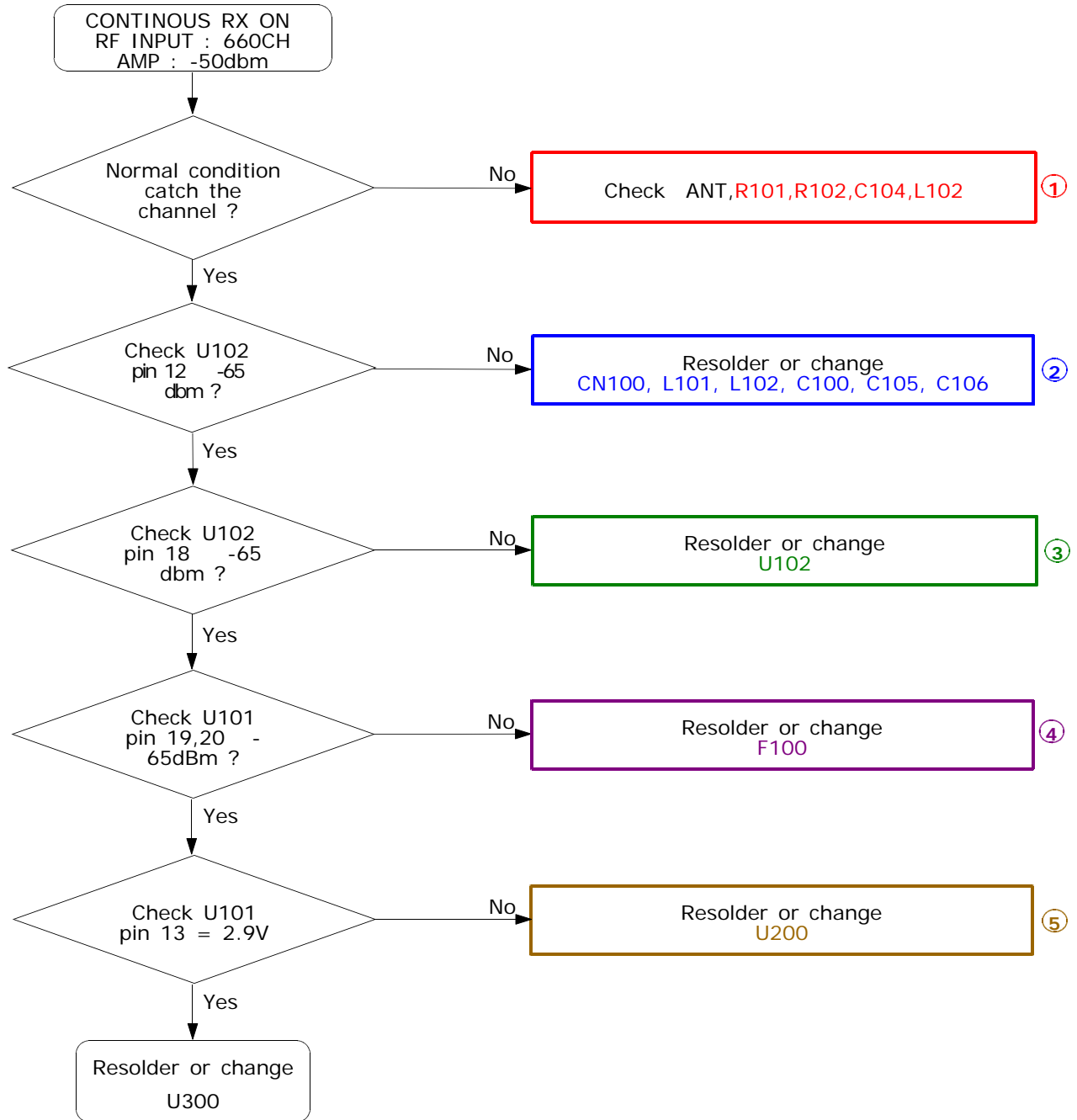

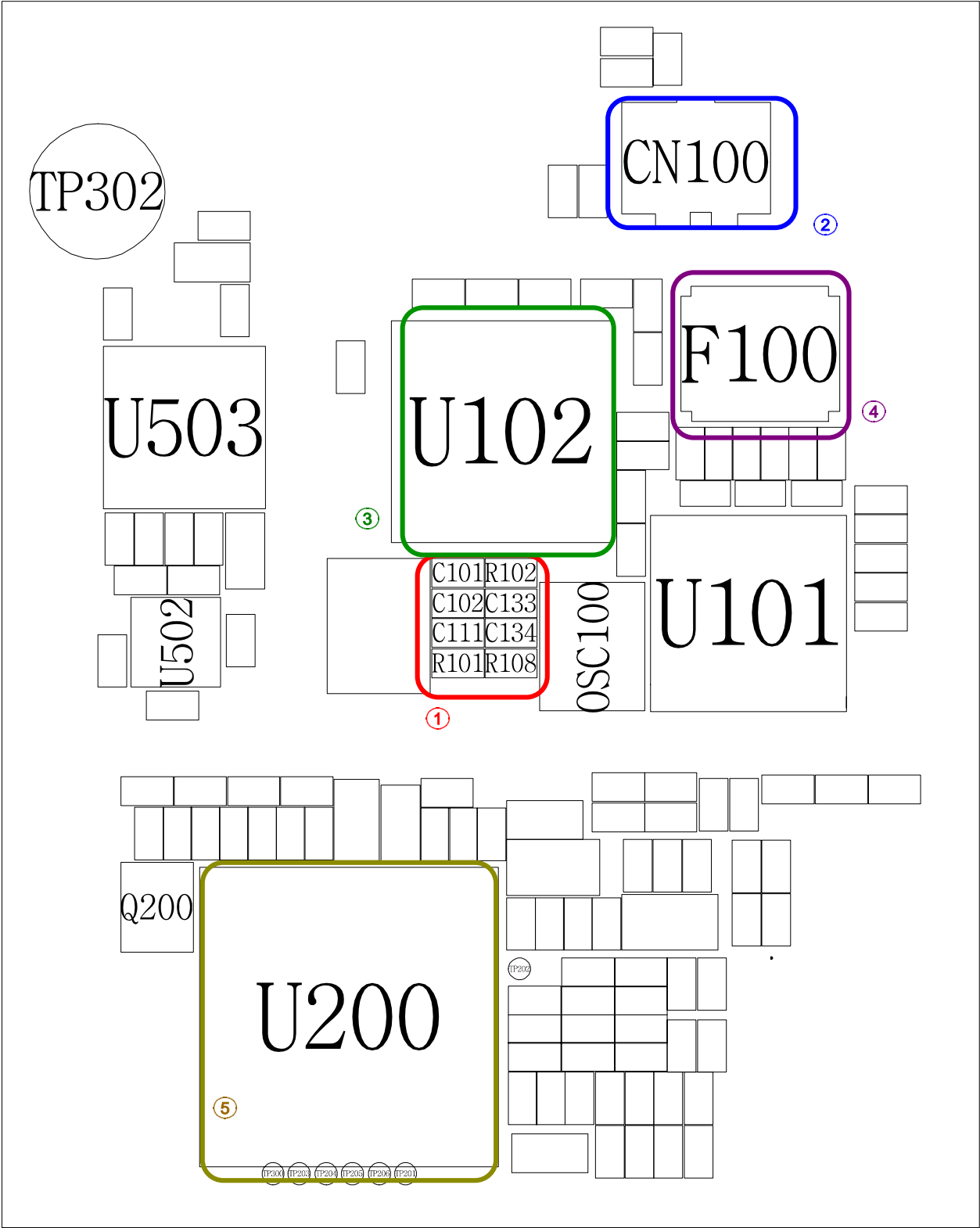



2-2-4. GSM Tx

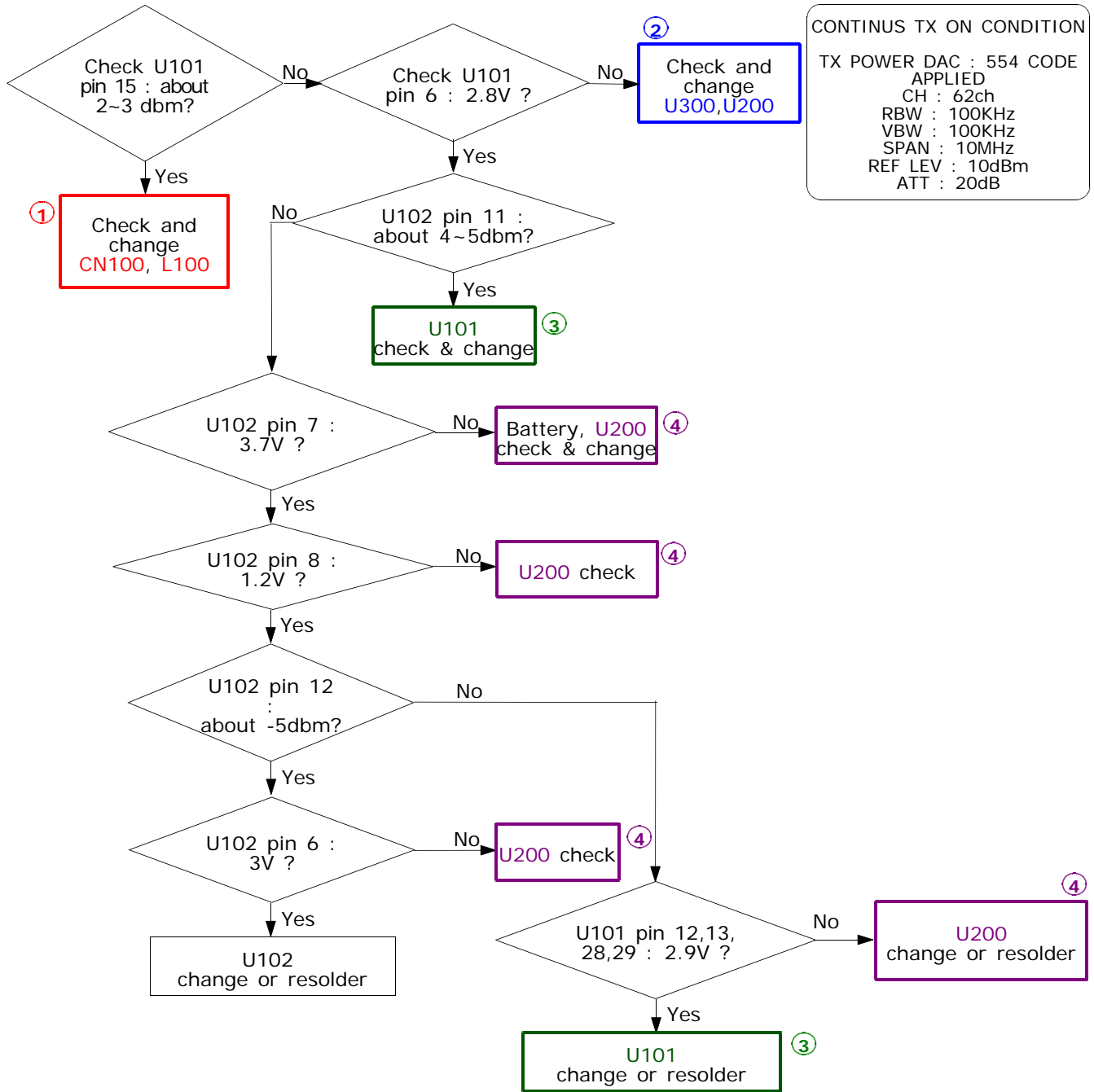

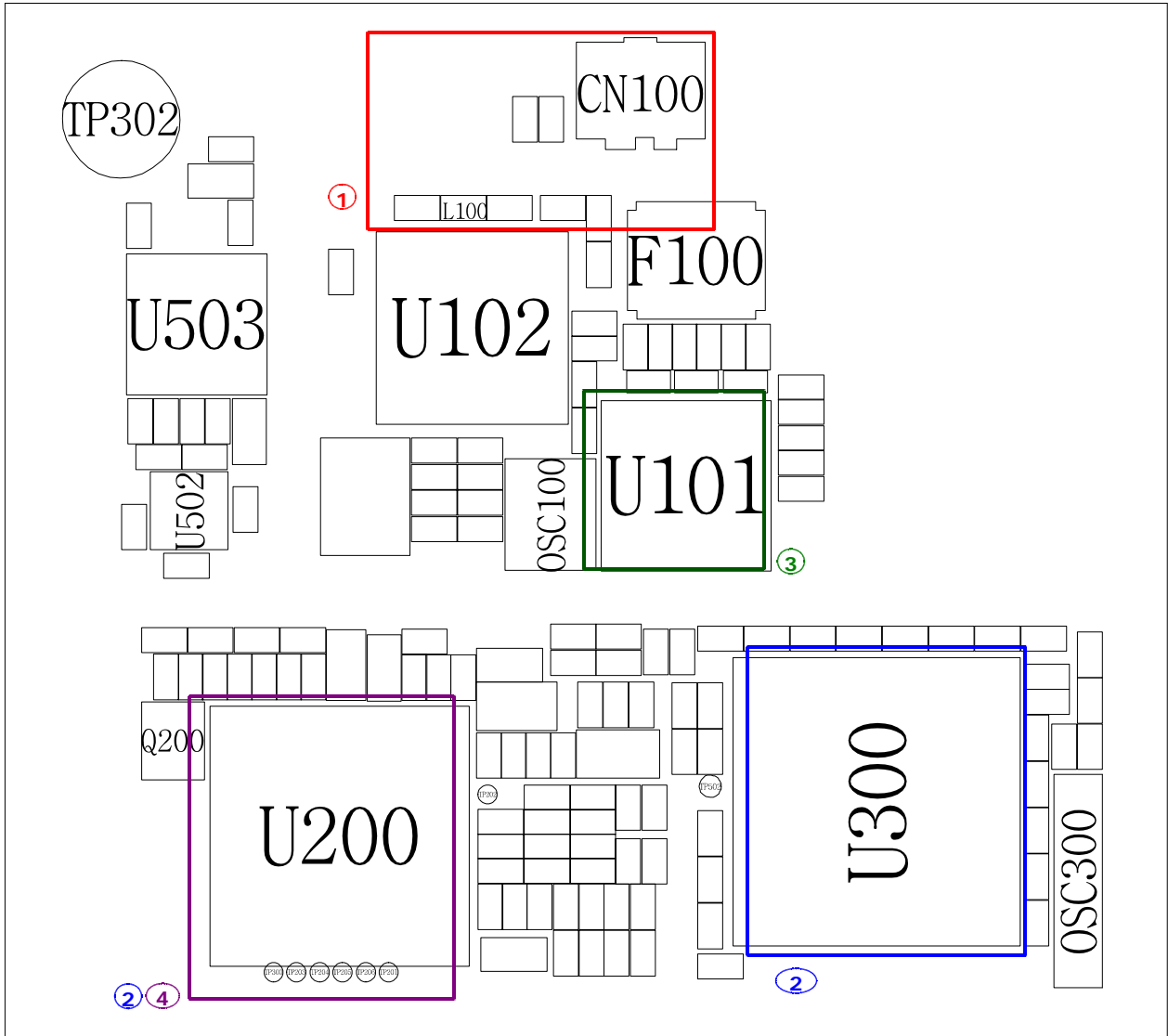

2-2-5. DCS/PCS Tx

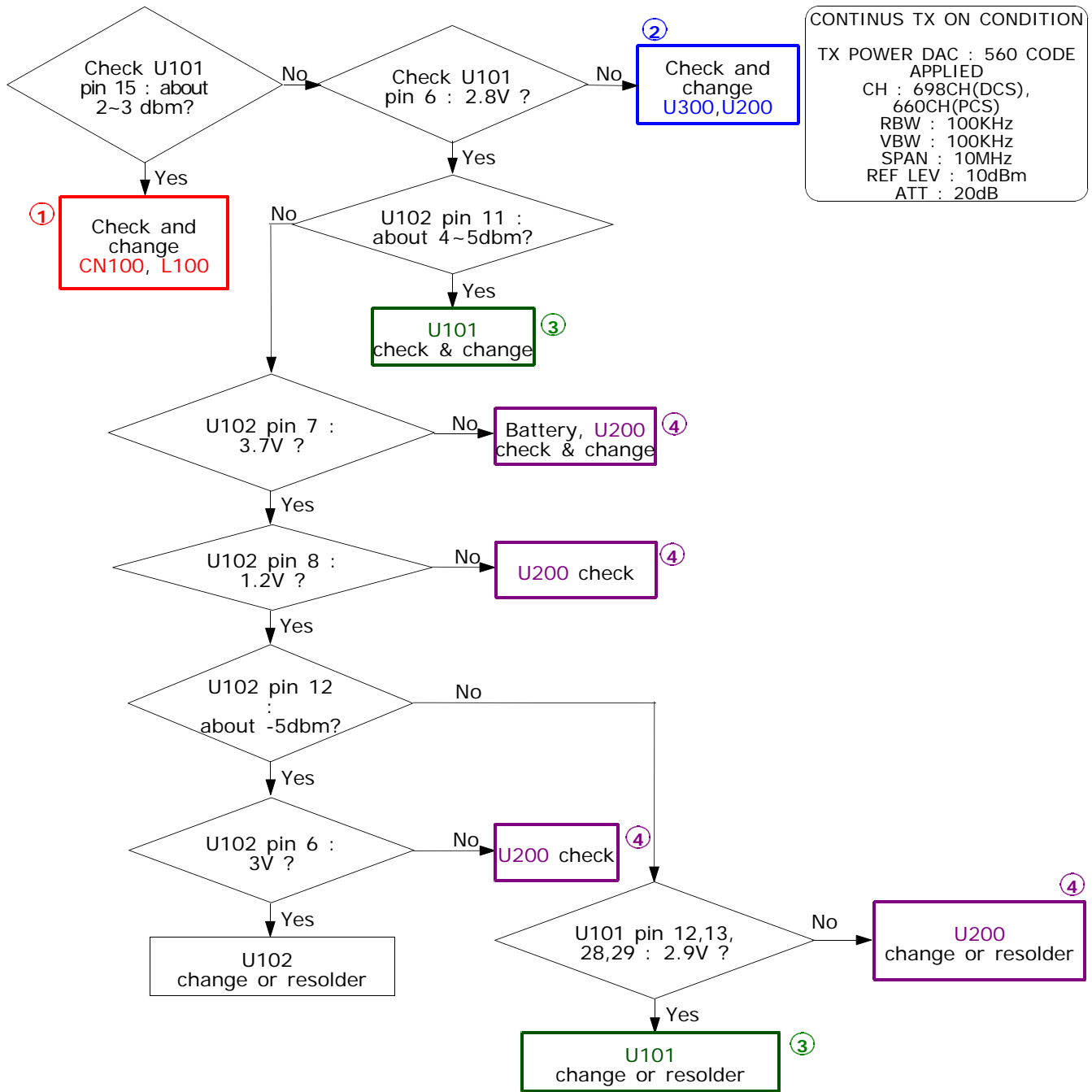

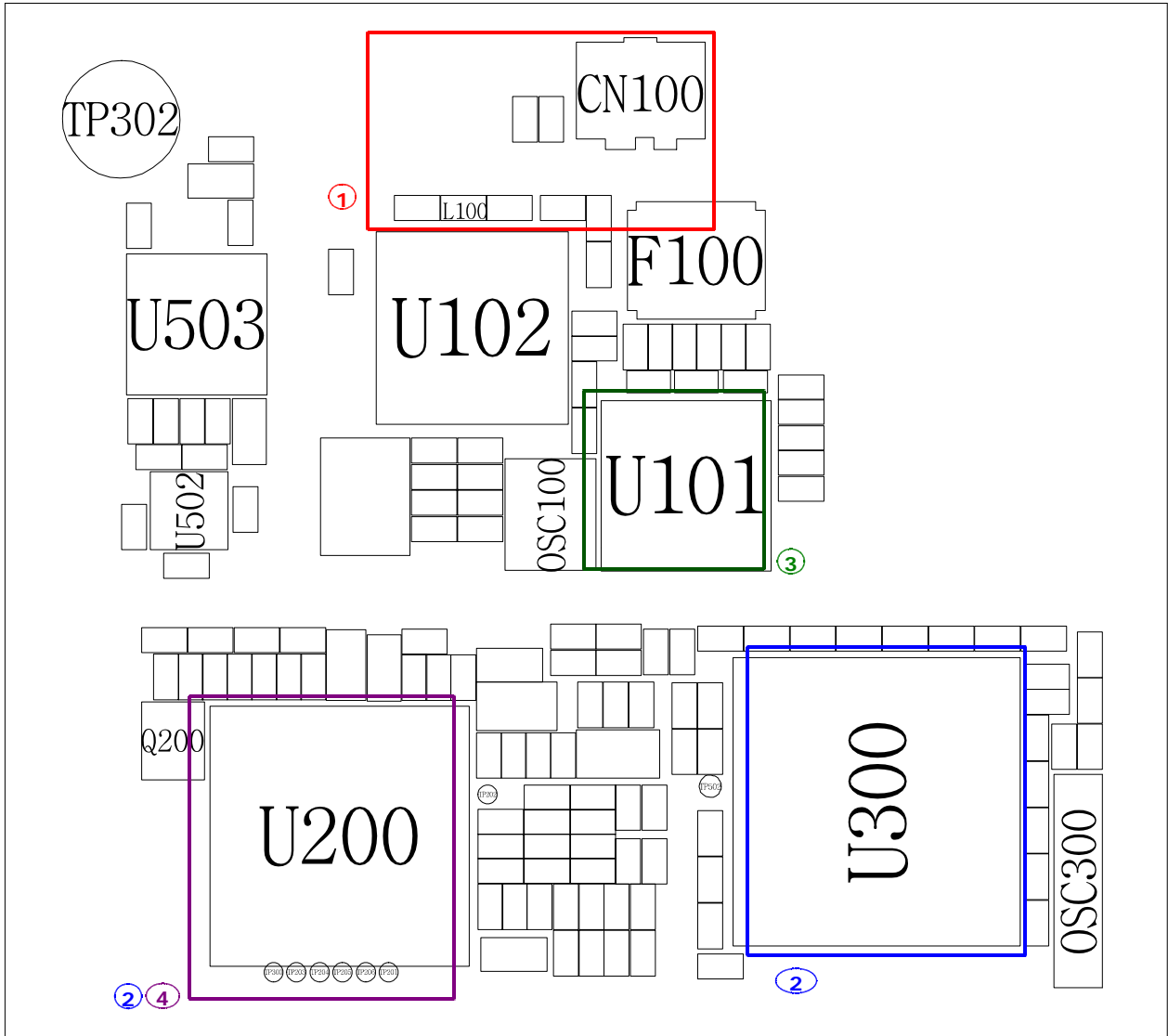

# 3. SGH-X300 Exploded View and Parts List

## 3-1. Cellular phone Exploded View and Parts list

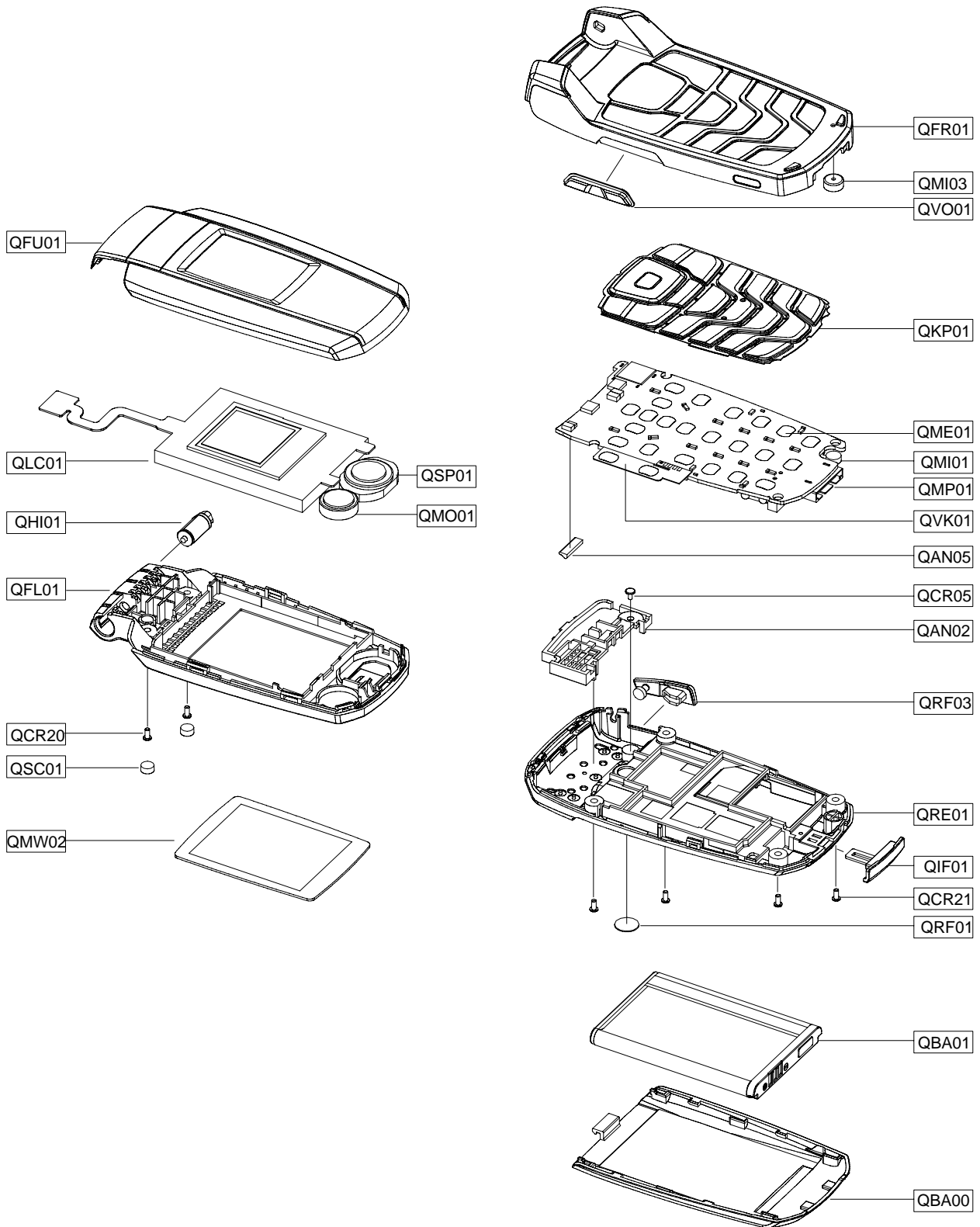

Location No		Description	Sec Code
QAN02		INTENNA-SGHX300	GH42-00747A
QAN05		MEC-INTENNA CONN RUBBER	GH75-08200A
QBA00		PMO-COVER BATT	GH72-27326A
QBA01		INNER BATTERY PACK-800MAH,BLK,	GH43-01850A
QCR05		SCREW-MACHINE	6001-001478
QCR20		SCREW-MACHINE	6001-001429
QCR21		SCREW-MACHINE	6001-001507
QFR01		MEC-CASE FRONT(EU/BLK)	GH75-08746A
QFU01		MEC-CASE F/UPPER(EU/BLK)	GH75-08748A
QIF01		PMO-COVER IF	GH72-27402A
QKP01		MEC-KEYPAD(SER/BLK)	GH75-08870A
QLC01		LCD-LCD MODULE	GH07-00845A
QME01		UNIT-METAL DOME	GH59-02856A
QMI01		MICROPHONE-ASSY-SGHX300	GH30-00242A
QMI03		RMO-RUBBER CUSHION MIC	GH73-05982A
QMO01		MOTOR DC-SGHE720	GH31-00136A
QMP01		PBA MAIN-SGHX300 MAIN	GH92-02546A
QMW02		PCT-COVER MAIN WINDOW	GH72-27405A
QRF01		MPR-TAPE RF CAP	GH74-19651A
QSC01		RMO-RUBBER SCREW CAP	GH73-05981A
QSP01		SPEAKER	3001-001913
QVK01		UNIT-VOLUME KEY	GH59-02857A
QVO01		PMO-VOLUME KEY	GH72-27403A
QFL01		MEC-CASE F/LOWER(EU/BLK)	GH75-08749A
	QHI01	MEC-HINGE ASSY	GH75-09442A
QRE01		MEC-CASE REAR(EU/BLK)	GH75-08747A
	QRF03	PMO-COVER EAR	GH72-27401A

---

<b>Description</b>	<b>Sec Code</b>
BAG PE	6902-000634
ADAPTOR-SGHD500 BLK	GH44-00954A
UNIT-EARPHONE(BLK)	GH59-02472A
LABEL(P)-WATER SOAK	GH68-02026A
MANUAL-WARRANTY CARD	GH68-02623A
MANUAL-SFC	GH68-04336A
LABEL(P)-BARCODE RUSSIA	GH68-08494A
LABEL(R)-MAIN(SER)	GH68-09010D
MANUAL USERS-EU RUSSIAN	GH68-09036A
CUSHION-CASE(1-2)	GH69-03551A
BOX(P)-SGHX300(SER)	GH69-03565E
MPR-VINYL BOHO F/LOWER	GH74-05004B
MPR-BOHO VINYL LCD CONN	GH74-15350A
MPR-TAPE FPCB HOLE	GH74-19652A
MPR-VINYL BOHO LCD	GH74-19660A
MPR-TAPE EMI PBA 1	GH74-21765A
MPR-TAPE EMI PBA 2	GH74-21766A
MPR-TAPE EMI PBA 3	GH74-21767A
MPR-TAPE INSULATION JTAG	GH74-21768A
MPR-TAPE INSULATION PBA	GH74-21769A

### 3-2. Test Jig (GH80-03304A)



3-3-1. RF Test Cable  
(GH39-00283A)



3-3-5. DATA CABLE  
(GH39-00127A)



3-3-3. Serial Cable



3-3-4. Power Supply Cable



3-3-2. Test Cable  
(GH39-00304A)



3-3-6. TA  
(GH44-00954A)



## 4. SGH-X300 MAIN Electrical Parts List

Design LOC	Description	SEC Code	STATUS
BAT20	BATTERY-LI(2ND)	4302-001130	SA
BTC800	HEADER-BATTERY	3711-006084	SA
C101	C-CER,CHIP	2203-002668	SA
C103	C-CER,CHIP	2203-000995	SA
C105	C-CER,CHIP	2203-000254	SA
C107	C-CER,CHIP	2203-005288	SA
C108	C-CER,CHIP	2203-000254	SA
C109	C-CER,CHIP	2203-000438	SA
C111	C-CER,CHIP	2203-002677	SA
C112	C-TA,CHIP	2404-001449	SA
C113	C-CER,CHIP	2203-000254	SA
C114	C-CER,CHIP	2203-000530	SA
C115	C-CER,CHIP	2203-000438	SA
C116	C-CER,CHIP	2203-005482	SA
C117	C-CER,CHIP	2203-000854	SA
C118	C-CER,CHIP	2203-000278	SA
C119	C-CER,CHIP	2203-005234	SA
C120	C-CER,CHIP	2203-000233	SA
C121	C-CER,CHIP	2203-005234	SA
C122	C-CER,CHIP	2203-005234	SA
C123	C-CER,CHIP	2203-005234	SA
C124	C-CER,CHIP	2203-005281	SA
C125	C-CER,CHIP	2203-005281	SA
C126	C-CER,CHIP	2203-005482	SA
C127	C-CER,CHIP	2203-000386	SA
C128	C-CER,CHIP	2203-000812	SA
C129	C-CER,CHIP	2203-005482	SA
C201	C-CER,CHIP	2203-000254	SA
C202	C-CER,CHIP	2203-001072	SA
C203	C-CER,CHIP	2203-005482	SA
C204	C-CER,CHIP	2203-006324	SA
C205	C-CER,CHIP	2203-000812	SA
C206	C-CER,CHIP	2203-000812	SA
C207	C-CER,CHIP	2203-000812	SA
C208	C-CER,CHIP	2203-005061	SA
C209	C-CER,CHIP	2203-006183	SA
C210	C-CER,CHIP	2203-000233	SA
C211	C-TA,CHIP	2404-001240	SA
C212	C-CER,CHIP	2203-006183	SA
C213	C-CER,CHIP	2203-006562	SA
C214	C-CER,CHIP	2203-006562	SA
C215	C-CER,CHIP	2203-006562	SA
C216	C-CER,CHIP	2203-006562	SA
C217	C-CER,CHIP	2203-006562	SA
C218	C-CER,CHIP	2203-000254	SA
C219	C-CER,CHIP	2203-005061	SA
C220	C-CER,CHIP	2203-000254	SA

<b>Design LOC</b>	<b>Discription</b>	<b>SEC Code</b>	<b>STATUS</b>
C221	C-CER,CHIP	2203-005819	SA
C223	C-CER,CHIP	2203-005061	SA
C224	C-TA,CHIP	2404-001415	SA
C225	C-TA,CHIP	2404-001415	SA
C300	C-CER,CHIP	2203-000254	SA
C301	C-CER,CHIP	2203-000254	SA
C302	C-CER,CHIP	2203-000254	SA
C303	C-CER,CHIP	2203-000254	SA
C304	C-CER,CHIP	2203-006260	SA
C305	C-CER,CHIP	2203-005061	SA
C306	C-CER,CHIP	2203-000679	SA
C307	C-CER,CHIP	2203-000254	SA
C308	C-CER,CHIP	2203-001405	SA
C309	C-CER,CHIP	2203-000254	SA
C310	C-CER,CHIP	2203-000254	SA
C311	C-CER,CHIP	2203-000254	SA
C312	C-CER,CHIP	2203-000254	SA
C313	C-CER,CHIP	2203-006260	SA
C315	C-CER,CHIP	2203-000330	SA
C316	C-CER,CHIP	2203-000330	SA
C317	C-CER,CHIP	2203-006626	SA
C401	C-CER,CHIP	2203-000330	SA
C402	C-CER,CHIP	2203-000812	SA
C403	C-CER,CHIP	2203-006260	SA
C404	C-CER,CHIP	2203-000812	SA
C405	C-CER,CHIP	2203-000995	SA
C406	C-CER,CHIP	2203-000628	SA
C407	C-CER,CHIP	2203-000425	SA
C408	C-CER,CHIP	2203-006260	SA
C409	C-CER,CHIP	2203-000330	SA
C410	C-CER,CHIP	2203-000812	SA
C411	C-CER,CHIP	2203-005061	SA
C412	C-TA,CHIP	2404-001414	SA
C413	C-CER,CHIP	2203-000233	SA
C414	C-CER,CHIP	2203-005482	SA
C415	C-TA,CHIP	2404-001415	SA
C417	C-TA,CHIP	2404-001415	SA
C418	C-CER,CHIP	2203-000995	SA
C419	C-CER,CHIP	2203-000278	SA
C420	C-CER,CHIP	2203-005482	SA
C421	C-CER,CHIP	2203-000330	SA
C422	C-CER,CHIP	2203-000330	SA
C424	C-CER,CHIP	2203-000254	SA
C425	C-CER,CHIP	2203-001405	SA
C501	C-CER,CHIP	2203-000940	SA
C502	C-TA,CHIP	2404-001415	SA
C503	C-CER,CHIP	2203-005061	SA

<b>Design LOC</b>	<b>Discription</b>	<b>SEC Code</b>	<b>STATUS</b>
C504	C-CER,CHIP	2203-006091	SA
C506	C-CER,CHIP	2203-006260	SA
C507	C-CER,CHIP	2203-000585	SA
C508	C-CER,CHIP	2203-005061	SA
C509	C-CER,CHIP	2203-005061	SA
C510	C-CER,CHIP	2203-006190	SA
C511	C-CER,CHIP	2203-000438	SA
C512	C-CER,CHIP	2203-006208	SA
C513	C-CER,CHIP	2203-005061	SA
C514	C-CER,CHIP	2203-006562	SA
C515	C-CER,CHIP	2203-000233	SA
C516	C-CER,CHIP	2203-000679	SA
C517	C-CER,CHIP	2203-006257	SA
C518	C-CER,CHIP	2203-006257	SA
C519	C-CER,CHIP	2203-006208	SA
C520	C-CER,CHIP	2203-005482	SA
C521	C-CER,CHIP	2203-001405	SA
C522	C-CER,CHIP	2203-001405	SA
C600	C-CER,CHIP	2203-000233	SA
C601	C-CER,CHIP	2203-005061	SA
C602	C-CER,CHIP	2203-000233	SA
C603	C-CER,CHIP	2203-005061	SA
C604	C-CER,CHIP	2203-000254	SA
C700	C-CER,CHIP	2203-006324	SA
C701	C-CER,CHIP	2203-006361	SA
C702	C-CER,CHIP	2203-005482	SA
C703	C-CER,CHIP	2203-005482	SA
C704	C-TA,CHIP	2404-001450	SA
C705	C-CER,CHIP	2203-006562	SA
C706	C-CER,CHIP	2203-006361	SA
C707	C-CER,CHIP	2203-006208	SA
C708	C-CER,CHIP	2203-006562	SA
C709	C-CER,CHIP	2203-006324	SA
C800	C-CER,CHIP	2203-005482	SA
C801	C-CER,CHIP	2203-000359	SA
C802	C-CER,CHIP	2203-000359	SA
C803	C-CER,CHIP	2203-005482	SA
C804	C-CER,CHIP	2203-000254	SA
C805	C-CER,CHIP	2203-000438	SA
C807	C-CER,CHIP	2203-000854	SA
CON100	CONNECTOR-COAXIAL	3705-001358	SA
D714	DIODE-TV5	0406-001210	SA
D715	DIODE-TV5	0406-001210	SA
D716	DIODE-TV5	0406-001210	SA
EAR400	JACK-EAR PHONE	3722-002356	SA
F100	DUPLEXER-FEM	2911-000030	SNA
F800	FILTER-EMI SMD	2901-001311	SA

<b>Design LOC</b>	<b>Discription</b>	<b>SEC Code</b>	<b>STATUS</b>
F801	FILTER-EMI SMD	2901-001311	SA
F802	FILTER-EMI SMD	2901-001311	SA
HDC800	HEADER-BOARD TO BOARD	3711-006118	SNA
IFC803	CONNECTOR-INTERFACE	3710-001611	SA
IRD710	PHOTO-IRDA	0604-001306	SA
L101	NPR-ANTENNA CONTACT	GH71-04813A	SA
L101	NPR-ANTENNA CONTACT	GH71-04813A	SA
L103	INDUCTOR-SMD	2703-002269	SA
L104	INDUCTOR-SMD	2703-002207	SA
L105	INDUCTOR-SMD	2703-002208	SA
L107	INDUCTOR-SMD	2703-002544	SA
L108	INDUCTOR-SMD	2703-002544	SA
L109	INDUCTOR-SMD	2703-002558	SA
L110	INDUCTOR-SMD	2703-002200	SA
L111	INDUCTOR-SMD	2703-001750	SA
L401	INDUCTOR-SMD	2703-002202	SA
L402	INDUCTOR-SMD	2703-002202	SA
L403	BEAD-SMD	3301-001729	SA
L404	BEAD-SMD	3301-001729	SA
L405	BEAD-SMD	3301-001729	SA
L406	BEAD-SMD	3301-001729	SA
L407	BEAD-SMD	3301-001729	SA
L408	BEAD-SMD	3301-001729	SA
L501	INDUCTOR-SMD	2703-001513	SA
L700	BEAD-SMD	3301-001729	SA
L701	INDUCTOR-SMD	2703-000403	SA
L800	BEAD-SMD	3301-001659	SA
LED700	LED	0601-002037	SA
LED701	LED	0601-002037	SA
LED702	LED	0601-002037	SA
LED703	LED	0601-002037	SA
LED704	LED	0601-002037	SA
LED705	LED	0601-002037	SA
LED706	LED	0601-002037	SA
LED707	LED	0601-002037	SA
LED708	LED	0601-002037	SA
LED709	LED	0601-002037	SA
LED710	LED	0601-002037	SA
LED711	LED	0601-002037	SA
LED712	LED	0601-002037	SA
LED713	LED	0601-002037	SA
LED714	LED	0601-002037	SA
LED715	LED	0601-002037	SA
OSC100	CRYSTAL-SMD	2801-004426	SA
OSC300	CRYSTAL-SMD	2801-003856	SA
R101	R-CHIP	2007-001298	SA
R102	R-CHIP	2007-002970	SA

<b>Design LOC</b>	<b>Discription</b>	<b>SEC Code</b>	<b>STATUS</b>
R103	R-CHIP	2007-000171	SA
R104	R-CHIP	2007-007306	SA
R105	R-CHIP	2007-000171	SA
R106	R-CHIP	2007-002797	SA
R107	R-CHIP	2007-000148	SA
R108	R-CHIP	2007-001308	SA
R109	R-CHIP	2007-000171	SA
R201	R-CHIP	2007-007142	SA
R202	R-CHIP	2007-000171	SA
R203	R-CHIP	2007-000162	SA
R204	R-CHIP	2007-000171	SA
R205	R-CHIP	2007-000171	SA
R206	R-CHIP	2007-000171	SA
R207	R-CHIP	2007-000171	SA
R208	R-CHIP	2007-000171	SA
R209	R-CHIP	2007-000171	SA
R210	R-CHIP	2007-000167	SA
R211	R-CHIP	2007-000172	SA
R213	R-CHIP	2007-000172	SA
R214	R-CHIP	2007-000162	SA
R216	R-CHIP	2007-007142	SA
R217	R-CHIP	2007-000154	SA
R218	R-CHIP	2007-000153	SA
R219	R-CHIP	2007-000162	SA
R220	R-CHIP	2007-000140	SA
R301	R-CHIP	2007-000157	SA
R302	R-CHIP	2007-000157	SA
R303	R-CHIP	2007-000162	SA
R304	R-CHIP	2007-000171	SA
R305	R-CHIP	2007-007480	SA
R306	R-CHIP	2007-000157	SA
R307	R-CHIP	2007-000159	SA
R308	R-CHIP	2007-007142	SA
R309	R-CHIP	2007-000171	SA
R310	R-CHIP	2007-007573	SA
R311	R-CHIP	2007-000162	SA
R312	R-CHIP	2007-007573	SA
R313	R-CHIP	2007-000143	SA
R314	R-CHIP	2007-000143	SA
R315	R-CHIP	2007-000140	SA
R401	R-CHIP	2007-000162	SA
R402	R-CHIP	2007-007107	SA
R403	R-CHIP	2007-007142	SA
R404	R-CHIP	2007-000174	SA
R405	R-CHIP	2007-000148	SA
R406	R-CHIP	2007-000174	SA
R407	R-CHIP	2007-007142	SA

<b>Design LOC</b>	<b>Discription</b>	<b>SEC Code</b>	<b>STATUS</b>
R408	R-CHIP	2007-000171	SA
R409	R-CHIP	2007-007107	SA
R410	R-CHIP	2007-001320	SA
R411	R-CHIP	2007-000142	SA
R412	R-CHIP	2007-000171	SA
R413	R-CHIP	2007-001317	SA
R414	R-CHIP	2007-000171	SA
R415	R-CHIP	2007-001320	SA
R416	R-CHIP	2007-000142	SA
R417	R-CHIP	2007-007142	SA
R418	R-CHIP	2007-007101	SA
R419	R-CHIP	2007-007101	SA
R420	R-CHIP	2007-007142	SA
R421	R-CHIP	2007-007573	SA
R422	R-CHIP	2007-007480	SA
R423	R-CHIP	2007-001339	SA
R424	R-CHIP	2007-000162	SA
R425	R-CHIP	2007-001317	SA
R500	R-CHIP	2007-000171	SA
R501	R-CHIP	2007-007021	SA
R502	R-CHIP	2007-007090	SA
R503	R-CHIP	2007-000151	SA
R504	R-CHIP	2007-001325	SA
R505	R-CHIP	2007-000161	SA
R506	R-CHIP	2007-000152	SA
R507	R-CHIP	2007-000152	SA
R508	R-CHIP	2007-000171	SA
R509	R-CHIP	2007-000161	SA
R510	R-CHIP	2007-000162	SA
R511	R-CHIP	2007-001291	SA
R512	R-CHIP	2007-001291	SA
R513	R-CHIP	2007-000171	SA
R514	R-CHIP	2007-000171	SA
R515	R-CHIP	2007-000171	SA
R600	R-CHIP	2007-000172	SA
R601	R-CHIP	2007-000171	SA
R701	R-CHIP	2007-003004	SA
R702	R-CHIP	2007-003004	SA
R703	R-CHIP	2007-003004	SA
R704	R-CHIP	2007-003004	SA
R705	R-CHIP	2007-003004	SA
R706	R-CHIP	2007-003004	SA
R707	R-CHIP	2007-003004	SA
R708	R-CHIP	2007-003004	SA
R709	R-CHIP	2007-003004	SA
R710	R-CHIP	2007-003004	SA
R711	R-CHIP	2007-000138	SA

<b>Design LOC</b>	<b>Discription</b>	<b>SEC Code</b>	<b>STATUS</b>
R712	R-CHIP	2007-003004	SA
R713	R-CHIP	2007-003004	SA
R714	R-CHIP	2007-003004	SA
R715	R-CHIP	2007-000138	SA
R716	R-CHIP	2007-003004	SA
R717	R-CHIP	2007-000162	SA
R718	R-CHIP	2007-000171	SA
R719	R-CHIP	2007-001291	SA
R720	R-CHIP	2007-000162	SA
R721	R-CHIP	2007-000140	SA
R722	R-CHIP	2007-001294	SA
R723	R-CHIP	2007-001284	SA
R724	R-CHIP	2007-000138	SA
R800	R-CHIP	2007-000172	SA
R801	R-CHIP	2007-000566	SA
R802	R-CHIP	2007-000566	SA
R803	R-CHIP	2007-000566	SA
R804	R-CHIP	2007-000566	SA
R805	R-CHIP	2007-000566	SA
R806	R-CHIP	2007-000140	SA
R807	R-CHIP	2007-000140	SA
R808	R-CHIP	2007-000140	SA
R809	R-CHIP	2007-000140	SA
R810	R-CHIP	2007-000140	SA
R811	R-CHIP	2007-000140	SA
R812	R-CHIP	2007-000140	SA
R813	R-CHIP	2007-000140	SA
R814	R-CHIP	2007-000140	SA
R815	R-CHIP	2007-000140	SA
R816	R-CHIP	2007-000171	SA
R817	R-CHIP	2007-000140	SA
R818	R-CHIP	2007-000140	SA
SIM200	CONNECTOR-CARD EDGE	3709-001229	SA
TA800	C-TA,CHIP	2404-001415	SA
TH300	THERMISTOR-NTC	1404-001221	SA
TR200	TR-DIGITAL	0504-000168	SA
TR700	FET-SILICON	0505-001518	SA
U101	IC-TRANSCIEVER	1205-002683	SA
U102	IC-POWER AMP	1201-002218	SA
U201	IC-BATTERY	1203-003663	SA
U202	IC-CMOS LOGIC	0801-000796	SA
U400	IC-ANALOG SWITCH	1001-001371	SA
U401	IC-VOLTAGE COMP.	1202-001068	SA
U500	IC-MELODY	1204-002161	SA
U501	IC-ANALOG SWITCH	1001-001231	SA
U502	IC-AUDIO AMP	1201-002348	SA
U503	IC-TUNER	1204-002510	SA

<b>Design LOC</b>	<b>Discription</b>	<b>SEC Code</b>	<b>STATUS</b>
U504	IC-ANALOG SWITCH	1001-001371	SA
U701	IC-HALL EFFECT S/W	1009-001010	SA
U702	IC-DC/DC CONVERTER	1203-004004	SA
U703	IC-POSI.FIXED REG.	1203-003754	SA
UCP200	IC-POWER SUPERVISOR	1203-003304	SA
UCP300	IC MICOM-SGHX480	GH09-00036A	SA
UME600	IC-MCP	1108-000010	SA
VR401	VARISTOR	1405-001082	SA
VR402	VARISTOR	1405-001082	SA
VR403	VARISTOR	1405-001082	SA
VR404	VARISTOR	1405-001082	SA
VR405	VARISTOR	1405-001082	SA
VR701	VARISTOR	1405-001082	SA
VR702	DIODE-TVS	0406-001231	SA
VR703	DIODE-TVS	0406-001231	SA
VR704	DIODE-TVS	0406-001231	SA
VR705	DIODE-TVS	0406-001231	SA
VR706	DIODE-TVS	0406-001231	SA
VR707	DIODE-TVS	0406-001231	SA
VR708	DIODE-TVS	0406-001231	SA
VR709	DIODE-TVS	0406-001231	SA
VR710	DIODE-TVS	0406-001231	SA
VR711	DIODE-TVS	0406-001231	SA
VR712	DIODE-TVS	0406-001231	SA
VR713	VARISTOR	1405-001082	SA
VR717	VARISTOR	1405-001110	SA
VR718	DIODE-TVS	0406-001231	SA
VR800	VARISTOR	1405-001082	SA
ZD400	DIODE-TVS	0406-001104	SA
ZD800	DIODE-ZENER	0403-001547	SA
ZD801	DIODE-ZENER	0403-001427	SA
ZD802	DIODE-TVS	0406-001190	SA
ZD803	DIODE-TVS	0406-001190	SA
ZD804	DIODE-TVS	0406-001190	SA
ZD805	DIODE-ZENER	0403-001547	SA



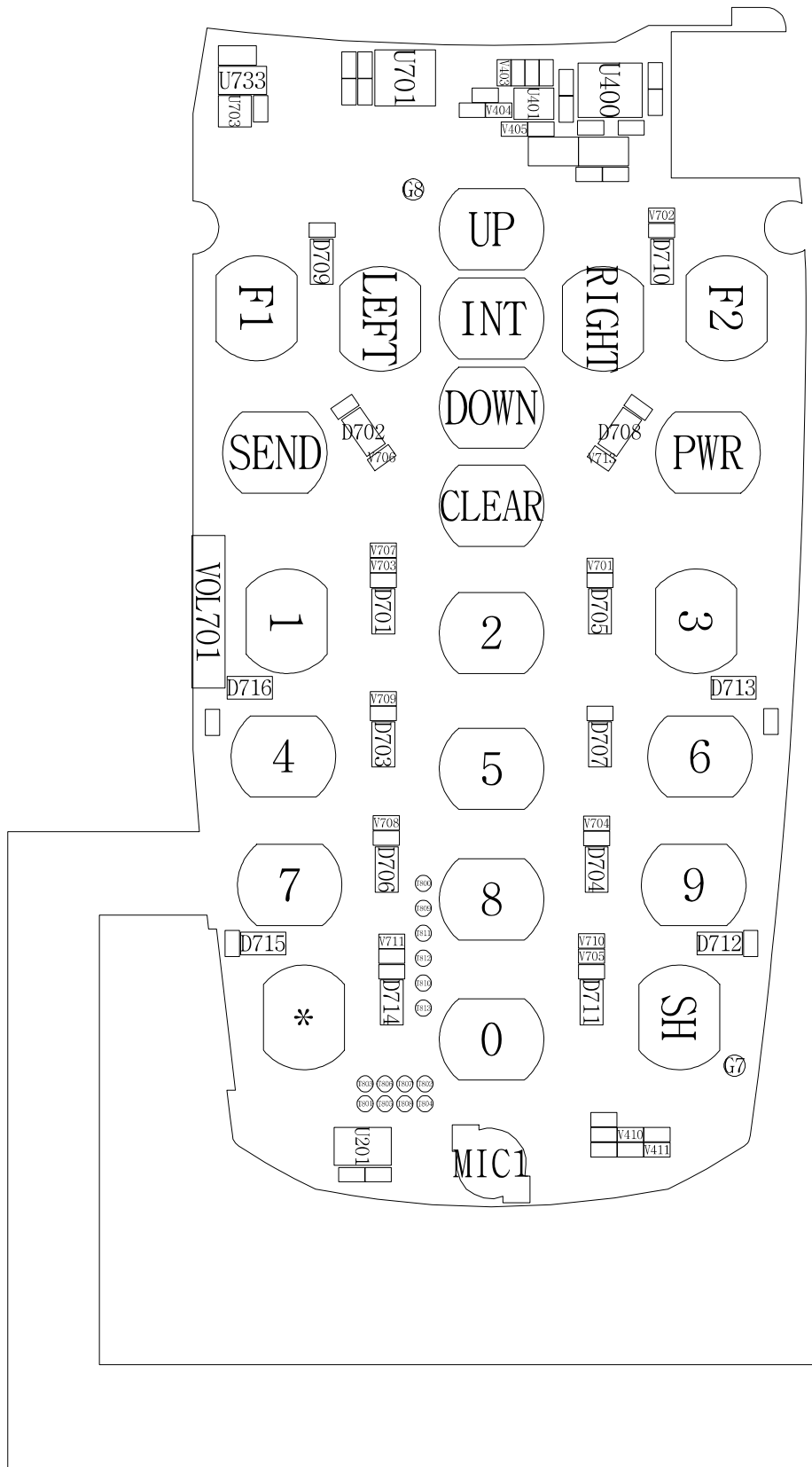

## 6. SGH-X300 Block Diagrams

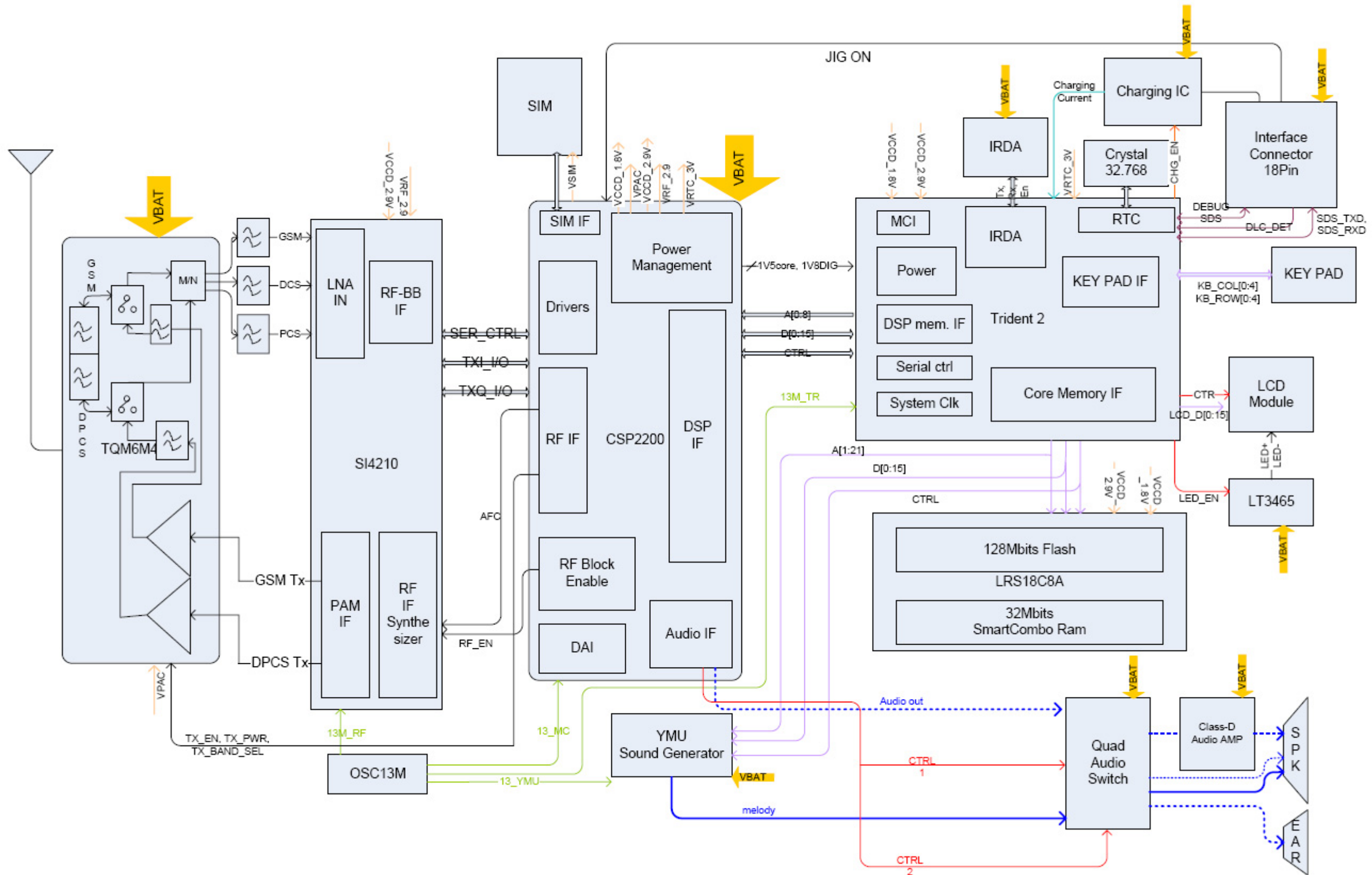

# Disassembling Manual

1

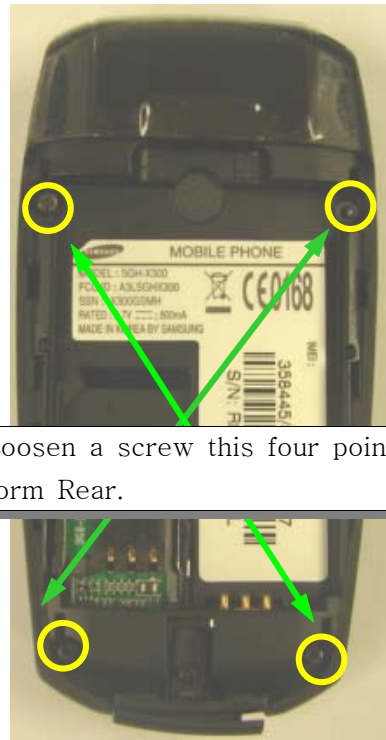

1) Loosen a screw this four point form Rear.

1) Be care of scratch and molding damage.

2



1) It uses assembly stick and the HOOK of the right side lower part confidential talk it disjoints with the outer side which it will call.



2) The HOOK gets wider and it catches it lifts it disjoints with REAR by the hand.

1) When we disjoint Rear, be care of scratch and molding damage.

3

1) After connector we disjoining PBA.  
2) Remove the foreign object projection Tape.

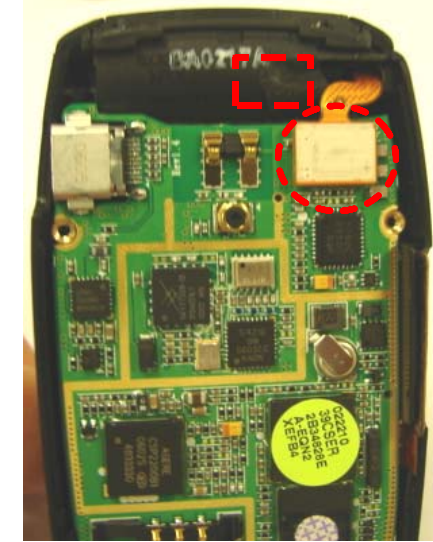

1) When we disjoining a connector and PBA, be care of damage.

4



1) Separate the Keypad.  
2) Push the hinge and disjoint from Front.

1) When we disjoint the Front, be care of body transformation.

5



1) Remove a screw cap by using a pinset.  
2) Loosen a screw by using a driver.

1) Be care of scratch.

6

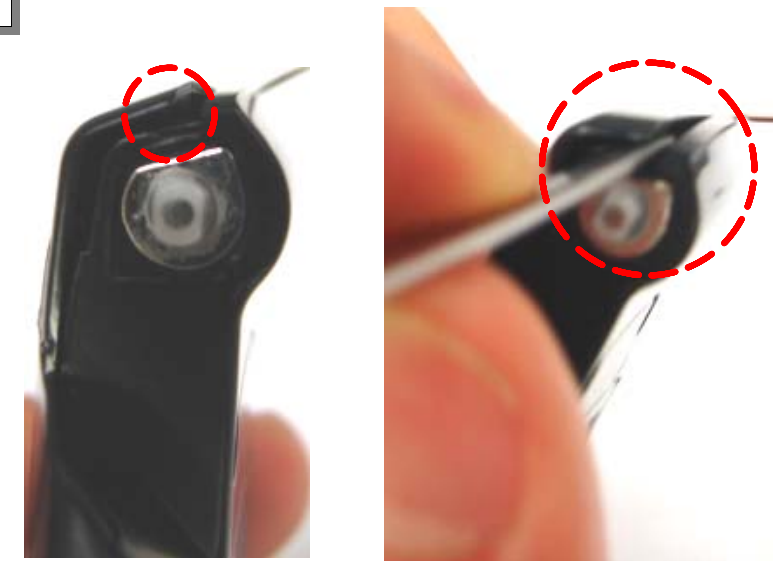

1) Insert a pinset in a separate home and disjoint Folder Upper high position.

1) Be care of scratch and molding damage.

7



1) By using a assembly stick we disjoint between Folder Upper and lower (it's same process right and left)

1) Be care of scratch and molding damage.

8



1) Remove a EMI tape by using a pinset.

1) Be care of scratch and molding damage.

9

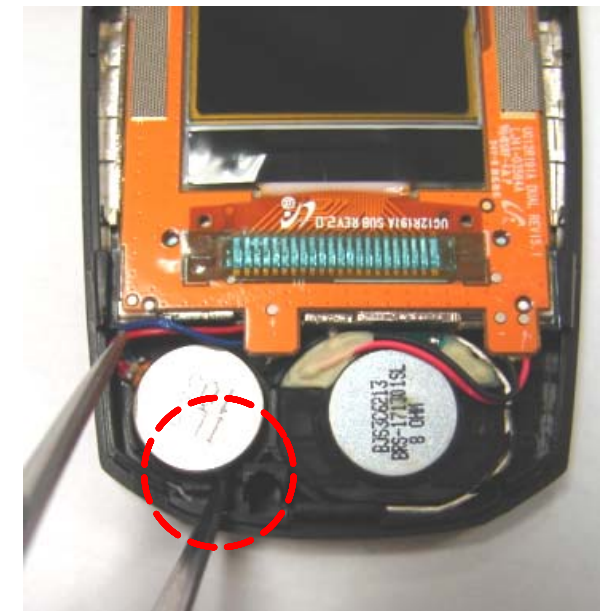

1) Remove a Motor tape by using a pinset.

1) Be care of scratch and molding damage.

10

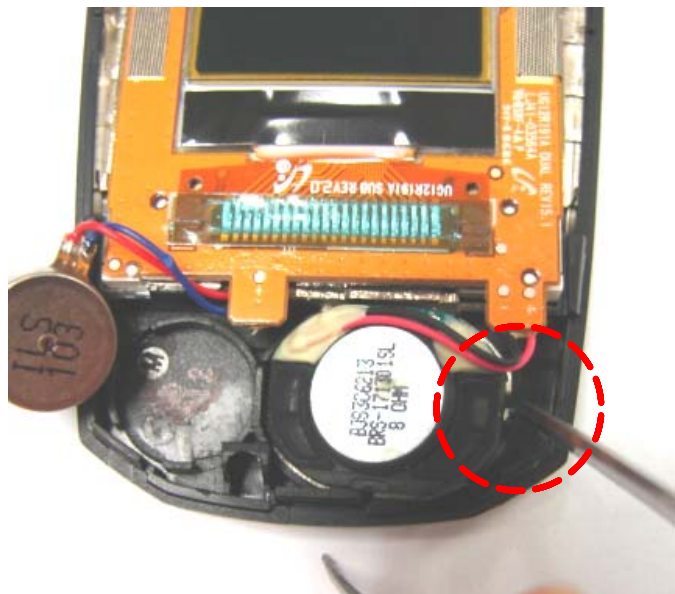

1) Remove a speaker by using a pinset.

1) Be care of scratch and molding damage.

# Assembling Manual

1

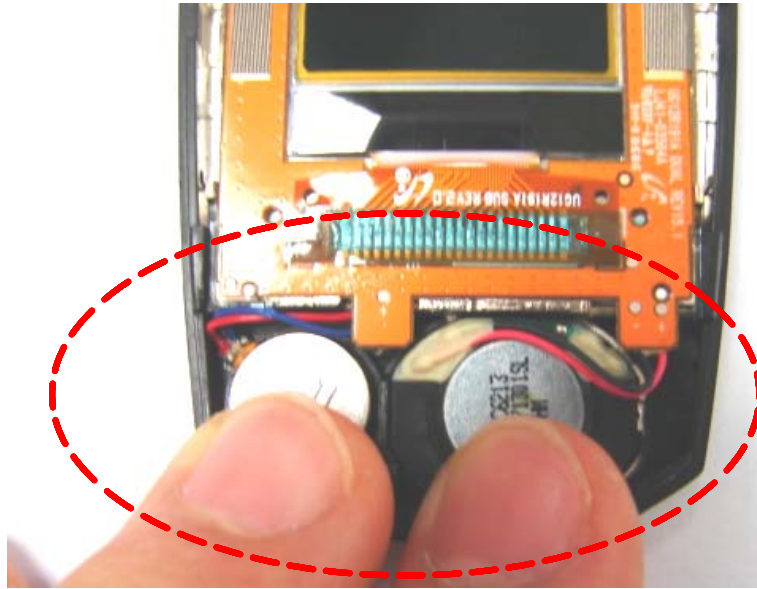

1) Inter a Motor and Speaker and pushing.

1) Be care of wire arrangement and damage.

2

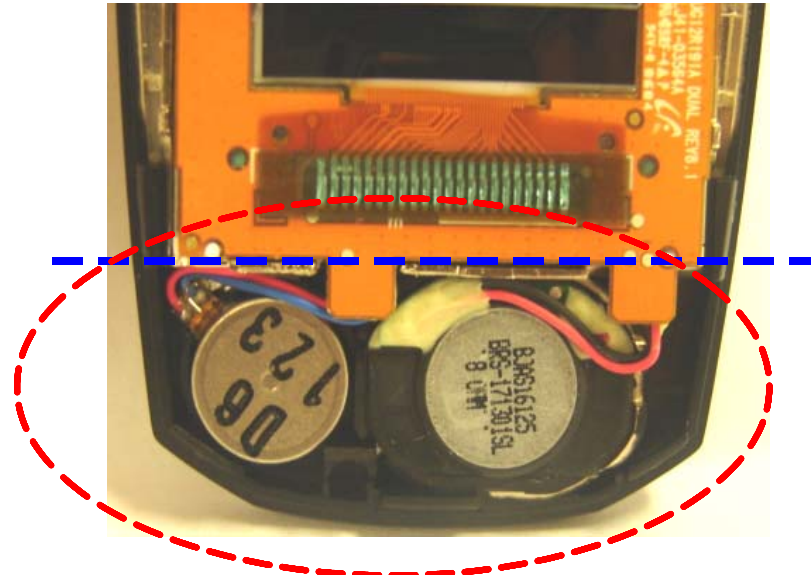

1) Wire must not rid on LCD bracket guide.  
The wire arrangement must be like this picture.

1) Be care of wire arrangement and damage.

3

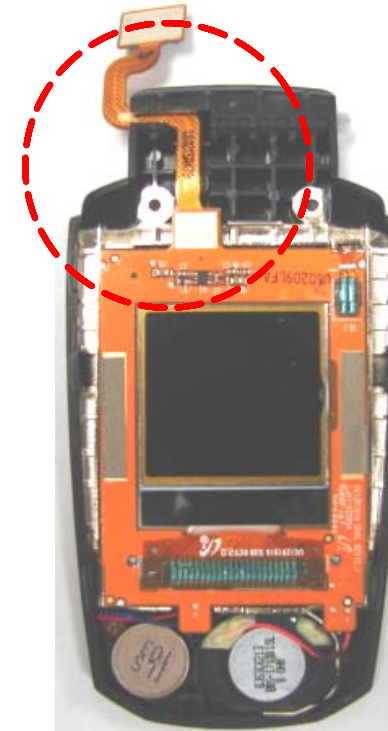

1) Insert the FPCB at hole and fixed LCD.

4

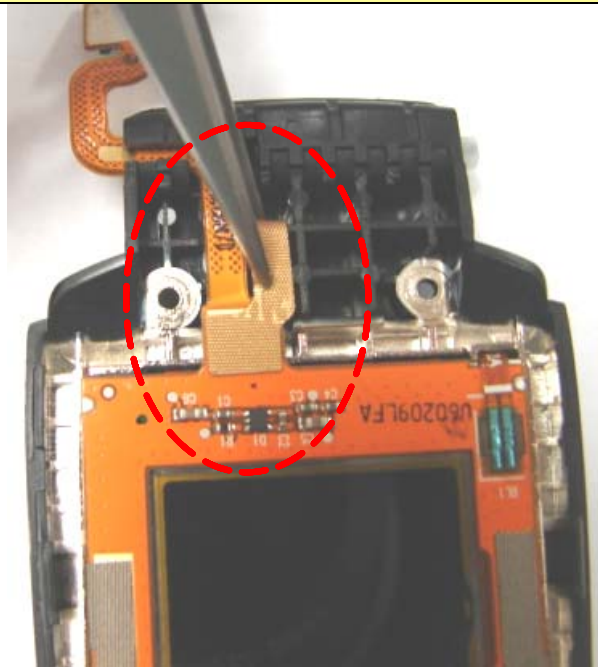

1) Sticking the EMI tape by using a pinset.

1) When we disjoint the Front, be care of body transformation.

5



1) Assembling Folder Lower like this picture.

1) Assembling Folder Lower like this picture.



1) Insert the screw and put on the screw cap.

1) Be care of scratch and molding damage.

7



1) Insert Folder hinge into Front.

1) Be care of scratch and molding damage.

8



1) Sticking the foreign object projection Tape by using a pinset.  
 2) Insert Keypad and Side Key.

1) Be care of scratch and molding damage.

9



1) Inter a PBA into the Front and assembling connector.

1) Be care of scratch and molding damage.

10



1) Folder Higher position assembling and after Lower position assembling.

1) Be care of scratch and molding damage.

11



1) Sticking a screw this four point at Rear.

1) Be care of scratch and molding damage.