



DUAL BAND Mobile Cellular Phone SGH-N400

SERVICE Manual

DUAL BAND MOBILE CELLULAR PHONE

CONTENTS



1. Exploded Views and Parts List

- 1-1 Main
- 1-2 Main Parts List
- 1-3 Travel Adapter
- 1-4 Cigar Light Adapter
- 1-5 Simple Hands Free Kit
- 1-6 Test Jig
- 1-7 Earphone
- 1-8 Data Kit
- 1-9 Desk Top Charger

2. PCB Diagrams & Schematic Diagrams

- 2-1-1 Main Top
- 2-1-2 Main Bottom
- 2-2-1 Logic Schematic
- 2-2-2 Power Schematic
- 2-2-3 RF Schematic

3. Electrical Parts List

- 3-1 Main Parts

4. Block Diagrams

- 4-1 Main Base Band
- 4-2 Main RF

5. Flow Chart of Troubleshooting

- 5-1 Power ON
- 5-2 Initial
- 5-3 Charging Part
- 5-4 SIM Part
- 5-5 Microphone Part
- 5-6 Speaker Part
- 5-7 Key Data Input
- 5-8 Alert Tone
- 5-9 Ring Indicator
- 5-10 Back Light
- 5-11 Auto Antenna Troubleshooting
- 5-12 RF Troubleshooting
- 5-13 Tx Troubleshooting
- 5-14 Rx Troubleshooting

1. Exploded Views and Parts List

1-1 Main

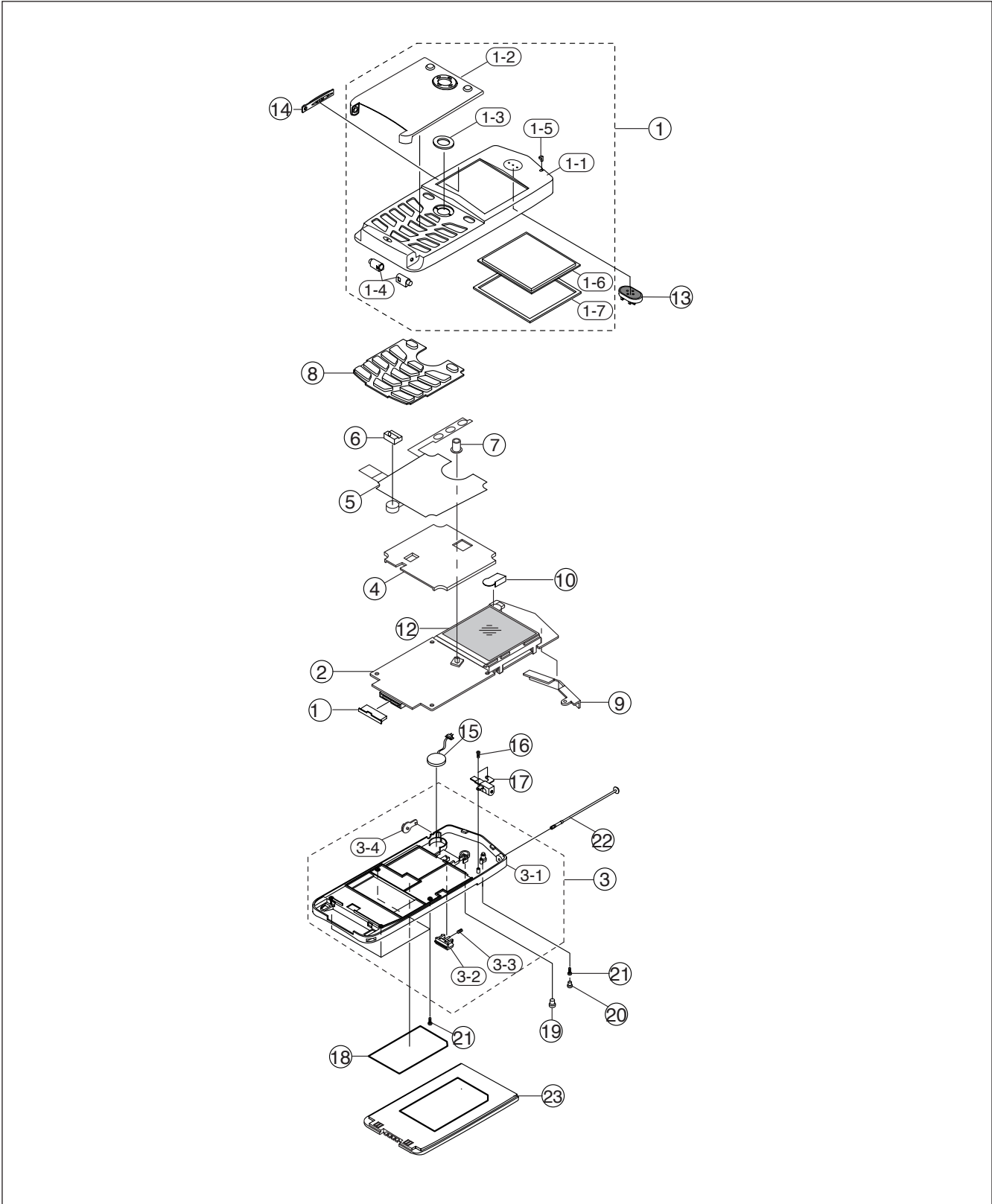

1-2 Main Parts List

NO		PART NAME	SEC CODE	Q'TY	REMARK
1		FRONT ASS'Y	GH75-00965A(EU)	1	SA
			GH75-01257A(AMN)		
			GH75-01256A(ATL)		
			GH75-01213A(TIM)		
			GH75-01290A(WIN)		
			GH75-01255A(XEC)		
	1	FRONT COVER	GH72-02155A	1	SNA
	2	FLIP ASS'Y	GH75-00967A(EU)	1	SA
			GH75-01254A(AMN)		
			GH75-01253A(ATL)		
			GH75-01212A(TIM)		
			GH75-01289A(WIN)		
			GH75-01252A(XEC)		
	3	NAVI-DUMMY-FRONT	GH72-02165A	1	SNA
	4	HINGE ASS'Y	GH75-00350A	1	SNA
	5	LED LENS	GH72-02161A	1	SNA
6	WINDOW-LCD	GH72-02163A	1	SNA	
7	SPONGE WINDOW	GH74-01104A	1	SNA	
2	MAIN-PBA	GH92-00940A	1	SA	
3		REAR ASS'Y	GH75-00966A	1	SA
	1	REAR COVER	GH72-02421A	1	SNA
	2	LOCKER MAIN	GH72-02422A	1	SNA
	3	SPRING LOCKER	GH61-00009A	1	SNA
	4	EARJACK RUBBER	GH73-00608A	1	SNA

4	SHIELD COVER	GH71-00466A	1	SA
5	KEY-PCB	GH59-00172A	1	SA
6	MIC-RUBBER	GH73-00609A	1	SA
7	NAVIGATION KEY	GH72-02162A	1	SA
8	KEY-MAIN	GH73-00603A	1	SA
9	INTENNA GUIDE	GH75-01117A	1	SA
10	BUZZER RUBBER	GH73-00602A	1	SA
11	COVER CONN.	GH73-00758C	1	SA
12	LCD ASSY	GH07-00064A	1	SA
13	SPEAKER	3001-001231	1	SA
14	VOL-KEY	GH73-00605A	1	SA
15	MOTOR	GH31-00028A	1	SA
16	SCREW	6001-000464	2	SA
17	INTENNA-MODULE	GH75-00802A	1	SA
18	MAIN-LABEL	GH68-02050C	1	SA
19	MOBILE CAP	GH73-00606A	1	SA
20	SCREW CAP	GH73-00607A	1	SA
21	SCREW	6001-000883	5	SA
22	WHIP ANT	GH42-00104A	1	SA
23	BATT. STD	GH43-00309A	1	SA

4	SHIELD COVER	GH71-00466A	1	SA
5	KEY-PCB	GH59-00172A	1	SA
6	MIC-RUBBER	GH73-00609A	1	SA
7	NAVIGATION KEY	GH72-02162A	1	SA
8	KEY-MAIN	GH73-00603A	1	SA
9	INTENNA GUIDE	GH72-02164A	1	SA
10	BUZZER RUBBER	GH73-00602A	1	SA
11	COVER CONN.	GH73-00758C	1	SA
12	LCD ASS'Y	GH07-00064A	1	SA
13	SPEAKER	3001-001231	1	SA
14	VOL-KEY	GH73-00605A	1	SA
15	MOTOR	GH31-00028A	1	SA
16	SCREW	6001-000464	2	SA
17	INTENNA-MODULE	GH75-01117A	1	SA
18	MAIN-LABEL	GH68-02050C	1	SA
19	MOBILE CAP	GH73-00606A	1	SA
20	SCREW CAP	GH73-00607A	1	SA
21	SCREW	6001-000883	5	SA
22	WHIP ANT	GH42-00104A	1	SA
23	BATT. STD	GH43-00309A	1	SA

1-3 Travel Adapter

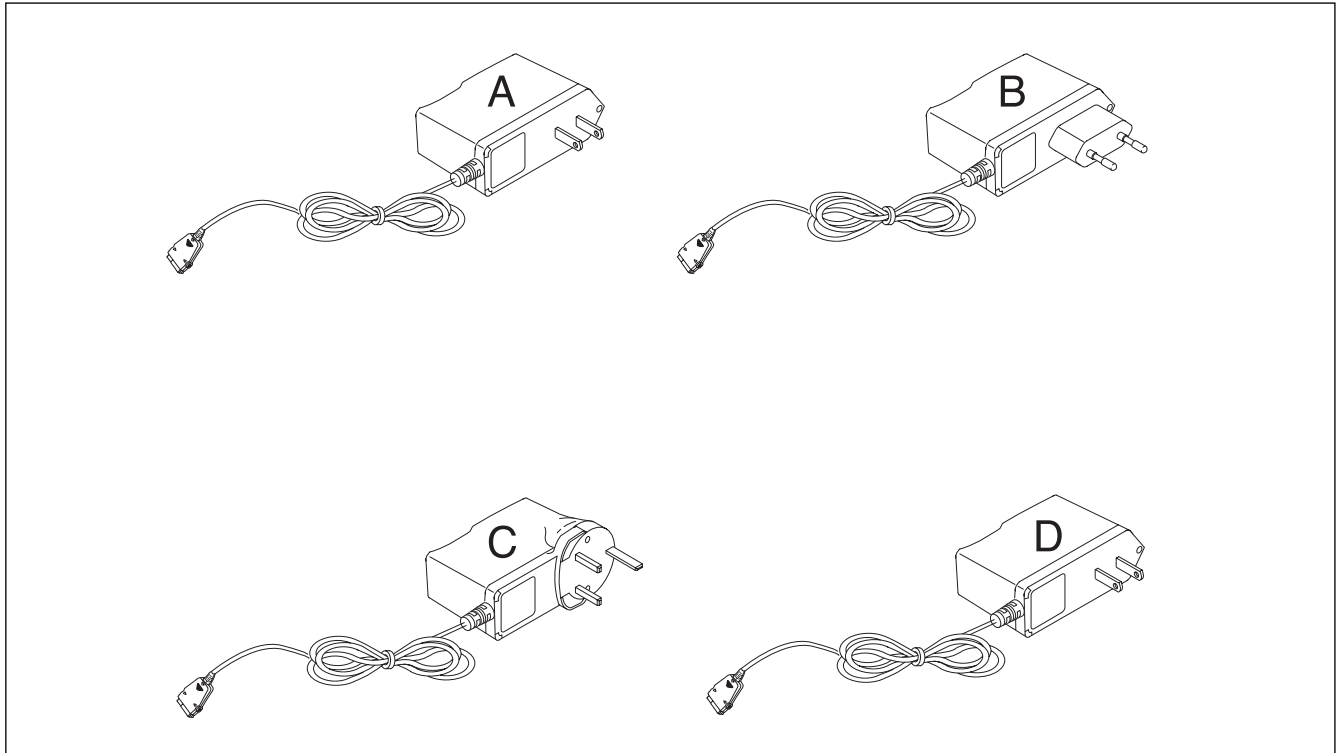

TYPE	SEC CODE	REMARK
A	GH44-00171A	CHINA
B	GH44-00184A	EUROPE
C	GH44-00171C	UNITED KINGDOM
D	GH44-00171E	JAPAN

1-4 Cigar Light Adapter

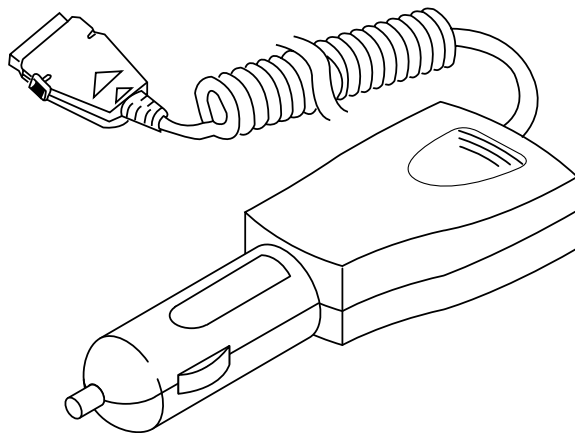

Cigar Light Adapter

GH44-00199A

1-5 Simple Hands Free Kit

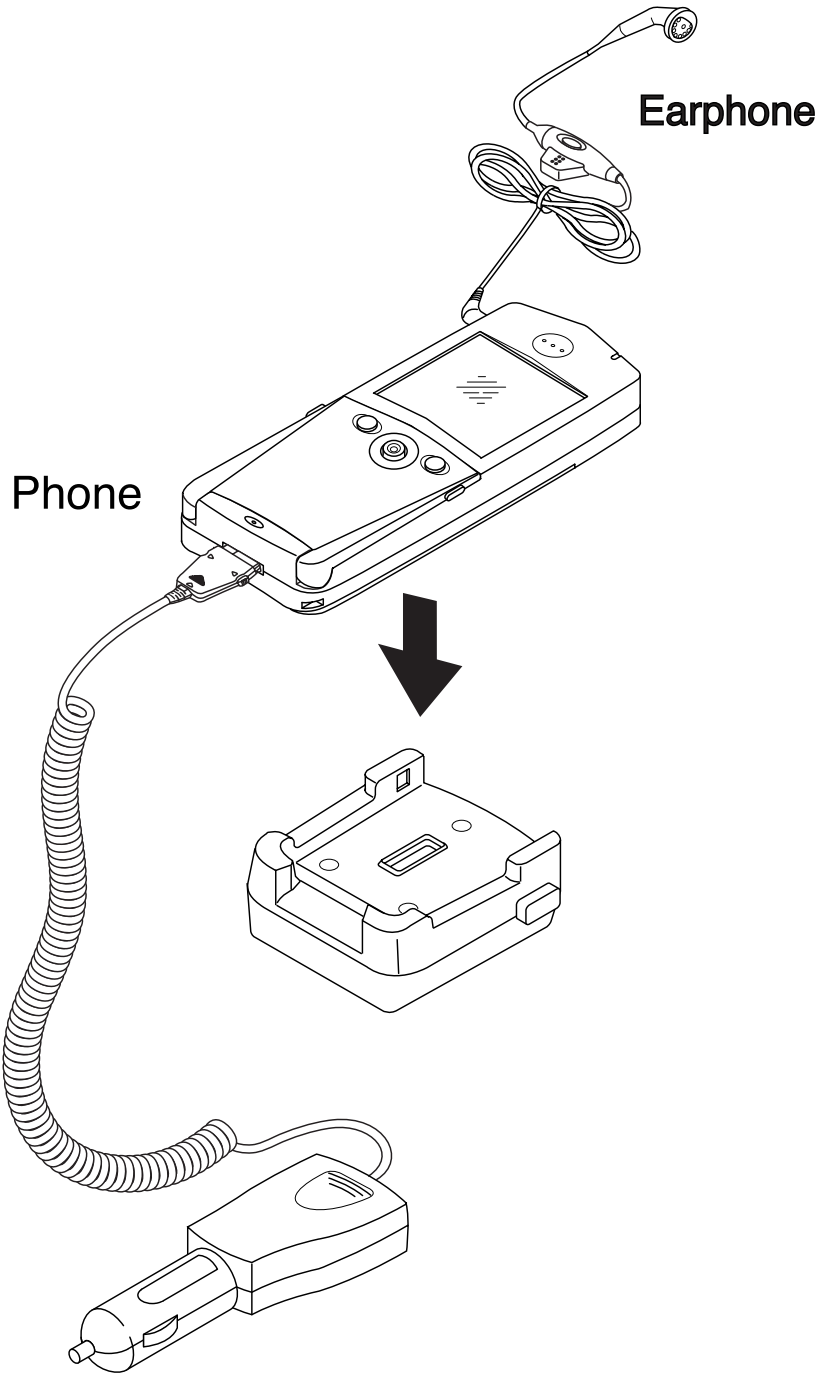

Simple Hands Free kit	CKT046EBE(Model)
SEC CODE	GH96-00941A

1-6 Test Jig

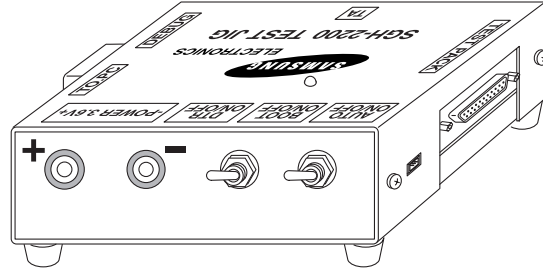

TEST JIG BOX

GH80-10508A

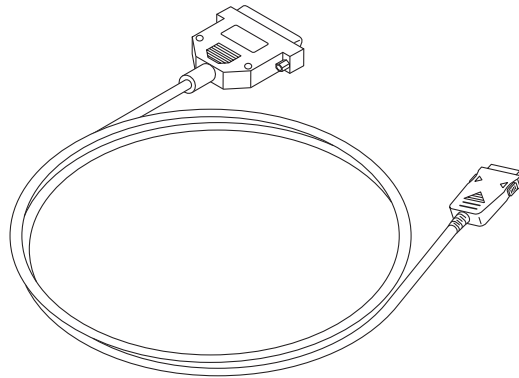

TEST JIG CABLE

GH39-00079A

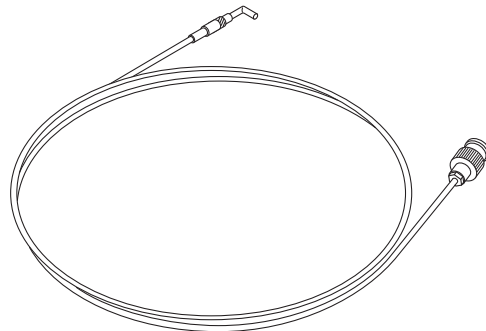

TEST RF CABLE

GH39-00090A

1-7 Earphone

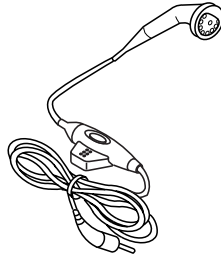

EARPHONE

GH96-00830A

1-8 Data Kit

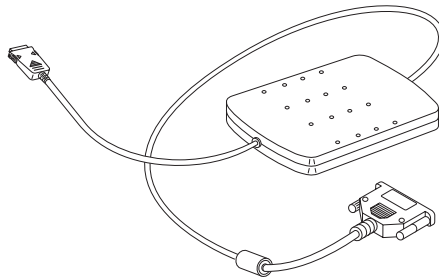

DATA KIT

GH39-00078A

1-9 Desk Top Charger

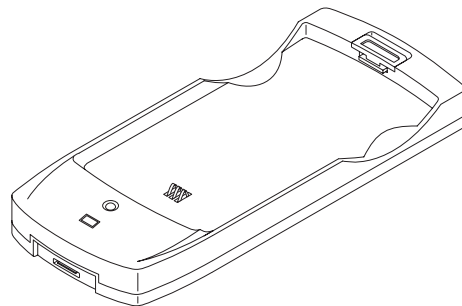

DESK TOP CHARGER

GH44-00232A

2. PCB Diagrams & Schematic Diagrams

2-1-1 Main Top

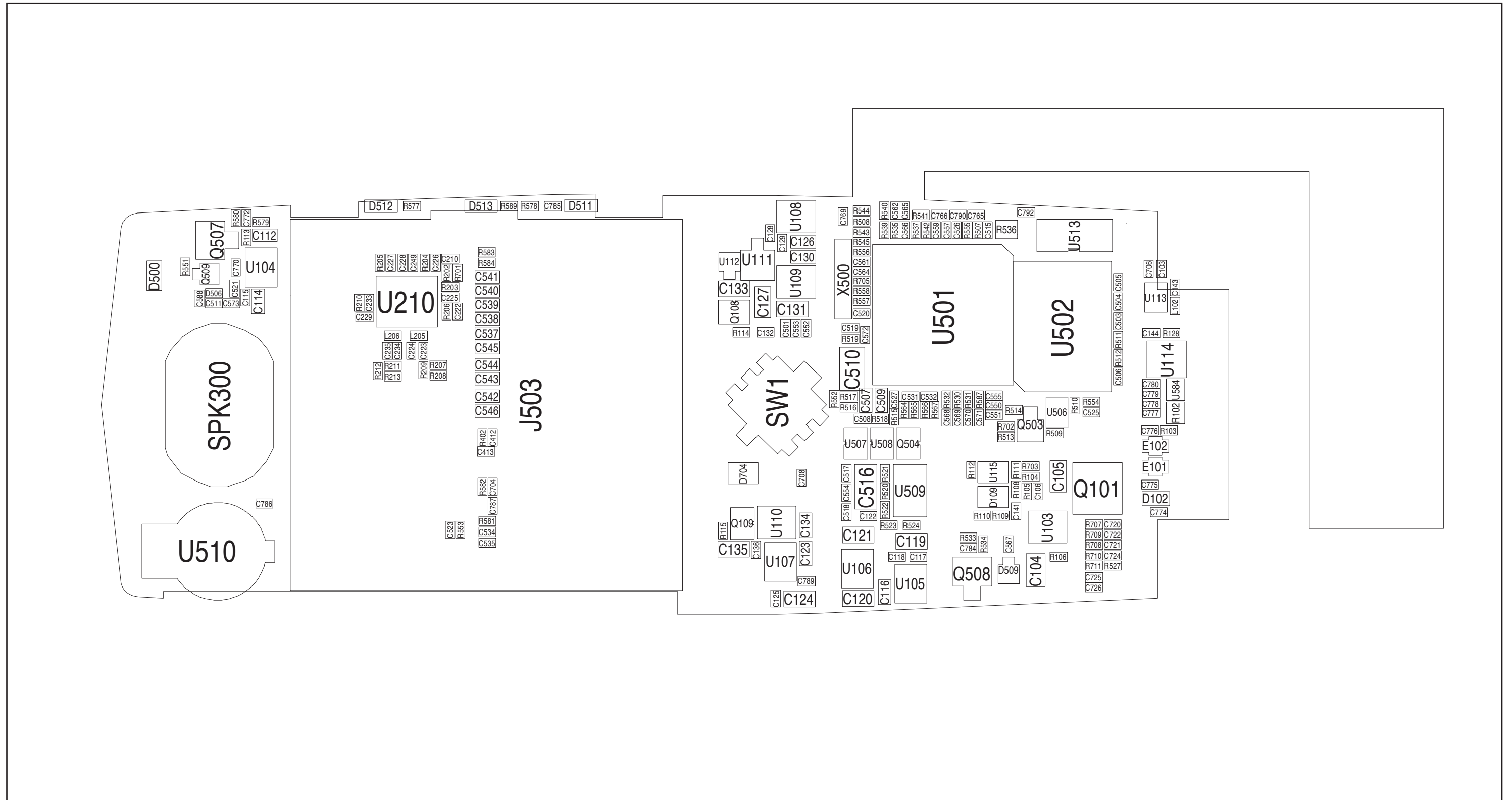

2-1-2 Main Bottom

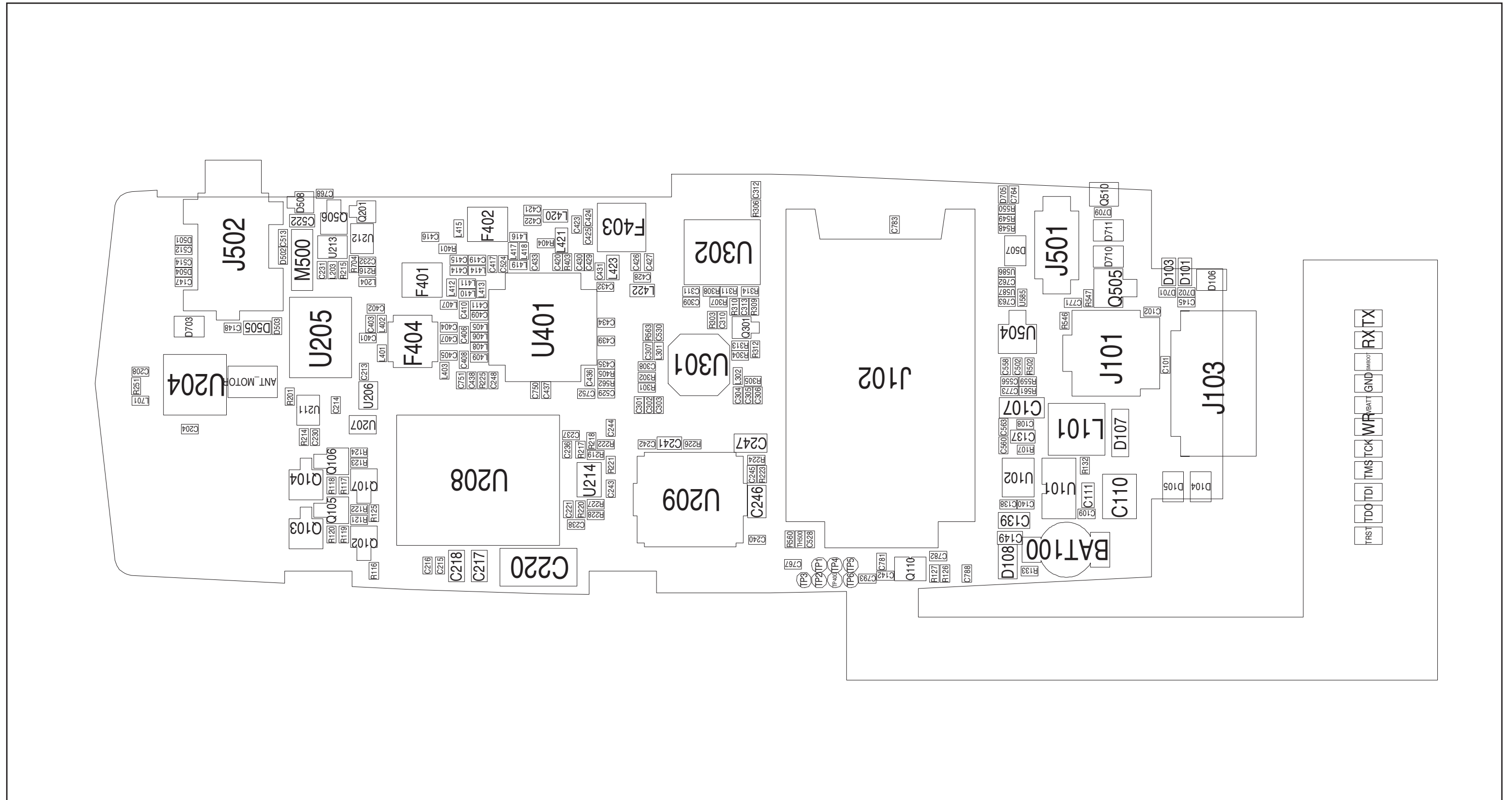

2-2-1 Logic Schematic

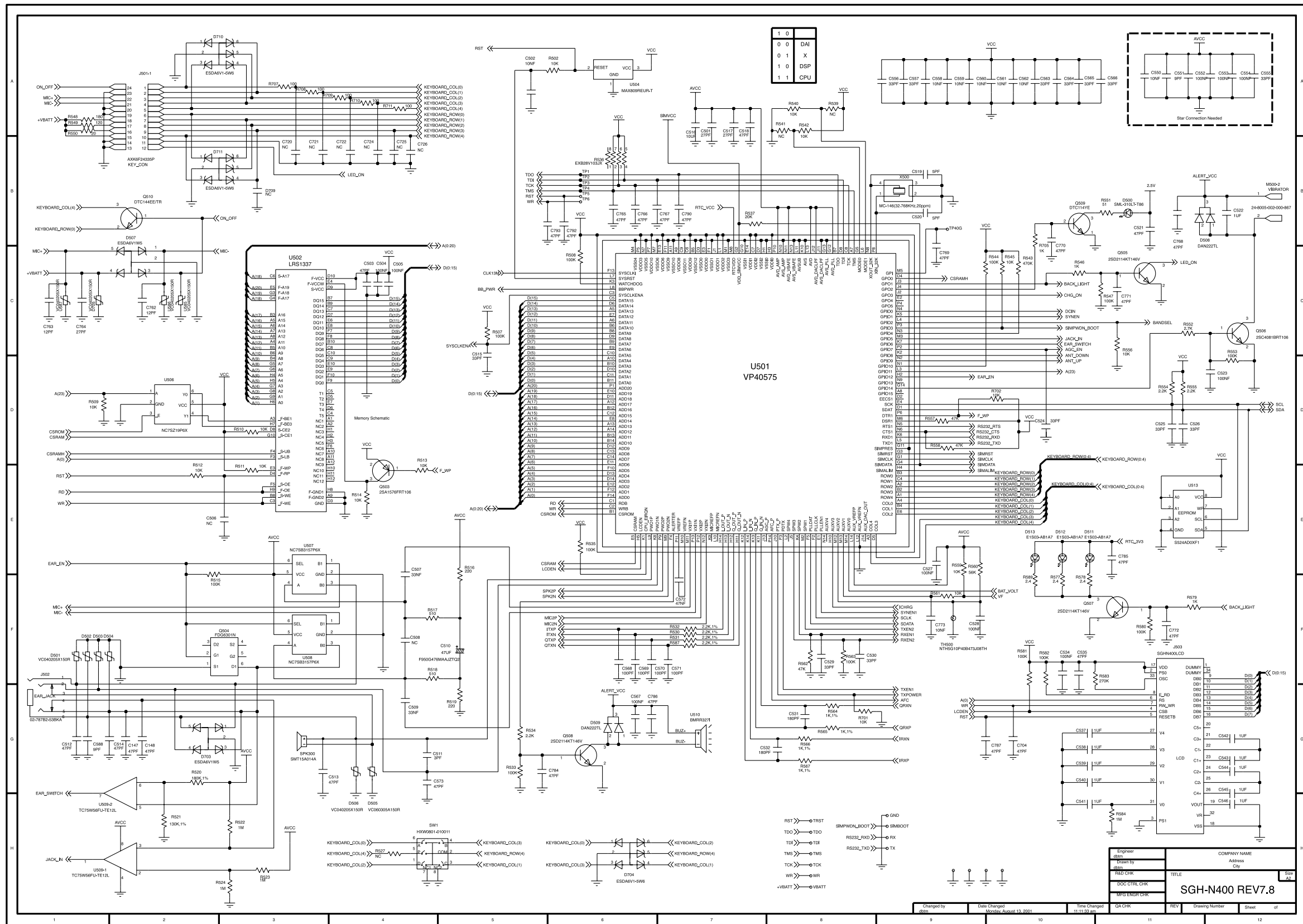

2-2-2 Power Schematic

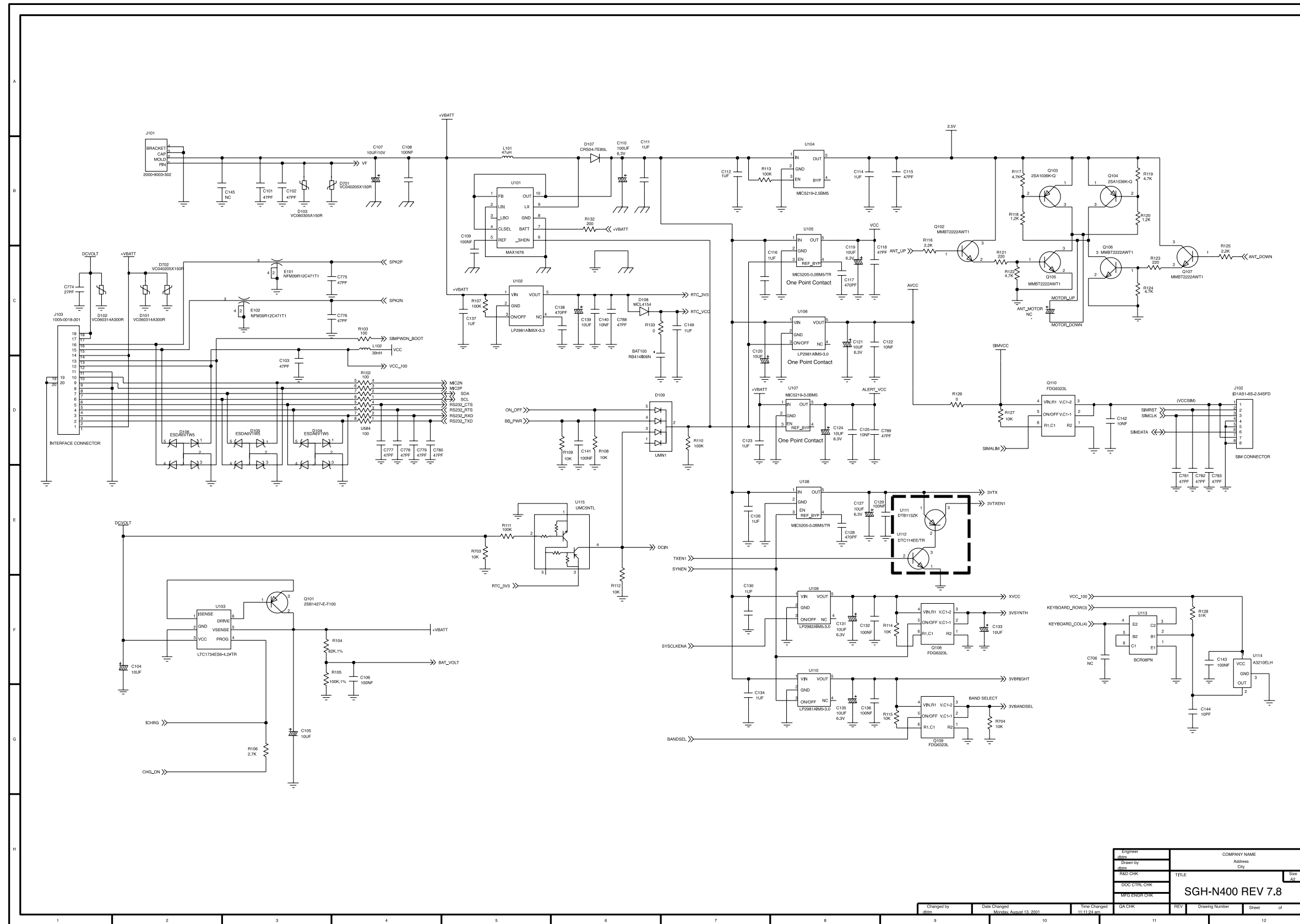

2-2-3 RF Schematic

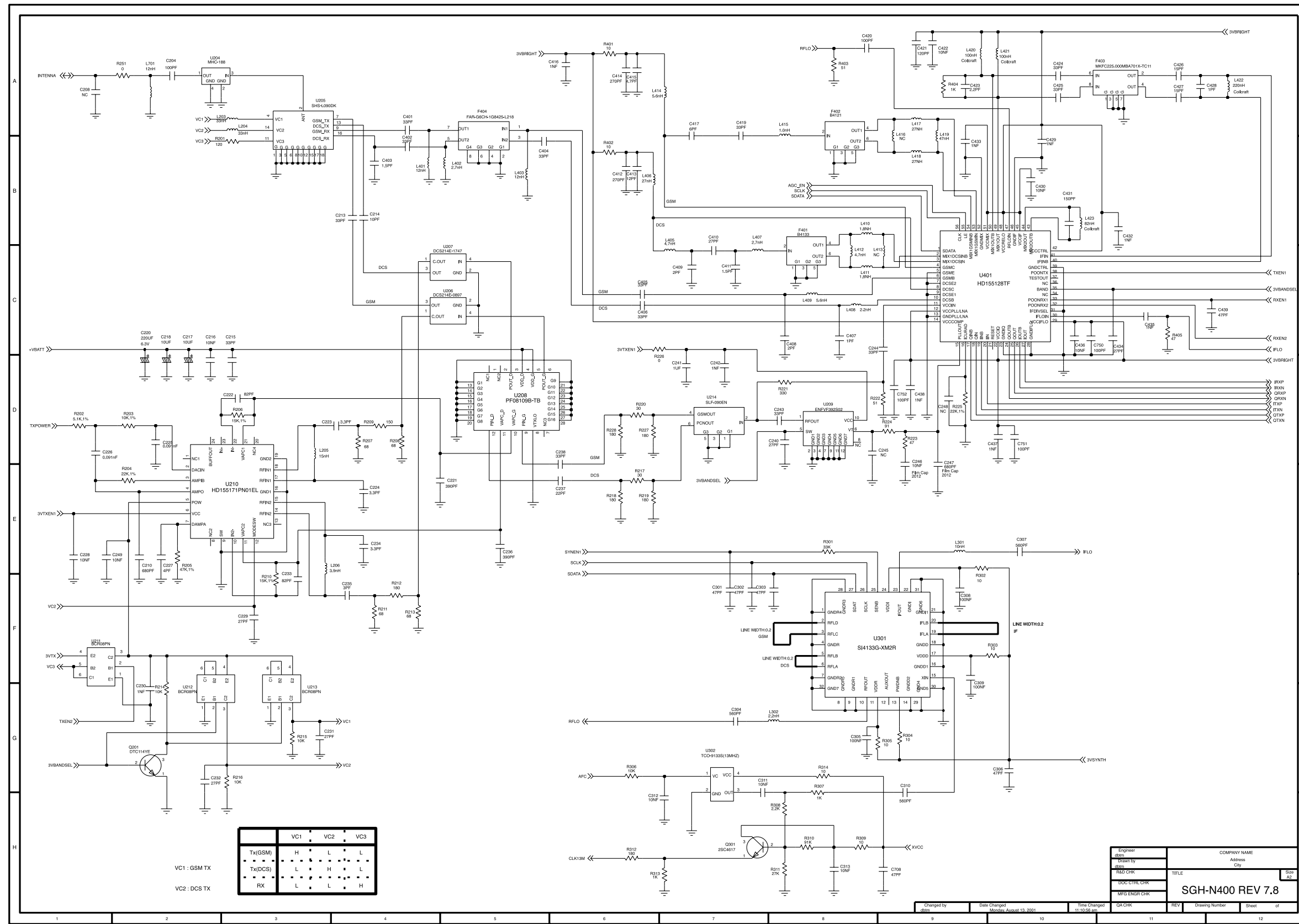

	VC1	VC2	VC3
Tx(GSM)	H	L	L
Tx(DCS)	L	H	L
RX	L	L	H

VC1 : GSM TX
VC2 : DCS TX

Engineer	COMPANY NAME
Drawn by	Address
Checked by	City
DOO: DTR, LDR	TITLE
MFG ENGR CKR	SGH-N400 REV 7.8
Changed by	Date Changed
Time Changed	QA CKR
REV	REV
Drawing Number	Sheet
	of

3. Electrical Parts List

3-1 Main Parts

ITEM NUMBER	COMPANY PART. NO	GEOMETRY	COUNT	DESCRIPTION	REFERENCE
1	0401-001033	R2412_DIO	1	MCL4154	D108
2	0402-001331	R3516_DIO	1	CRS04-TE85L	D107
3	0406-001083	sop5_w210_P0.65	5	ESDA6V1W5	D104 D105 D106 D507 D703
4	0406-001104	sot323-6L	2	ESDA6V1-5W6	D704 D711
5	0407-001002	EMD_3	2	DAN222TL	D508 D509
6	0407-001007	Csop5_w210_P0.65	1	UMN1	D109
7	0501-000162	sot_323a	1	2SA1576FRT106	Q503
8	0501-000218	sot_323a	1	2SC4081BRT106	Q506
9	0501-000225	EMD_3	1	2SC4617	Q301
10	0501-000729	sot_23_hvm14s	2	2SA1036K-Q	Q103 Q104
11	0501-002011	sot_23_R	3	2SD2114KT146V	Q505 Q507 Q508
12	0501-002202	sot_323a	4	MMBT2222AWT1	Q102 Q105 Q106 Q107
13	0501-002346	sot_89_2	1	2SB1427-E-T100	Q101
14	0504-000167	EMD_3	1	DTC114EE/TR	U112
15	0504-000168	EM3_a	1	DTC144EE/TR	Q510
16	0504-001012	EMD_3	2	DTC114YE	Q201 Q509
17	0504-001021	sot_23_hvm14s	1	DTB113ZK	U111
18	0504-001060	sot_363	4	BCR08PN	U113 U211 U212 U213
19	0505-001332	Csop6_w190	1	FDG6301N	Q504
20	0505-001423	Csop6_w190	3	FDG6323L	Q108 Q109 Q110
21	0506-001004	Csop5_w210_P0.65	1	UMC5NTL	U115
22	0601-001226	SR1608_LED_1226	1	SML-310LT-T86	D500
23	0601-001542	R1608_LED_1	3	E1S03-AB1A7	D511 D512 D513
24	0801-002540	sc-88	1	NC7SZ19P6X	U506
25	1001-001155	Csop6_w190	2	NC7SB3157P6X	U507 U508
26	1009-001006	sc-74_v4	1	A3210ELH	U114
27	1103-001185	Csop8_w560	1	S524AD0XF1	U513
28	1106-001301	bga72_w1100h800_L_v2	1	LRS1337	U502
29	1201-001583	sm_POWAMP_PFO8109	1	PF08109B-TB	U208
30	1202-001022	Csop8_w340_L06	1	TC75W56FU-TE12L	U509
31	1203-001204	sot23-5M	1	LP2981AIM5X-3.3	U102
32	1203-001285	sot23-5M	2	MIC5205-3.0BM5/TR	U105, U108
33	1203-001454	sot23-5M	2	LP2981AIM5X-3.0	U106 U110
34	1203-001511	sot_23_R	1	MAX809REUR-T	U504
35	1203-001720	sot23-5M	1	MIC5219-3.0BM5	U107
36	1203-001701	sot23-5M	1	LP2982AIM5X-3.0	U109
37	1203-001702	Csop10_w435_L05	1	MAX1676EUB-T	U101

ITEM NUMBER	COMPANY PART. NO	GEOMETRY	COUNT	DESCRIPTION	REFERENCE
38	1203-002113	sot23-5M	1	MIC5219-2.5BM5	U104
39	1203-002127	sot23-6M	1	LTC1734ES6-4.2#TR	U103
40	1203-002168	sot23-5M	1	LP3985IM5X-3.0	U105
41	1205-001881	bga180_w1200h1200_L_v2	1	VP40575	U501
42	1205-001935	Cqfp56_w870h870_L045	1	HD155128TF	U401
43	1209-001292	QFN24_w520h420_v2	1	HD155171PN01EL	U210
44	1209-001337	sm_MLP28_w500h500-1	1	SI4133G-XM2R	U301
45	1404-001221	ALL1005_RES	1	NTH5G10P40B473J08TH	TH500
46	1405-001018	R1608_CAP	2	VC060314A300R	D101 D102
47	1405-001019	R1608_CAP	2	VC060305A150R	D103 D505
48	1405-001082	ALL1005_RES	11	VC040205X150R	D501 D502 D503 D504 D506 D701 D702 D705 U585 U586 U587
49	2007-000138	ALL1005_RES	6	100,5%	R103 R707 R708 R709 R710 R711
50	2007-000139	ALL1005_RES	4	220,5%	R121 R123 R516 R519
51	2007-000140	ALL1005_RES	6	1K,5%	R307 R313 R404 R546 R579 R705
52	2007-000141	ALL1005_RES	6	2.2K,5%	R116 R125 R308 R534 R554 R555
53	2007-000142	ALL1005_RES	1	2.7K,5%	R552
54	2007-000143	ALL1005_RES	4	4.7K,5%	R117 R119 R122 R124
55	2007-000148	ALL1005_RES	27	10K,5%	R108 R109 R112 R114 R115 R127 R214 R215 R216 R306 R502 R509 R510 R511 R512 R513 R514 R540 R542 R545 R556 R559 R561 R701 R702 R703 R704
56	2007-000152	ALL1005_RES	1	20K,5%	R537
57	2007-000155	ALL1005_RES	1	27K,5%	R311
58	2007-000157	ALL1005_RES	3	47K,5%	R557 R558 R562
59	2007-000159	ALL1005_RES	1	56K,5%	R560
60	2007-000162	ALL1005_RES	16	100K,5%	R107 R110 R111 R113 R507 R508 R515 R533 R535 R544 R547 R553 R563 R580 R581 R582
61	2007-000168	ALL1005_RES	1	470K,5%	R543
62	2007-000170	ALL1005_RES	4	1M,5%	R522 R523 R524 R584
63	2007-000172	ALL1005_RES	8	10,5%	R302 R303 R304 R305 R309 R314 R401 R402
64	2007-000174	ALL1005_RES	2	47,5%	R223 R405

ITEM NUMBER	COMPANY PART. NO	GEOMETRY	COUNT	DESCRIPTION	REFERENCE
65	2007-000636	ALL1005_RES	1	270K,5%	R583
66	2007-000775	ALL1005_RES	1	33K,5%	R301
67	2007-001244	ALL1005_RES	1	91K,5%	R310
68	2007-001291	ALL1005_RES	2	30,5%	R217 R220
69	2007-001298	ALL1005_RES	3	51,5%	R222 R403 R551
70	2007-001301	ALL1005_RES	4	68,5%	R207 R208 R211 R213
71	2007-001305	ALL1005_RES	2	120,5%	R201 R549
72	2007-001306	ALL1005_RES	1	150,5%	R209
73	2007-001307	ALL1005_RES	7	180,5%	R212 R218 R219 R227 R228 R312 R548
74	2007-001308	ALL1005_RES	1	200,5%	R132
75	2007-001313	ALL1005_RES	1	330,5%	R221
76	2007-001319	ALL1005_RES	2	1.2K,5%	R118 R120
77	2007-002796	ALL1005_RES	2	510,5%	R517 R518
78	2007-003010	ALL1005_RES	1	20,5%	R550
79	2007-003030	ALL1005_RES	1	91,5%	R224
80	2007-007014	ALL1005_RES	1	51K,5%	R128
81	2007-007107	ALL1005_RES	1	100K,1%	R105
82	2007-007132	ALL1005_RES	2	15K,1%	R206 R210
83	2007-007139	ALL1005_RES	1	47K,1%	R205
84	2007-007142	ALL1005_RES	1	10K,1%	R203
85	2007-007200	ALL1005_RES	3	2.4,5%	R577 R578 R589
86	2007-007311	ALL1005_RES	2	22K,1%	R204 R225
87	2007-007317	ALL1005_RES	4	2.2K,1%	R530 R531 R532 R587
88	2007-007318	ALL1005_RES	4	1K,1%	R564 R565 R566 R567
89	2007-007480	ALL1005_RES	1	130K,1%	R521
90	2007-007590	ALL1005_RES	1	82K,1%	R104
91	2007-007698	ALL1005_RES	1	5.1K,1%	R202
92	2007-007771	ALL1005_RES	4	0,5%	R126 R133 R226 R251
93	2007-007981	ALL1005_RES	1	180K,1%	R520
94	2007-008117	ALL1005_RES	1	2.7K, 1%	R106
95	2011-001344	R2010_RES_AR_1	2	EXB28V101JX	R102 U584
96	2011-001345	R2010_RES_AR_1	1	EXB28V103JX	R536
97	2203-000233	ALL1005_CAP	9	C101J,100PF,50V	C204 C420 C568 C569 C570 C571 C750 C751 C752
98	2203-000254	ALL1005_CAP	21	C103K,10NF,16V	C122 C125 C140 C142 C216 C228 C249 C311 C312 C313 C422 C430 C436 C502 C550 C558 C559 C560 C561 C562 C773
99	2203-000278	ALL1005_CAP	2	C100D,10PF,50V	C144 C214
100	2203-000311	ALL1005_CAP	1	C121J,120PF,50V	C421

ITEM NUMBER	COMPANY PART. NO	GEOMETRY	COUNT	DESCRIPTION	REFERENCE
101	2203-000330	ALL1005_CAP	3	C120J,12PF,50V	C413 C762 C763
102	2203-000359	ALL1005_CAP	1	C151J,150PF,50V	C431
103	2203-000386	ALL1005_CAP	2	C150J,15PF,50V	C426 C427
104	2203-000438	ALL1005_CAP	9	C102K,1NF,50V	C230 C242 C416 C429 C432 C433 C435 C437 C438
105	2203-000628	ALL1005_CAP	1	C220J,22PF,50V	C237
106	2203-000654	ALL1005_CAP	2	C271K,270PF,50V	C412 C414
107	2203-000679	ALL1005_CAP	10	C270J,27PF,50V	C229 C231 C232 C240 C410 C434 C501 C517 C764 C774
108	2203-000696	ALL1005_CAP	2	C020C,2PF,50V	C408 C409
109	2203-000800	SR1608_CAP	2	C333K,33NF,25V	C507 C509
110	2203-000812	ALL1005_CAP	26	C330J,33PF,50V	C213 C215 C238 C243 C244 C401 C402 C404 C405 C406 C419 C424 C425 C515 C524 C525 C526 C529 C530 C555 C556 C557 C563 C564 C565 C566
111	2203-000836	ALL1005_CAP	2	C391K,390PF,50V	C221 C236
112	2203-000870	ALL1005_CAP	1	C030C,3PF,50V	C511
113	2203-000940	ALL1005_CAP	3	C471K,470PF,50V	C117 C128 C138
114	2203-000995	ALL1005_CAP	48	C470J,47PF,50V	C101 C102 C103 C115 C118 C147 C148 C301 C302 C303 C306 C439 C503 C512 C513 C514 C518 C521 C535 C573 C704 C708 C765 C766 C767 C768 C769 C770 C771 C772 C775 C776 C777 C778 C779 C780 C781 C782 C783 C784 C785 C786 C787 C788 C789 C790 C792 C793
115	2203-001017	ALL1005_CAP	1	C040C,4PF,50V	C227
116	2203-001124	ALL1005_CAP	1	C681K,680PF,50V	C210
117	2203-001239	ALL1005_CAP	2	C820J,82PF,50V	C222 C233
118	2203-001437	ALL1005_CAP	2	C050C,5PF,50V	C519 C520
119	2203-002525	ALL1005_CAP	3	C561K,560PF,50V	C304 C307 C310
120	2203-003054	ALL1005_CAP	2	C090C,9PF,50V	C551 C588
121	2203-005054	ALL1005_CAP	1	C4R7C,4.7PF,50V	C415
122	2203-005061	ALL1005_CAP	21	C104Z,100NF,16V	C106 C108 C109 C129 C132 C136 C141 C143 C305 C308 C309 C504 C505 C523 C527 C528 C534 C552 C553 C554 C567

ITEM NUMBER	COMPANY PART. NO	GEOMETRY	COUNT	DESCRIPTION	REFERENCE
123	2203-005065	SR1608_CAP	22	C105Z,1UF,10V	C111 C112 C114 C116 C123 C126 C130 C134 C137 C149 C241 C522 C537 C538 C539 C540 C541 C542 C543 C544 C545 C546
124	2203-005281	ALL1005_CAP	2	C1R5B,1.5PF,50V	C403 C411
125	2203-005288	ALL1005_CAP	2	C010B,1PF,50V	C407 C428
126	2203-005382	ALL1005_CAP	1	C060B,6PF,50V	C417
127	2203-005443	ALL1005_CAP	3	C3R3B,3.3PF,50V	C223 C224 C234
128	2203-005444	ALL1005_CAP	1	C030B,3PF,50V	C235
129	2203-005481	ALL1005_CAP	1	C473K,47NF,10V	C572
130	2203-005503	ALL1005_CAP	2	C1801J,180PF,25V	C531 C532
131	2203-005552	ALL1005_CAP	1	C2R2B,2.2PF,50V	C423
132	2203-005562	R3216_CAP_N	2	C106Z,10UF,10V	C516
133	2203-005707	ALL1005_CAP	2	0.091NF,50V	C225 C226
134	2301-001230	SR2012_CAP_N	1	10NF,16V	C246
135	2301-001231	SR2012_CAP_N	1	680PF,50V	C247
136	2404-001020	R3216_TAN	1	10UF/10V	C107
137	2404-001105	R2012_TAN_N	12	10UF/6.3V	C105 C119 C120 C121 C124 C127 C131 C133 C135 C139 C217 C218
138	2404-001162	tantal_test20_v2	1	F950G476MAAJZTQ2	C510
139	2404-001210	R7125_TAN_v2	1	220UF/6.3V	C220
140	2404-001239	SR3327_TAN_v2	1	100UF/6.3V	C110
141	2404-001268	SR	1	10UF/10V	C104
142	2703-001409	ALL1005_IND	3	LL1005-F12NK	L401 L403 L701
143	2703-001513	SR1608_IND	2	0603CS-R10XJBC	L420 L421
144	2703-001685	SR1608_IND	1	0603CS-82NXJBC	L423
145	2703-001723	ALL1005_IND	2	LL1005-FH33NJ	L203 L204
146	2703-001726	ALL1005_IND	2	LL1005-FH27NJ	L417 L418
147	2703-001729	ALL1005_IND	2	LL1005-FH1N8S	L410 L411
148	2703-001730	ALL1005_IND	1	LL1005-FH15NJ	L205
149	2703-001737	ALL1005_IND	1	HK1005-2N7S-T	L407
150	2703-001747	ALL1005_IND	2	LL1005-FH4N7S	L405 L412
151	2703-001748	ALL1005_IND	2	LL1005-FH5N6S	L409 L414
152	2703-001749	ALL1005_IND	1	LL1005-FH1N0S	L415
153	2703-001750	ALL1005_IND	2	LL1005-FH2N2S	L302 L408
154	2703-001751	ALL1005_IND	1	LL1005-FH3N9S	L206
155	2703-001752	ALL1005_IND	1	LL1005-FH39NJ	L102
156	2703-001913	SR1608_IND	1	0603CS-R22XJBC	L422
157	2703-001943	ALL1005_IND	1	HK1005-10NJ-T	L301
158	2703-001944	ALL1005_IND	1	HK1005-27NK-T	L406

ITEM NUMBER	COMPANY PART. NO	GEOMETRY	COUNT	DESCRIPTION	REFERENCE
159	2703-002025	R4848_IND	1	BTC-0309-470M	L101
160	2703-002027	ALL1005_IND	1	LQG10A2N7S00	L402
161	2703-002155	ALL1005_IND	1	LL1005-FH47NJ	L419
162	2801-003856	sm_osc4_w620h085	1	MC-146(32.768KHz,20ppm)	X500
163	2806-001225	sm_osc12_w980h800_v2	1	ENFVF392S02	U209
164	2809-001255	sm_osc4_w508h420_A	1	TCO-9133S(13MHz)	U302
165	2901-001116	sm_filt4_EMI-1	2	NFM39R12C471T1	E101 E102
166	2903-001266	sm_filt_8_w380h380_A	1	MKFC225.000MBA701X-TC11	F403
167	2904-001226	sm_filt_6_f6ce_1	1	B4121	F402
168	2904-001228	sm_filt_6_f6ce_1	1	B4133	F401
169	2904-001235	sm_filt_8_w280h300_v2	1	FAR-G6CH-1G8425-L218	F404
170	2909-001144	sm_module16_w670h500_v2	1	SHS-L090DK	U205
171	3002-001116	sm_buz2_w850_v2	1	BMRR327I	U510
172	3403-001125	sm_switch8_w650h650	1	HXW0801-010011	SW1
173	3705-001226	sm_switch4_w500h500_v2	1	MHC-188	U204
174	3709-001177	sm_con8_w2860h1740_v2	1	ID1AS1-6S-2.54SFD	J102
175	3710-001105	sm_con2_w438	1	24-8005-002-000-867, VIBRATOR	M500
176	3710-001611	sm_con20_w1340h700_A_v3	1	1005-0018-301	J103
177	3711-004234	sm_con24_w560h290_1	1	AXK6F24335P	J501
178	3711-004758	sm_con3_TACT	1	2000-9003-302	J101
179	3722-001380	sm_jack6_53BKA_v3	1	02-787B2-53BKA	J502
180	4302-001119	sm_bat2_w750_v2	1	ML414R-TT30	BAT100
181	4709-001213	DCS214E-2012	1	DCS214E-1747	U207
182	4709-001214	DCS214E-2012	1	DCS214E-0897	U206
183	4709-001217	sm_filt_6_slf	1	SLF-090EN	U214
184	911-rfopen1005	ALL1005_RES	3	NC	R527 R539 R541
185	915-rfopen1005	ALL1005_CAP	8	NC	C105 C145 C208 C245 C248 C506 C508 D709
186	IND-open1005	ALL1005_IND	1	NC	L413
187	TESTPOINT-39	TP39	7	TP	TP1 TP2 TP3 TP4 TP5 TP6 TP40G
188	TESTPOINT-79	TP79	4	TP	V1 V2 V3 V4
189	TESTPOINT-p	TP59x98 59x98	11	TP	GND RX SIMBOOT TCK TDI TDO TMS TRST TX VBATT WR
190	khfr-SGHN400	sm_lcd34_SGHN400	1	SGHN400LCD	J503 LCD
191	3001-001231	sm_spk2_w1500h1000 _v3	1	SMT15A014A	SPK300
192	khfr-open	R3528_TAN	1	NC, VIBRATOR	ANT_MOTOR
-10UF/10V					
190	khfr-open1005 _IND	ALL1005_IND	1	NC	L416

4. Block Diagrams

4-1 Main Base Band

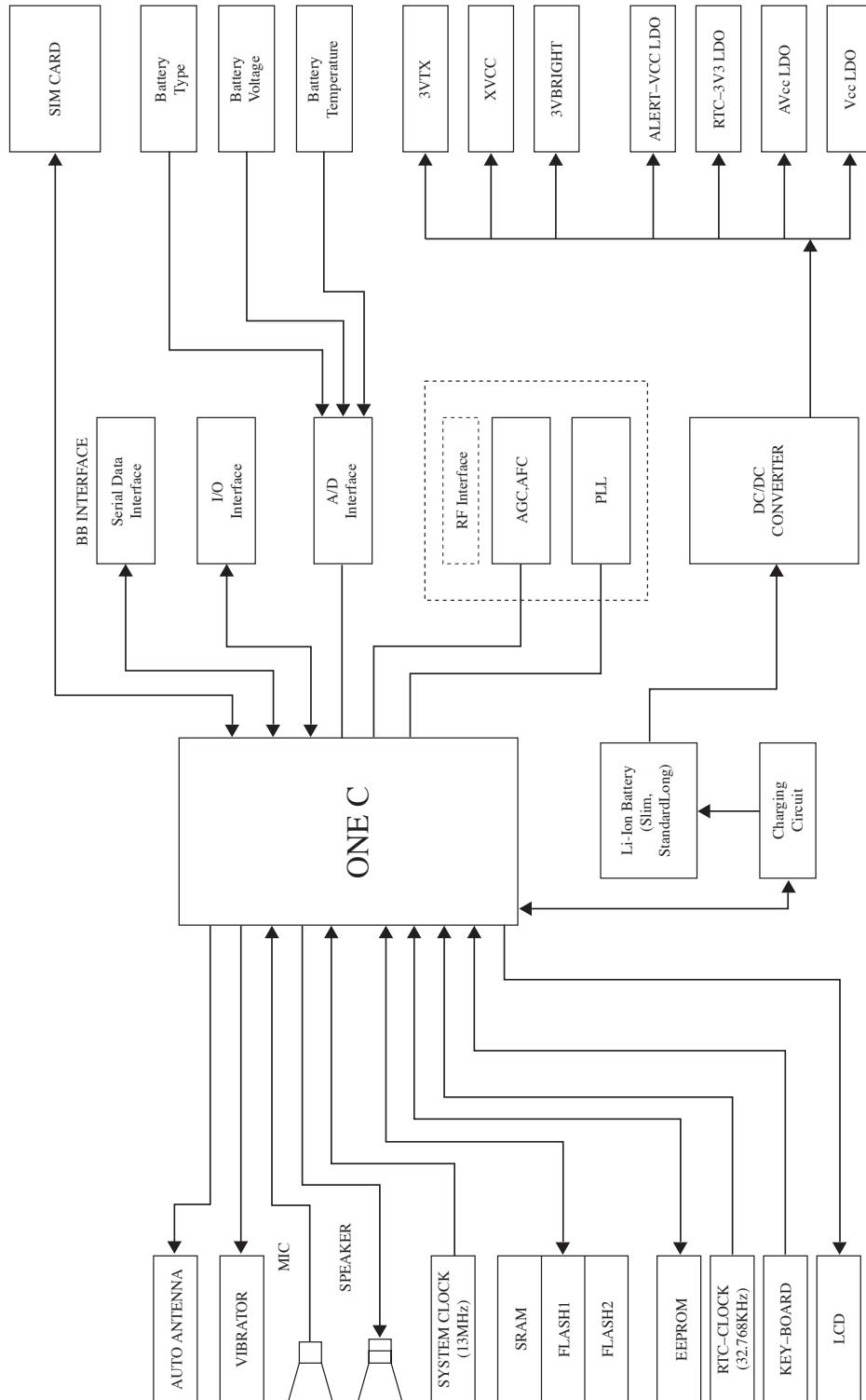

5. Flow Chart of Troubleshooting

5-1 Power ON

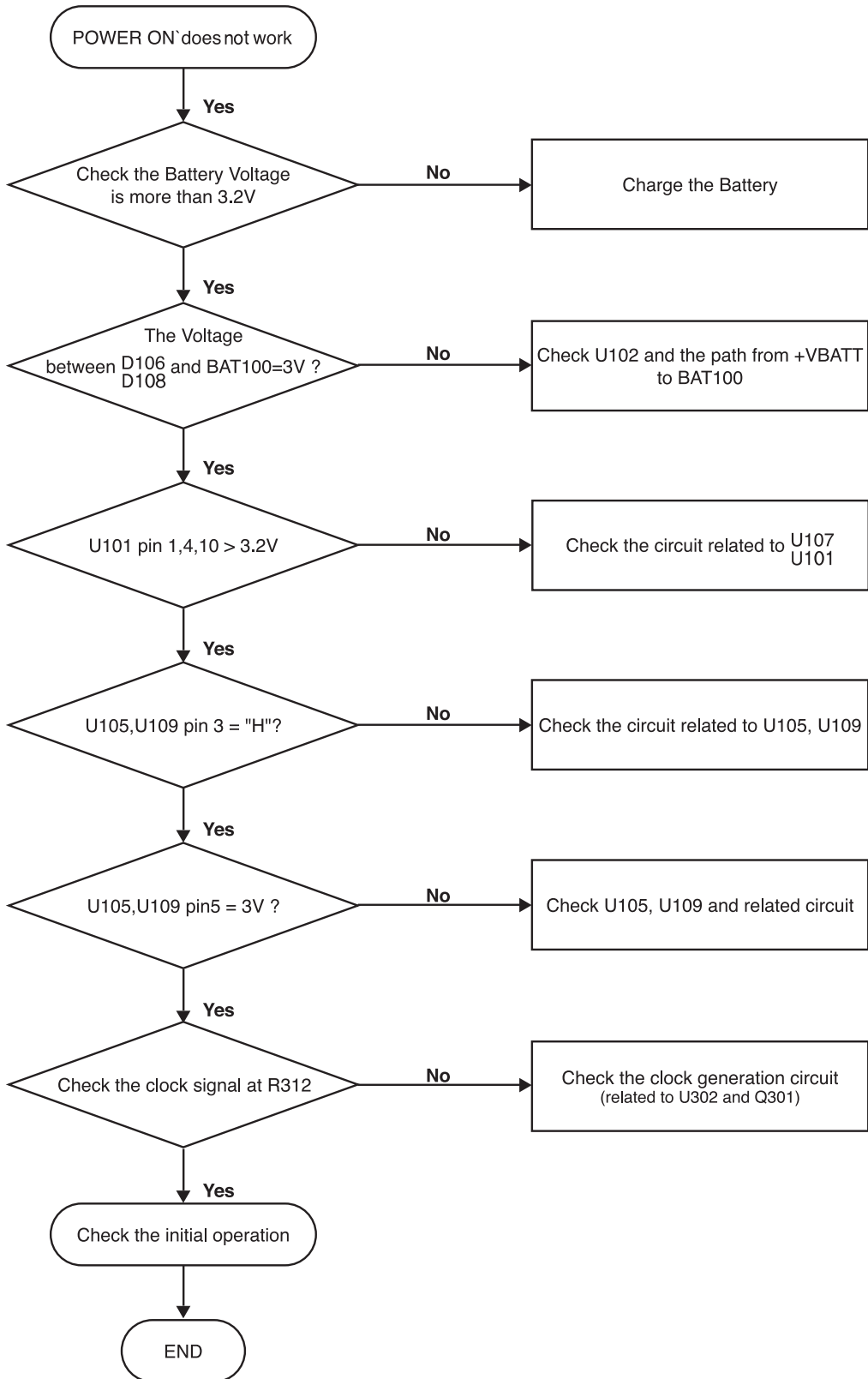

5-2 Initial

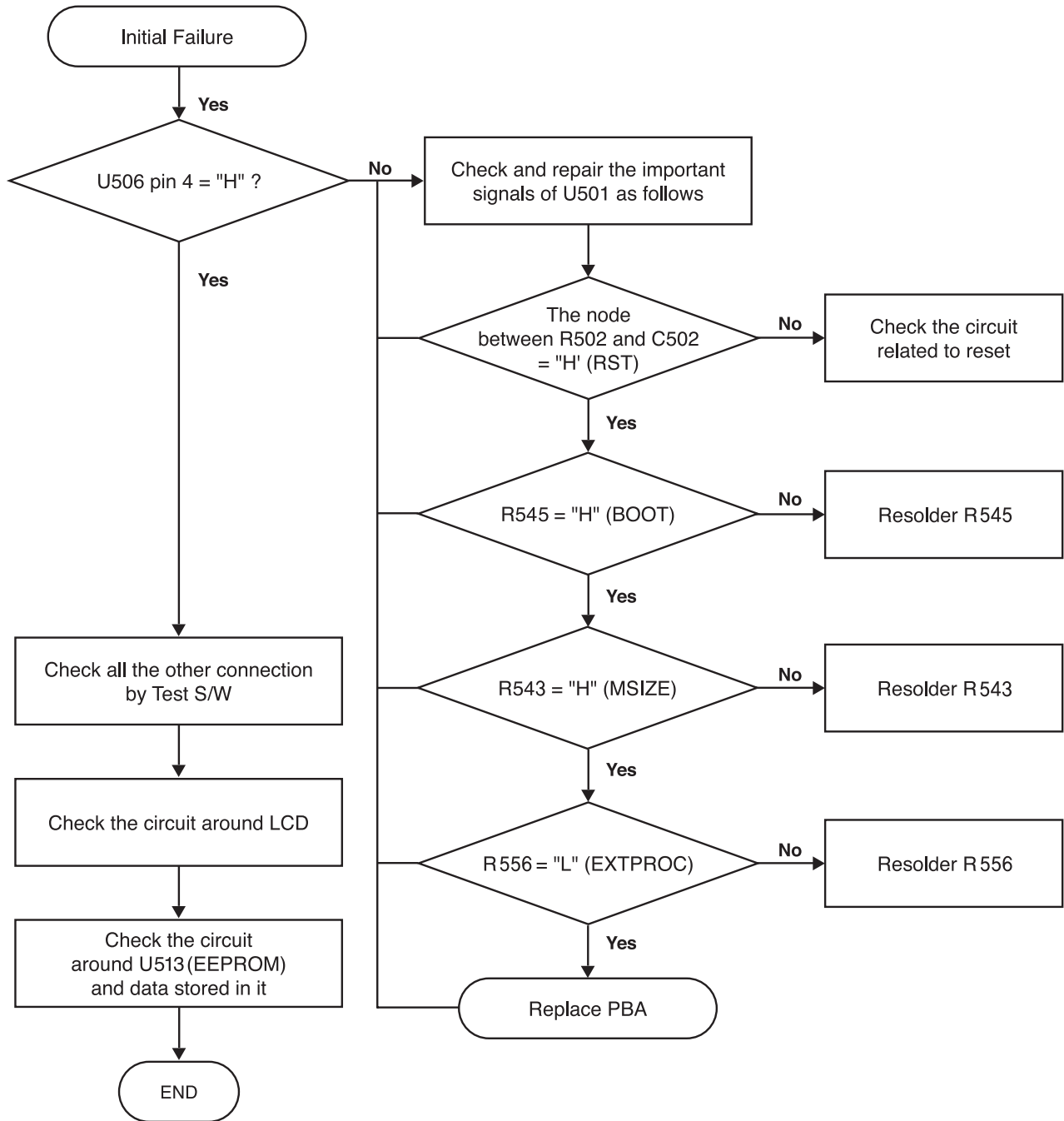

5-3 Charging Part

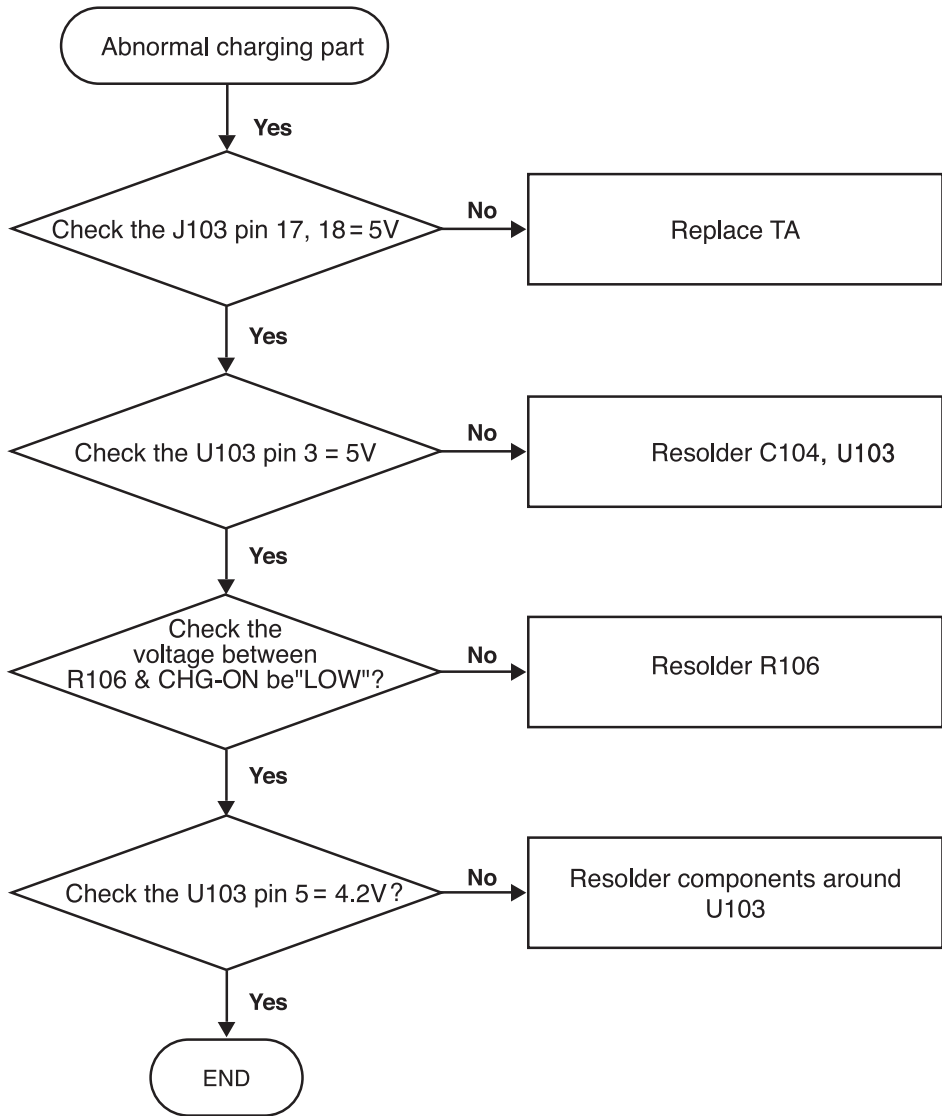

5-4 Sim Part

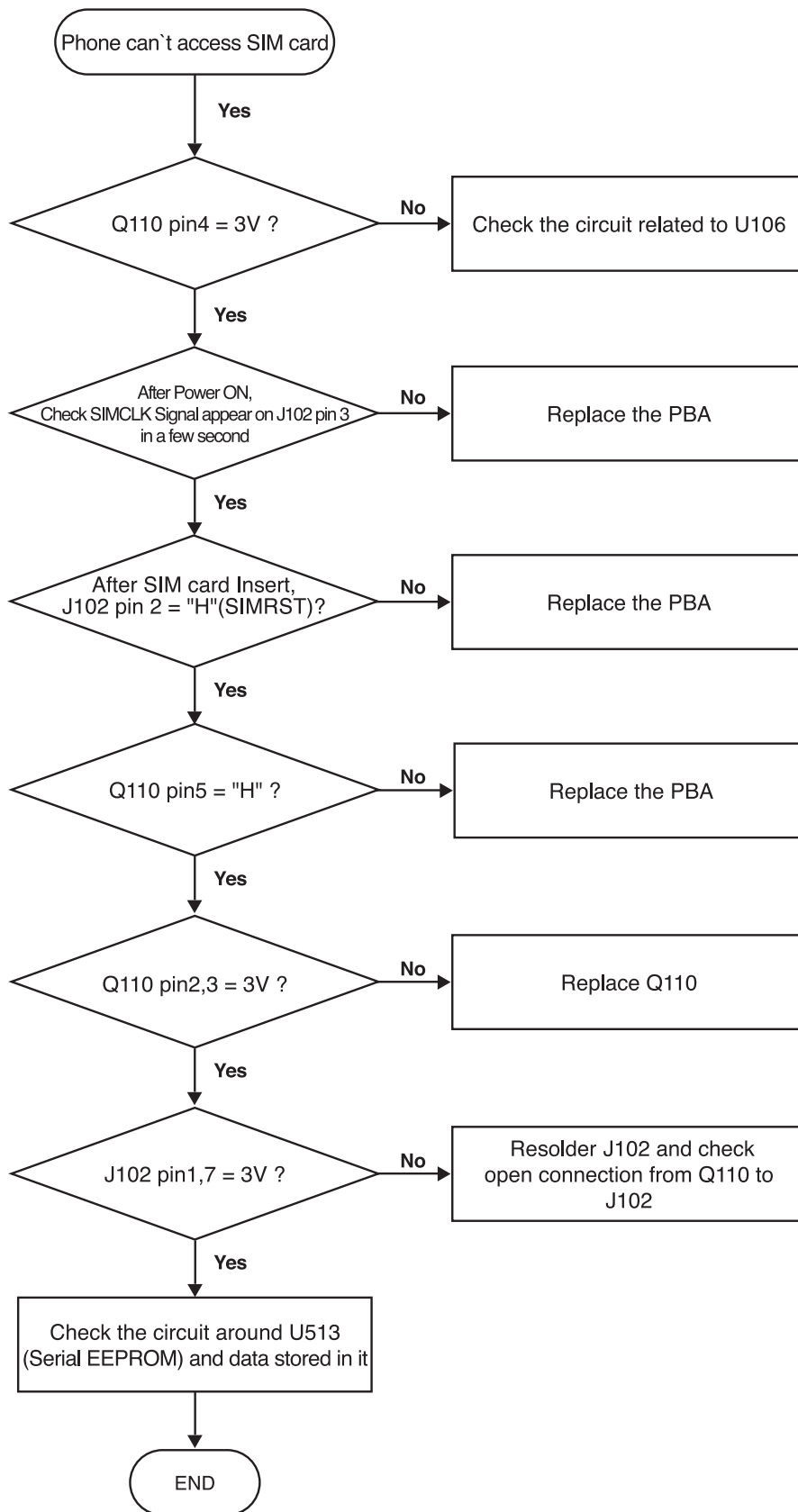

5-5 Microphone Part

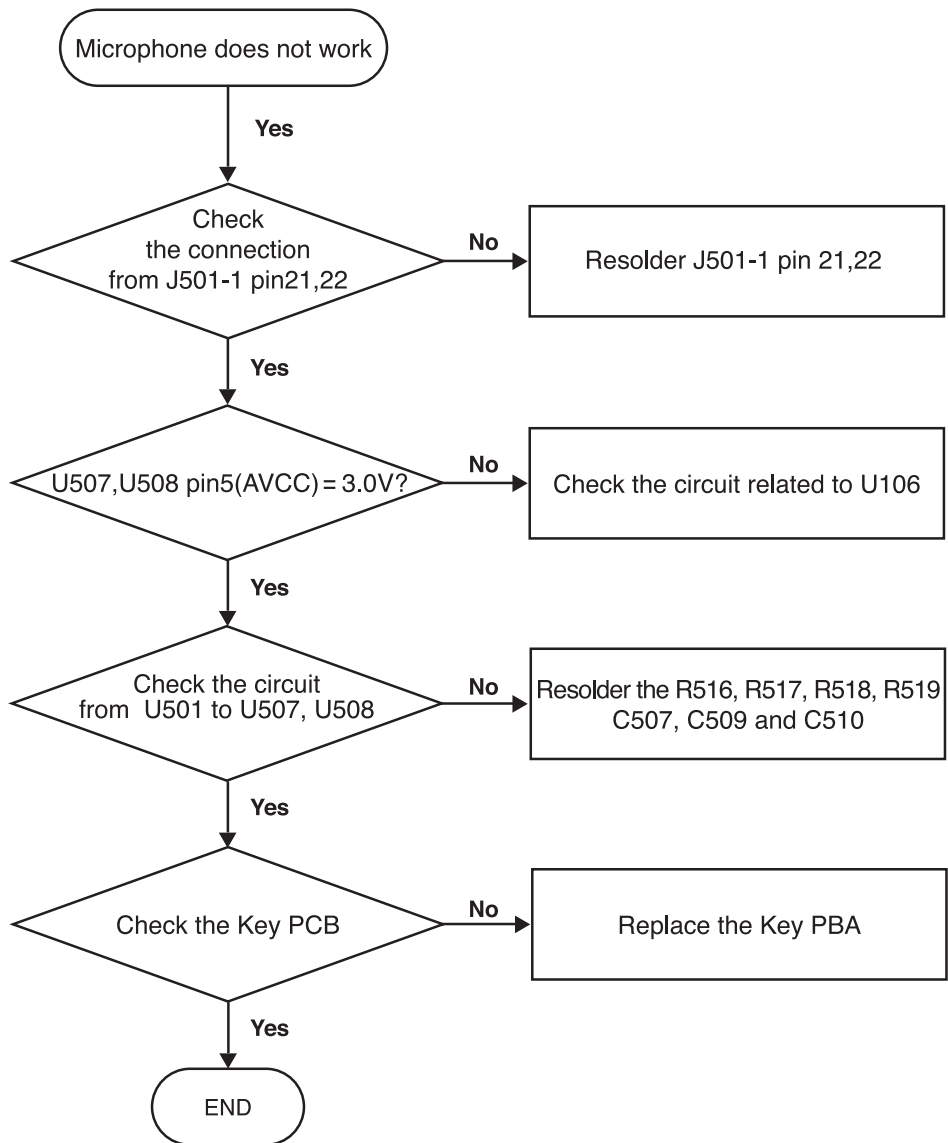

5-6 Speaker Part

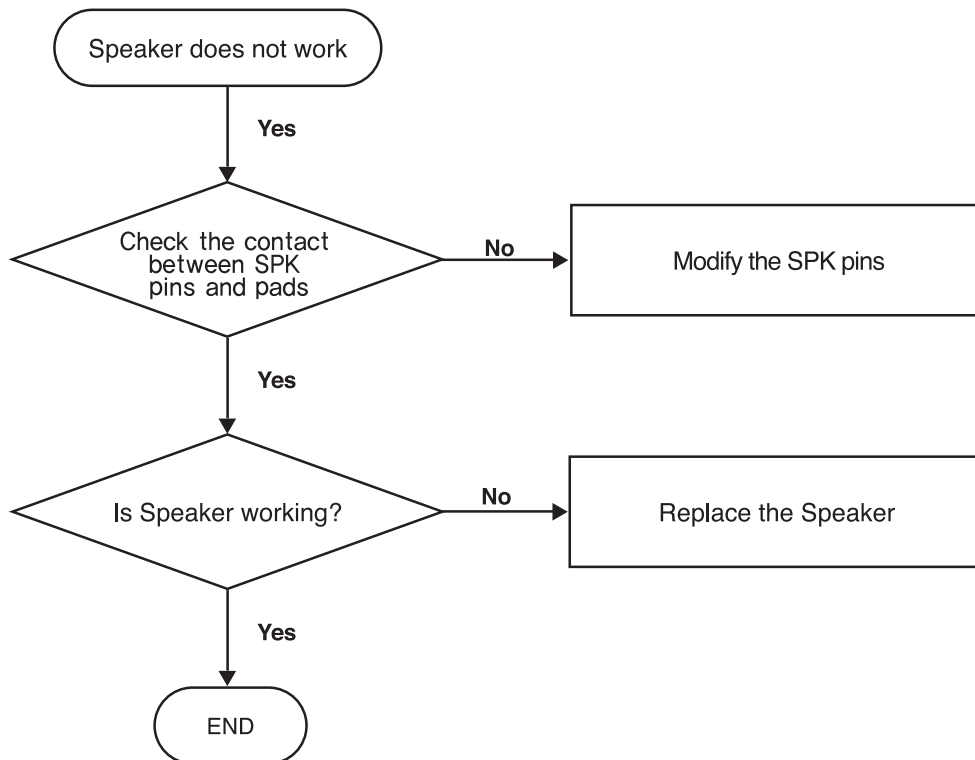

5-7 Key Data Input

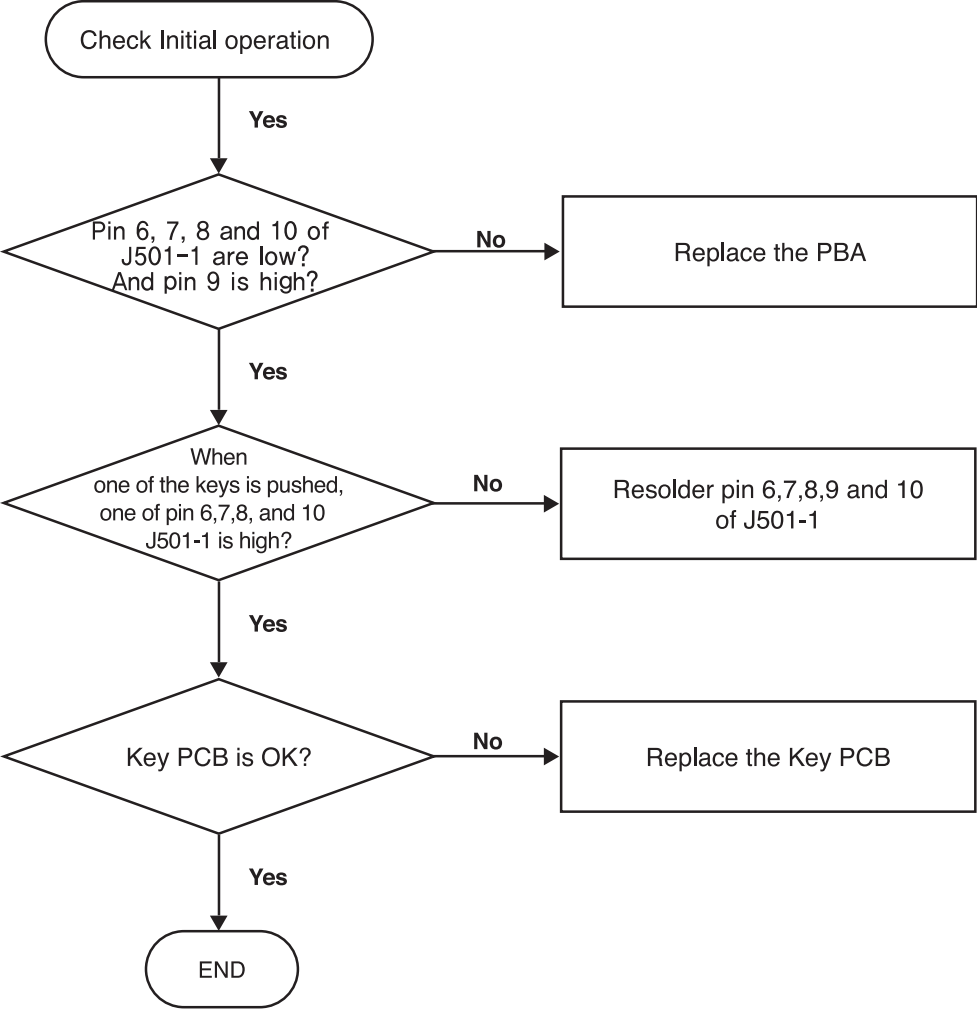

5-8 Alert Tone

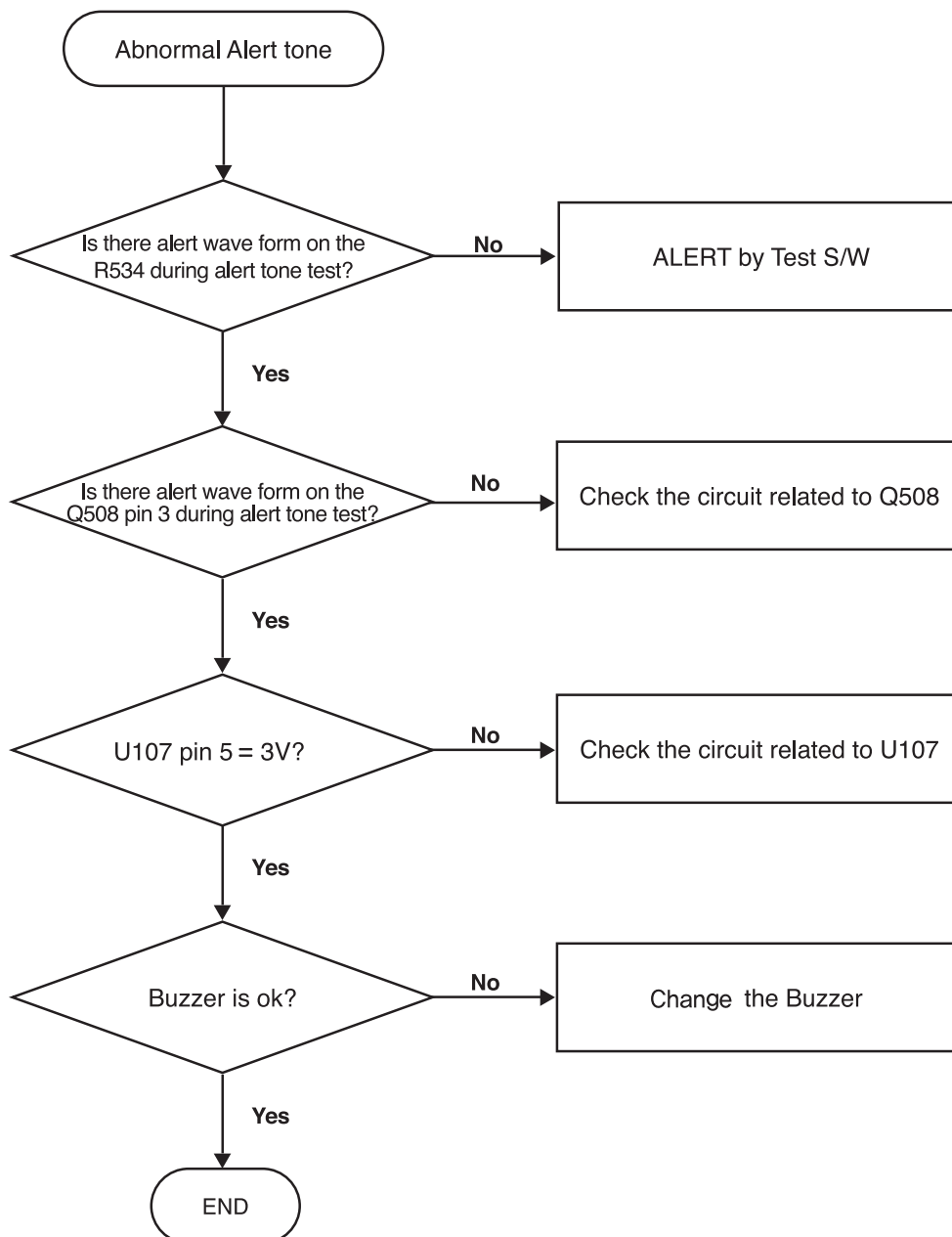

5-9 Ring Indicator

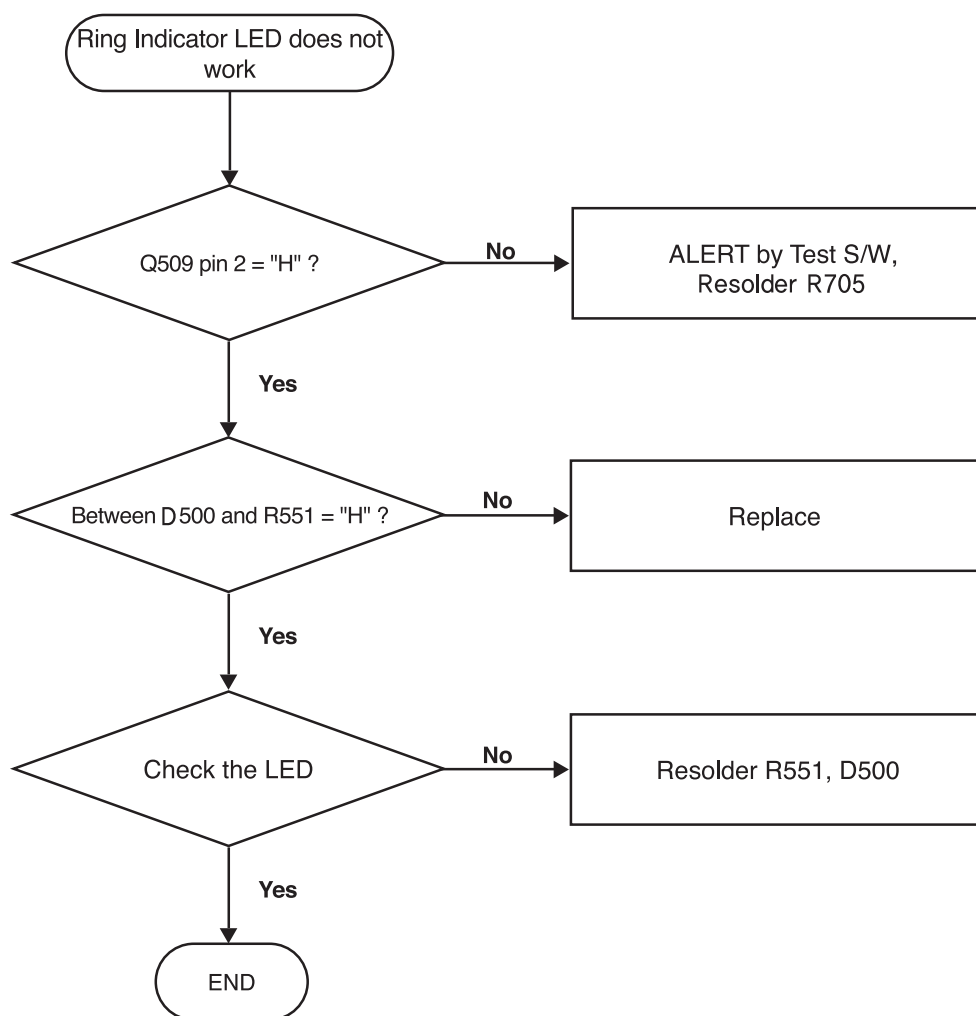

5-10 Back Light

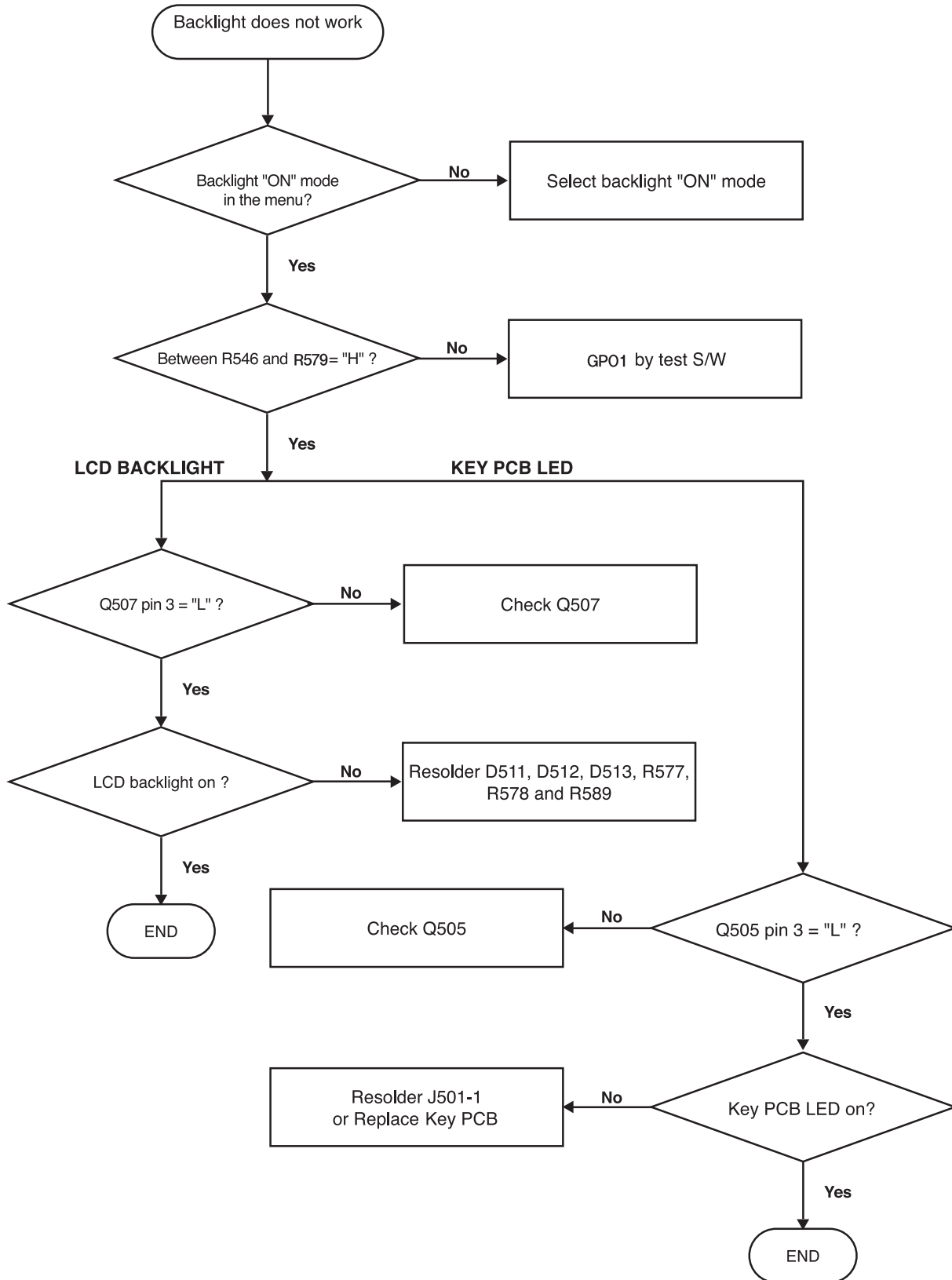

5-11 Auto Antenna Troubleshooting

Auto Antenna Troubleshooting

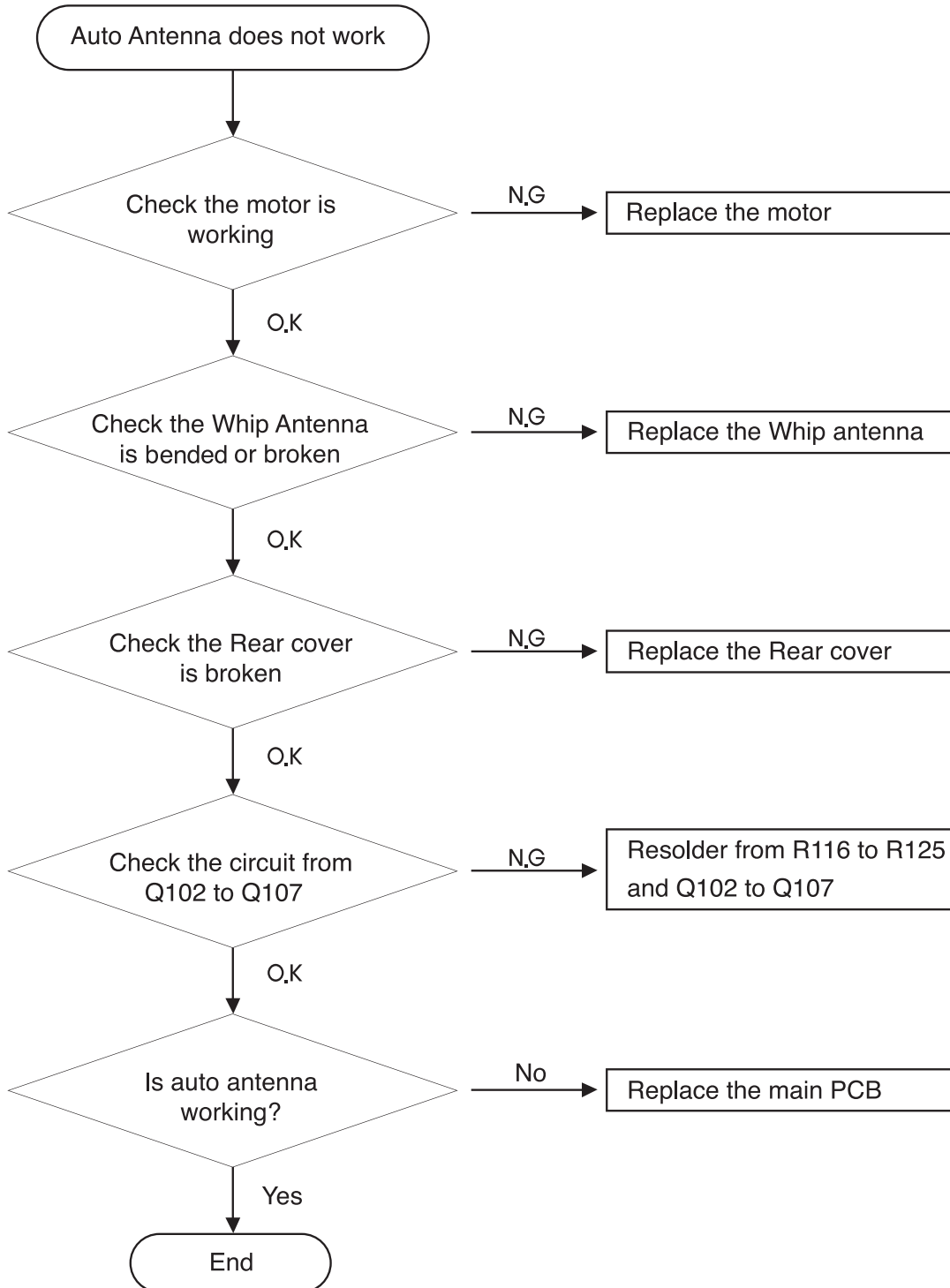

SGH-N400 RF Troubleshooting

Set EXT.ATT.1.5dB(GSM),2.1dB(DCS)
Set BCCH&TCH Rx Level -50dBm
Set Control Ch. 20, Traffic Ch. 60(GSM)
Set Control Ch. 520, Traffic Ch. 700(DCS)
Set HP8922 Mobile Test Menu

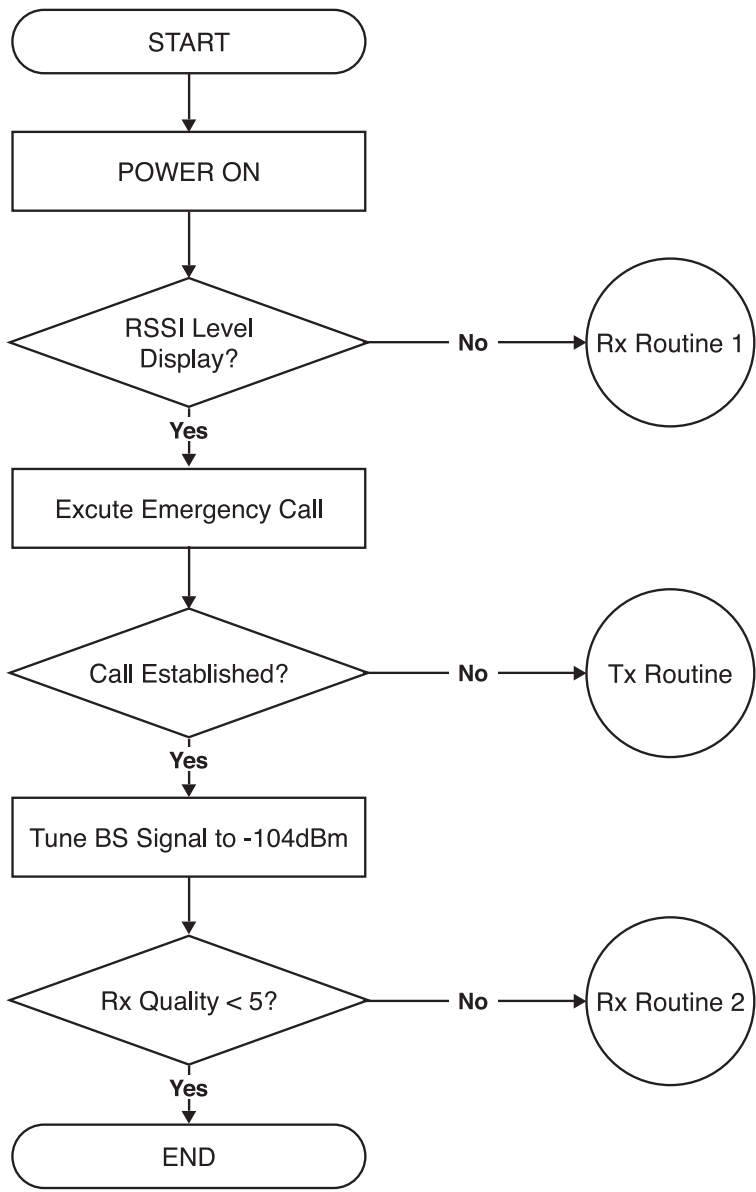

SGH-N400 Tx Troubleshooting

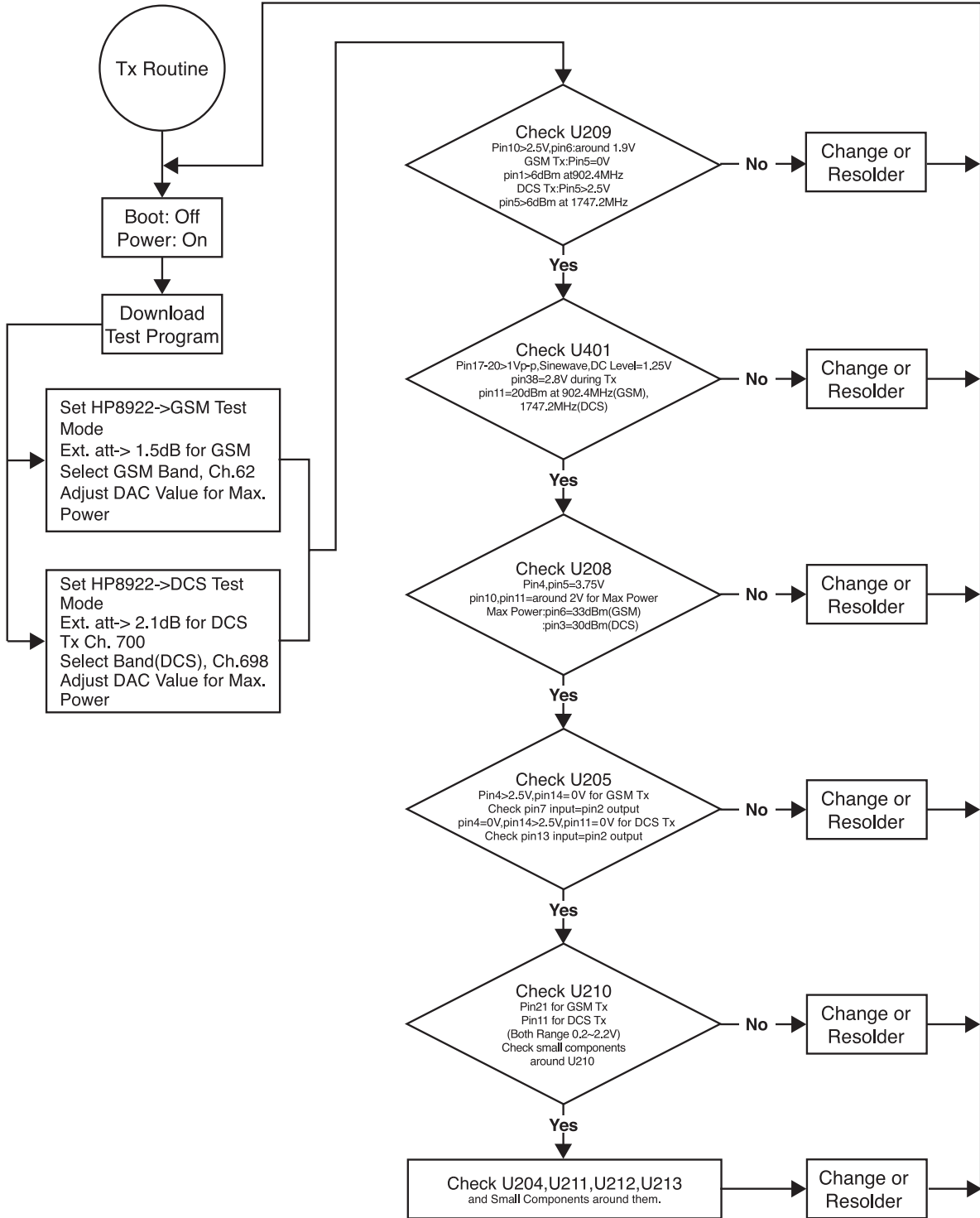

5-14 Rx Troubleshooting

SGH-N400 Rx Troubleshooting

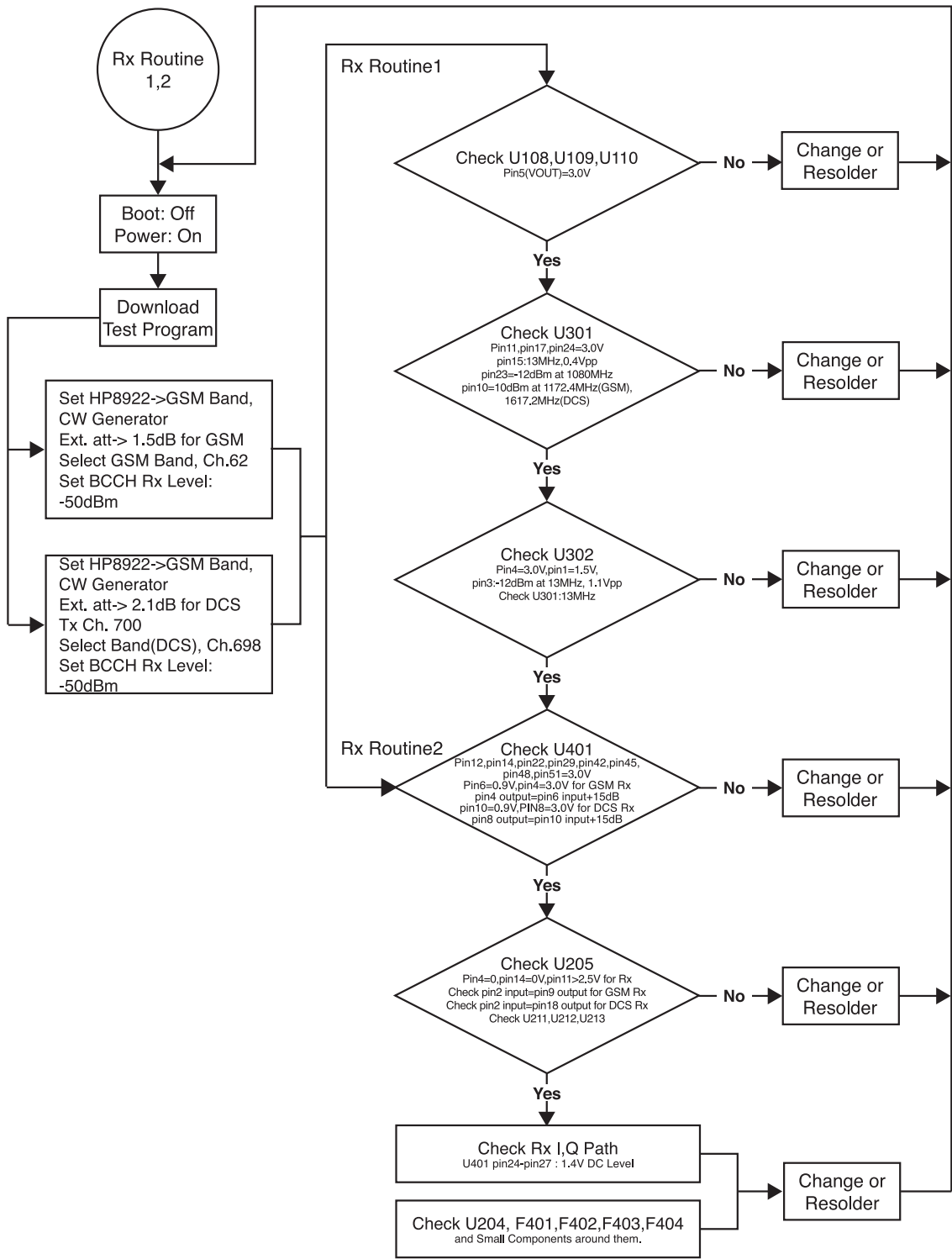

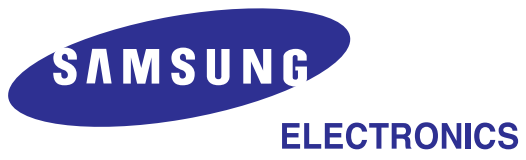

Samsung Electronics Co.,Ltd.
Printed in Korea
AUG. 2001 Rev 1.2
GH68-02304A