

Thank you for purchasing this Factory Service Manual CD/DVD from [servicemanuals4u.com](http://servicemanuals4u.com).

Please check out our eBay auctions for more great deals on Factory Service Manuals:

[servicemanuals4u](http://servicemanuals4u)

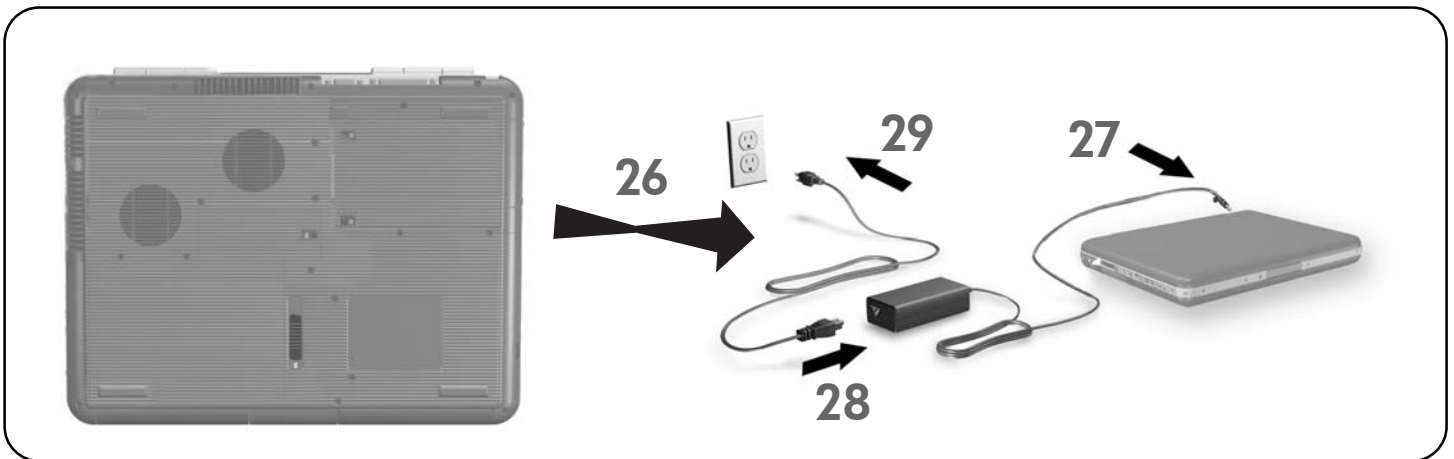
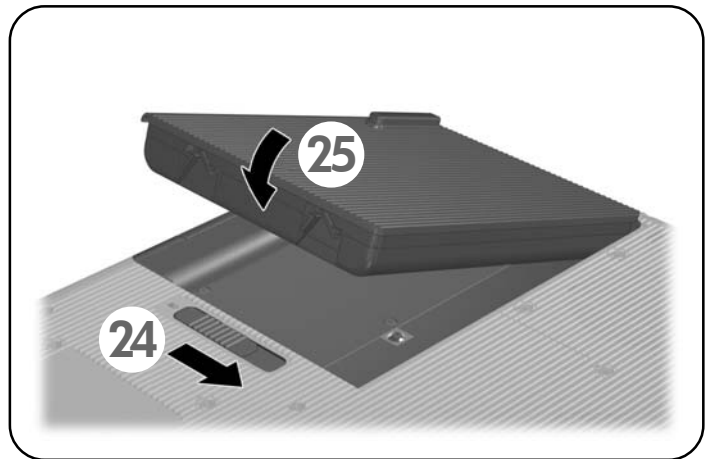
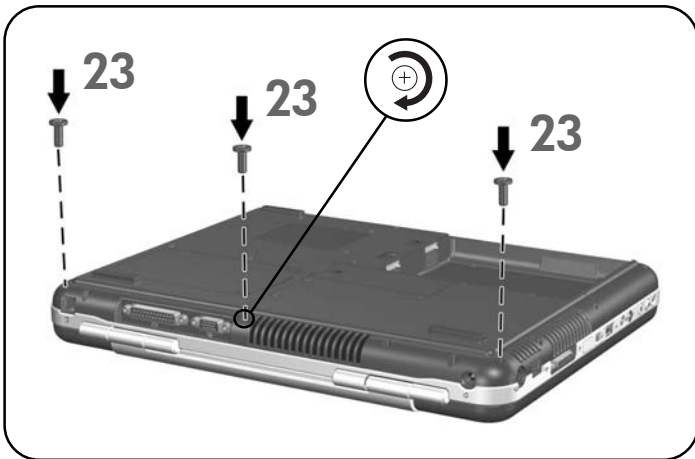
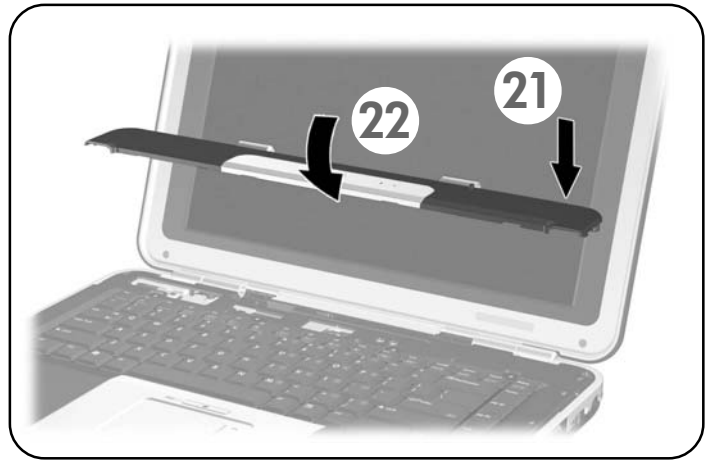
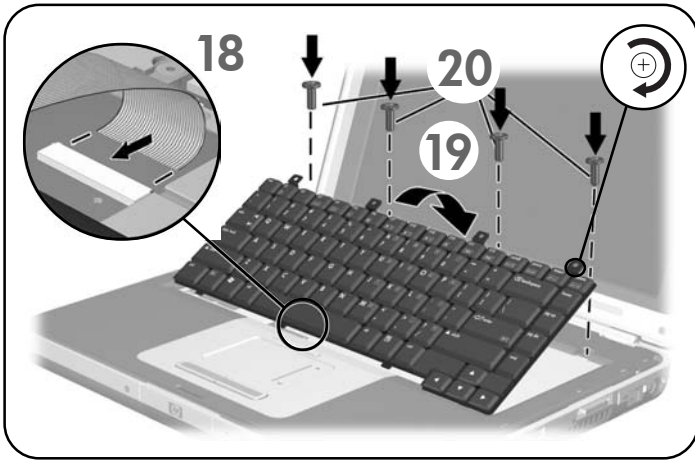

356500-001