



Hardware Guide

HP Compaq Notebook Series

Document Part Number: 309971-002

October 2003

This guide explains how to identify and use notebook hardware features, including connectors for external devices. It also includes power and environmental specifications, which may be helpful when traveling with the notebook.

Thank you for purchasing this Factory Service Manual CD/DVD from servicemanuals4u.com.

Please check out our eBay auctions for more great deals on Factory Service Manuals:

servicemanuals4u

© 2003 Hewlett-Packard Development Company, L.P.

Microsoft® and Windows® are U.S. registered trademarks of Microsoft Corporation. Intel® is a registered trademark of Intel Corporation or its subsidiaries in the United States and other countries. SD Logo is a trademark of its proprietor. Bluetooth® is a trademark owned by its proprietor and used by Hewlett-Packard Company under license.

The information contained herein is subject to change without notice. The only warranties for HP products and services are set forth in the express warranty statements accompanying such products and services. Nothing herein should be construed as constituting an additional warranty. HP shall not be liable for technical or editorial errors or omissions contained herein.

Hardware Guide
HP Compaq Notebook Series
Second Edition October 2003
First Edition April 2003
Reference Number: nc4010
Document Part Number: 309971-002

Contents

1 Hardware Features

Pointing Device Components	1-1
Top Components	1-2
Left-Side Components	1-4
Right-Side Components	1-5
Front Components	1-6
Rear Components	1-7
Bottom Components	1-8
Lights	1-10
Labels	1-11

2 Pointing Devices and Keyboard

Using a Pointing Device	2-1
Using the Pointing Stick	2-2
Using the TouchPad	2-3
Using an External Mouse	2-3
Setting Pointing Device Preferences	2-4
Using Hotkeys and Shortcut Keys	2-4
Identifying Fn and Function Keys	2-5
Hotkey and Shortcut Key Quick Reference	2-5
Hotkey and Shortcut Key Procedures	2-6
Hotkey and Shortcut Key Commands	2-6
Switching the Display (Fn+F4)	2-7
Viewing Battery Charge Information (Fn+F8)	2-7

- Decreasing Screen Brightness (Fn+F9) 2-7
- Increasing Screen Brightness (Fn+F10) 2-8
- Using Hotkeys and Shortcut Keys with External
Keyboards 2-8
- Using Quick Launch Buttons 2-9
- Using Keypads 2-10
 - Using the Embedded Numeric Keypad 2-10
 - Using an External Keypad 2-11

3 Battery Packs

- Running the Notebook on Battery Power 3-1
- Inserting or Removing the Primary Battery Pack 3-3
- Using the Optional Travel Battery Pack 3-6
 - Inserting or Removing the Battery Pack 3-6
 - Attaching or Detaching the Travel Battery Pack 3-8
- Charging a Battery Pack 3-11
- Monitoring the Charge of a Battery Pack 3-13
 - Obtaining Accurate Charge Information 3-13
 - Displaying Charge Information on the Screen 3-14
 - Displaying Charge Information on a Battery Pack 3-15
- Managing Low-Battery Conditions 3-16
 - Identifying Low-Battery Conditions 3-16
 - Resolving Low-Battery Conditions 3-17
- Calibrating a Battery Pack 3-18
 - When to Calibrate 3-19
 - How to Calibrate 3-19
- Conserving Battery Power 3-22
 - Conserving Power as You Work 3-22
 - Selecting Power Conservation Settings 3-23
- Storing a Battery Pack 3-24
- Disposing of a Used Battery Pack 3-25
- Finding More Power Information 3-25

4 Hard Drive

- Caring for Drives 4-1
- Hard Drive 4-2
 - Identifying the Hard Drive Activity Light. 4-2
- Replacing the Primary Hard Drive. 4-3

5 Audio and Video

- Using Audio Features. 5-1
 - Using the Audio Line-Out Jack. 5-2
 - Using the Microphone Input Jack 5-2
 - Adjusting the Volume 5-3
- Using Video Features. 5-3
 - Using the S-Video-Out Jack 5-4
 - Changing the Video Mode. 5-5

6 Communication Devices

- Connecting a Modem Cable. 6-1
 - Connecting the RJ-11 Modem Cable. 6-3
 - Using a Country-Specific Adapter Cable 6-4
- Connecting a Network Cable 6-5
- Linking to an Infrared Device 6-7
 - Setting Up an Infrared Transmission. 6-8
 - Avoiding Standby with Infrared 6-8
- Using Wireless LAN 6-9
- Using Bluetooth 6-9

7 External Devices

- Connecting a Monitor or Projector 7-2
- Using a USB Device 7-2
 - Enabling USB Legacy Support 7-3
- Connecting an Optional External MultiBay. 7-4
- Connecting an Optional Cable Lock 7-5

8 Hardware Upgrades

Using Optional PC Cards	8-1
Inserting a PC Card	8-2
Removing a PC Card	8-3
Using Optional SD Cards	8-4
Inserting an SD Card	8-4
Removing an SD Card	8-5
Adding and Upgrading Memory Modules	8-6
Adding a Memory Expansion Module	8-6
Upgrading the Memory Module in the Primary Memory Slot	8-10
Effects of Increasing Memory	8-14

9 Specifications

Operating Environment	9-1
Rated Input Power	9-2
Modem Specifications	9-2

Index

Hardware Features

Pointing Device Components



Component	Description
① Pointing stick	Moves the pointer and selects or activates items on the screen.
② Left and right pointing stick buttons	Function like the left and right buttons on an external mouse.
③ TouchPad	Moves the pointer and selects or activates items on the screen. Can be set to perform other mouse functions, such as scrolling and double-clicking.
④ Left and right TouchPad buttons	Function like the left and right buttons on an external mouse.

Top Components

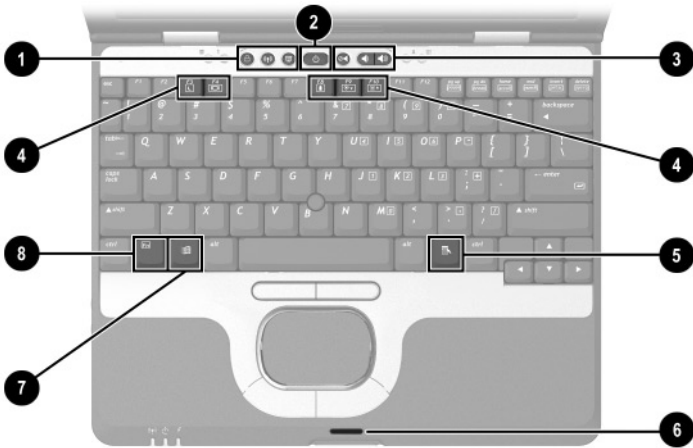

	Component	Description
1	Quick Launch buttons (3)	Enable you to access common functions with a single keystroke.
2	Power button	<p>When the notebook is*</p> <ul style="list-style-type: none"> ■ Off, press and release to turn on the notebook. ■ In Standby, press and release to exit Standby. ■ In Hibernation, press and release to exit Hibernation. <p>If the system has stopped responding and Microsoft® Windows® shutdown procedures cannot be used, press and hold for 5 seconds to turn off the notebook.</p>

*This table describes default settings. For information about changing the functions of the power button and about using Standby and Hibernation, refer to the “Power” chapter in the *Software Guide* on the *Documentation Library* CD.

(continued)

	Component	Description
③	Volume control buttons	Increase, decrease, and mute the system volume.
④	Function keys	Execute frequently used system functions when pressed in combination with the Fn key.
⑤	Applications key	Displays shortcut menu for items beneath the pointer.
⑥	Display release latch recess	Secures the display when it is closed.
⑦	Windows logo key	Displays the Windows Start menu.
⑧	Fn key	Executes frequently used system functions when pressed in combination with another key.
Not shown	Primary memory compartment (not shown, located under the keyboard)	Contains the primary memory slot.

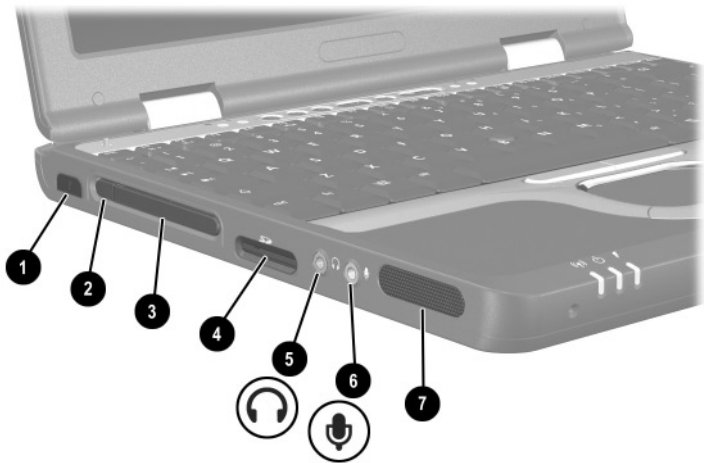

Left-Side Components

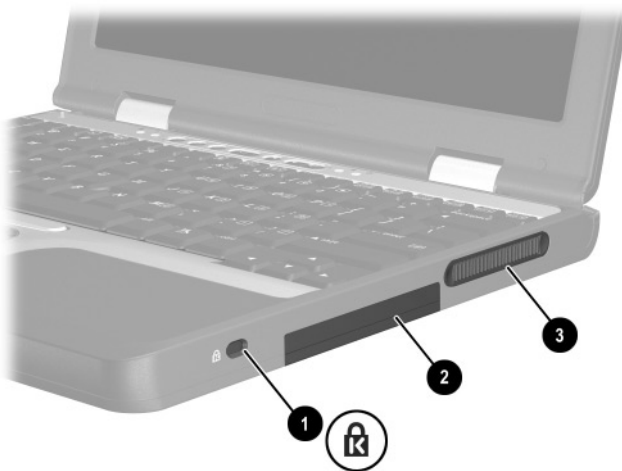

Component	Description
❶ Infrared port	Links another IrDA-compliant device for wireless communication.
❷ PC Card eject button	Ejects an optional PC Card from the PC Card slot.
❸ PC Card slot	Supports optional Type I or Type II 32-bit (CardBus) or 16-bit PC Cards.
❹ Secure Digital (SD) Card slot	Accepts SD Memory Cards used as removable storage devices.
❺ Audio line-out jack	Connects optional powered stereo speakers, headphones, headset, or television audio.
❻ Microphone input jack	Connects an optional microphone.
❼ Speaker	Produces system sound.

Right-Side Components



Component	Description
1 Security cable slot	Attaches an optional security cable to the notebook.  The purpose of security solutions is to act as a deterrent. These solutions do not prevent the product from being mishandled or stolen.
2 Hard drive bay	Holds the primary hard drive.
3 Exhaust vent	Enables airflow to cool internal components.  To prevent overheating, do not obstruct vents. Using the notebook on a soft surface such as a pillow, blanket, rug, or thick clothing can block airflow.

Front Components

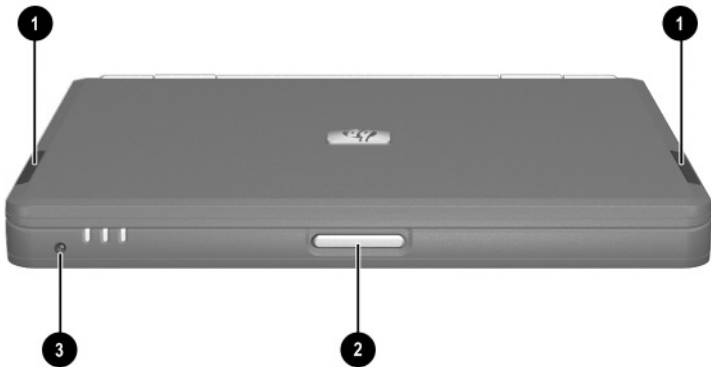

Component	Description
1 Antennae	Send and receive wireless LAN (WLAN) signals. △ The antennae covers are not removable. Removing the covers can cause damage to the antennae.
2 Display release latch	Opens the notebook.
3 Microphone	Inputs single-channel sound.
⚠ Exposure to Radio Frequency Radiation The radiated output power of this device is below the FCC radio frequency exposure limits. Nevertheless, the device should be used in such a manner that the potential for human contact during normal operation is minimized. To avoid the possibility of exceeding the FCC radio frequency exposure limits, human proximity to the antenna should not be less than 20 cm (8 inches) during normal operation, including when the notebook display is closed.	

Rear Components

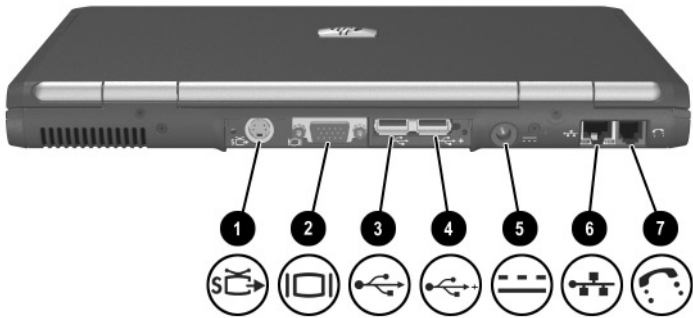

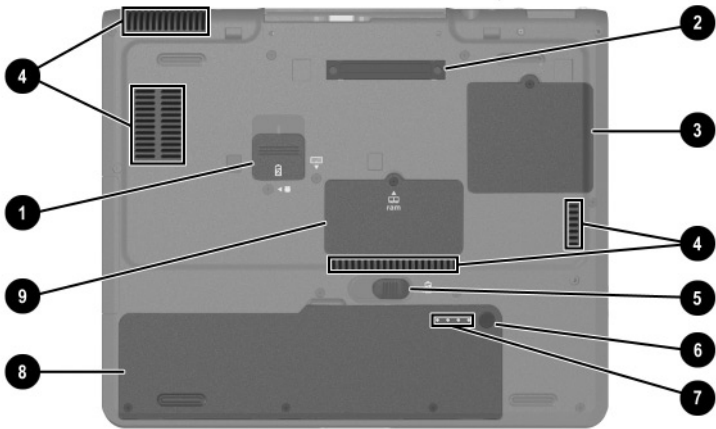

Component	Description
❶ S-Video-out jack	Connects an optional S-Video device, such as a television, VCR, camcorder, overhead projector, or video capture card.
❷ External monitor connector	Connects an optional external monitor or overhead projector.
❸ USB connector	Connects USB 1.1- and 2.0-compliant devices to the notebook using a standard USB cable.
❹ Self-powered USB connector	Connects USB 1.1- and 2.0-compliant devices to the notebook using a standard USB cable, or an optional External MultiBay to the notebook using the External MultiBay-Powered USB cable.
❺ AC power connector	Connects an AC adapter or an optional Automobile Power Adapter/Charger or Aircraft Power Adapter.
❻ RJ-45 network jack	Connects a network cable.
❼ RJ-11 telephone jack	Connects a modem cable.

Bottom Components



Component	Description
1 Travel battery connector	Connects the optional travel battery caddy. The travel battery connector has a plastic cover that must be opened before the travel battery caddy is connected.
2 Docking connector	Connects the notebook to an optional HP Port Replicator or an HP Advanced Port Replicator.

(continued)

Component	Description
<p>③ Mini PCI compartment</p>	<p>Contains the Mini PCI wireless card.</p> <p> The FCC does not allow unauthorized Mini PCI devices to be used in this notebook. Installing an unauthorized Mini PCI device can prevent your notebook from operating properly and might result in a warning message. To resume proper notebook operation, remove the unauthorized device. Contact your HP Customer Care Center if a warning message about your Mini PCI device displays in error.</p>
<p>④ Intake vents</p>	<p>Enable airflow to cool internal components.</p> <p> To prevent overheating, do not obstruct vents. Using the notebook on a soft surface such as a pillow, blanket, rug, or thick clothing can block airflow.</p>
<p>⑤ Battery release latch</p>	<p>Releases the primary battery pack from the battery bay.</p>
<p>⑥ Quick Check button</p>	<p>Displays the percentage of a full charge remaining on a battery pack using the Quick Check lights.</p>
<p>⑦ Battery power gauge</p>	<p>Indicates the charge remaining on a battery pack.</p>
<p>⑧ Battery bay</p>	<p>Holds the primary battery pack.</p>
<p>⑨ Memory expansion compartment</p>	<p>Contains 1 memory expansion slot for optional memory expansion boards.</p>

Lights

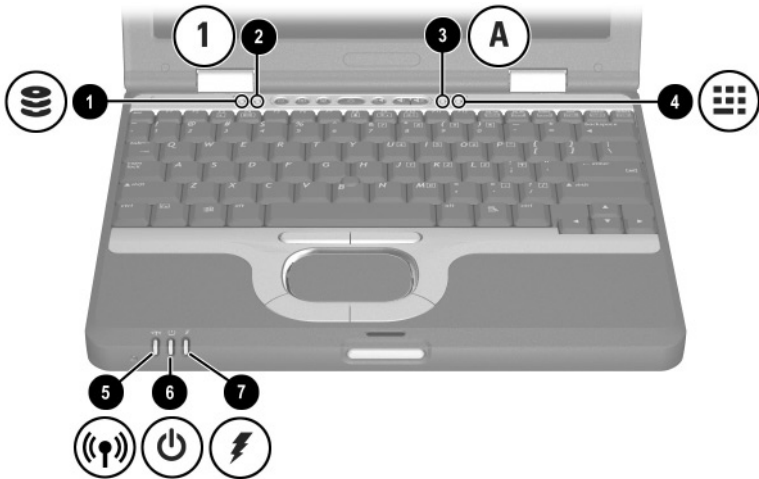

Component	Description
① Hard drive activity	On: The hard drive is being accessed.
② Num lock	On: Num lock is on or the embedded numeric keypad is enabled.
③ Caps lock	On: Caps lock is on.
④ Scroll lock	On: Scroll lock is on.
⑤ Wireless on/off	On: The wireless Mini PCI card and/or Bluetooth® are on. Off: The wireless Mini PCI card and Bluetooth are off.
⑥ Power/Standby	On: Power is turned on. Blinking: Notebook is in Standby.
⑦ Battery	On: A battery pack is charging. Blinking: A battery pack that is the only available power source has reached a low-battery condition. When the battery reaches a critical low-battery condition, the battery light begins blinking more quickly.

Labels

The labels affixed to the bottom of the notebook and to the inside of the battery compartment provide information you may need when you troubleshoot system problems or travel abroad with the notebook.

- The Service Tag label affixed to the bottom of the notebook contains the product name, product number (P/N), and serial number (S/N). You will need the notebook serial number and product number if you call customer support.
- The Microsoft Certificate of Authenticity label affixed to the bottom of the notebook contains the Product Key number. You may need this number to update or troubleshoot problems with the operating system.
- The System label affixed to the bottom of the notebook provides regulatory information about the notebook.
- The Modem Approval label affixed to the bottom of the notebook provides regulatory information and lists the agency markings required by some of the countries in which the modem has been approved for use. You may need to use this modem information in order to operate the modem while traveling internationally.
- The WLAN label affixed to the bottom of the notebook provides regulatory information and lists the agency markings required by some of the countries in which the optional wireless devices have been approved for use. You may need to use this wireless device information in order to operate the wireless device while traveling.
- The Bluetooth® label affixed to the bottom of the notebook provides regulatory information and lists the agency markings required by some of the countries in which the optional device has been approved for use. You may need to use this wireless device information in order to operate the wireless device while traveling internationally. Bluetooth is not supported in all countries.

Pointing Devices and Keyboard

Using a Pointing Device

By default, the pointing stick and TouchPad components can be used interchangeably.



Pointing device components

Component	Description
❶ Pointing stick	Moves the pointer and selects or activates items on the screen.
❷ Left and right pointing stick buttons	Function like the left and right buttons on an external mouse.

(continued)

Component	Description
③ TouchPad	Moves the pointer and selects or activates items on the screen. Can be set to perform other mouse functions, such as scrolling and double-clicking.
④ Left and right TouchPad buttons	Function like the left and right buttons on an external mouse.

Using the Pointing Stick

To move the pointer, press the pointing stick in the direction you want to move the pointer. Use the left and right pointing stick buttons as you would the left and right buttons on an external mouse.

To change the pointing stick cap:

1. Save your work, exit all applications, and shut down the notebook. If you are not sure whether the notebook is off or in Hibernation, briefly press the power button. If your work returns to the screen, save your work, exit all applications, and then shut down the notebook.
2. Gently pull off the used pointing stick cap.

3. Push a replacement cap into place.

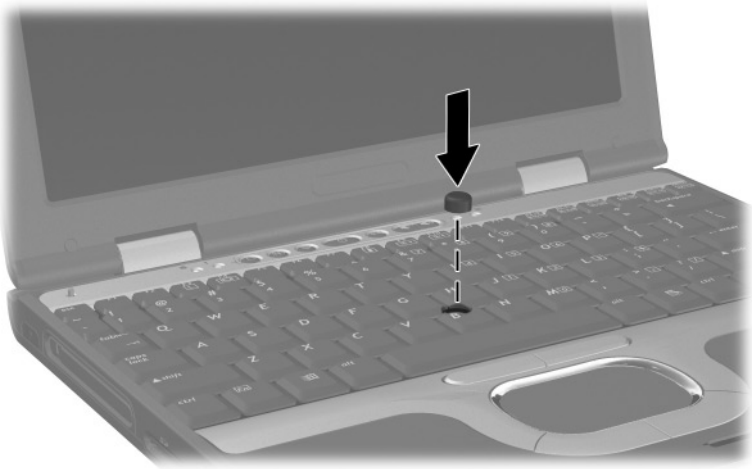

Replacing the pointing stick cap

Using the TouchPad

To move the pointer, slide your finger across the TouchPad surface in the direction you want to move the pointer. Use the left and right TouchPad buttons as you would the left and right buttons on an external mouse.

Using an External Mouse

An external USB mouse can be connected to the notebook using one of the USB connectors on the back panel. An external PS/2 or USB mouse can be connected to the system using the connectors on an optional HP Port Replicator or an HP Advanced Port Replicator.

Setting Pointing Device Preferences

Mouse Properties in Windows enables you to change custom settings for pointing devices, including:

- Enabling or disabling a pointing device.
- TouchPad tapping, which enables you to tap the TouchPad once to select an object or twice to double-click an object.
- Edge motion, which enables you to continue to scroll even though your finger has reached the edge of the TouchPad.
- Palm Check, which helps prevent moving the pointer unintentionally if your palms contact the TouchPad as you type.

Other features, such as mouse speed preferences and mouse trails, are also found in the Mouse Properties windows.

To access Mouse Properties:

- **In Windows XP**, select Start > Control Panel > Printers and Other Hardware > Mouse icon.
- **In Windows 2000**, select Start > Settings > Control Panel > Mouse icon.

Using Hotkeys and Shortcut Keys

Hotkeys and shortcut keys are preset combinations of the **Fn** key with other keys on the keyboard.

- A hotkey is a combination of the **Fn** key and one of the function keys. The icons on the function keys represent the hotkey functions available on your notebook.
- A shortcut key is a combination of the **Fn** key and a key other than a function key.

Identifying Fn and Function Keys



Fn and function keys

Component

- ❶ Fn key
 - ❷ Function keys
-

Hotkey and Shortcut Key Quick Reference

Function	Key Combination to Activate Function	Key Combination to Deactivate Function
Initiate Standby	Fn+F3	Power button
Switch display and image	Fn+F4	Fn+F4
View battery information	Fn+F8	Fn+F8
Decrease display brightness.	Fn+F9	N/A
Increase display brightness.	Fn+F10	N/A
Display system information	Fn+esc	Fn+esc

Hotkey and Shortcut Key Procedures

To use a hotkey or shortcut key command on the notebook keyboard, use either of the following procedures:

- Briefly press the **Fn** key, and then briefly press the second key of the hotkey command.
- Press and hold down the **Fn** key, briefly press the second key of the hotkey command, and then release both keys at the same time.

Hotkey and Shortcut Key Commands

Displaying System Information (Fn+esc)

Press **Fn+esc** to display information about system hardware components and software version numbers. Press **Fn+esc** a second time to remove the system information from the screen.



The system BIOS date is the version number of the system ROM. The BIOS date may display in a decimal format, for example, 10/19/2002 F.07.

Initiating Standby (Fn+F3)

The **Fn+F3** hotkey is set by default to initiate Standby. Standby can be initiated only while the notebook is on. If the notebook is in Hibernation, you must restore from Hibernation before you can initiate Standby.

To restore from Hibernation or resume from Standby, briefly press the power button. For more information about using Standby and Hibernation, refer to the “Power” chapter in the *Software Guide* on the *Documentation Library* CD.

Switching the Display (Fn+F4)

The **Fn+F4** hotkey switches the image between display devices connected to the external monitor connector or the S-Video jack on the notebook. For example, if an external monitor is connected to the notebook, pressing the **Fn+F4** hotkey multiple times will toggle the image between the notebook display, the external monitor display, and a simultaneous display on both the notebook and the monitor.

Most external monitors receive video information from the notebook using the external VGA video standard. The **Fn+F4** hotkey can also toggle images between other devices receiving video information from the notebook.

The following five video transmission types, with examples of devices that use them, are supported by the **Fn+F4** hotkey:

- LCD (notebook display)
- External VGA (most external monitors)
- S-Video (televisions, camcorders, VCRs, and video capture boards with S-Video-in jacks)

Viewing Battery Charge Information (Fn+F8)

Press **Fn+F8** to display charge information for all installed battery packs. The display indicates which battery packs are charging and reports the amount of charge remaining in each battery pack.

Battery pack locations are indicated by number:

- Location 1 is the primary battery pack.
- Location 2 is the travel battery pack.

Decreasing Screen Brightness (Fn+F9)

The **Fn+F9** hotkey decreases notebook screen brightness. Hold down the hotkey to decrease the brightness level incrementally.

Increasing Screen Brightness (Fn+F10)

The **Fn+F10** hotkey increases notebook screen brightness. Hold down the hotkey to increase the brightness level incrementally.

Using Hotkeys and Shortcut Keys with External Keyboards

The following hotkeys and shortcut keys can be used as described with external keyboards:

- **Fn+esc**
- **Fn+F8**

To use hotkeys or shortcut keys on an external keyboard, press the scroll lock key twice, and then the other key of the hotkey combination. For example, to use the **Fn+F8** hotkey, press **scroll lock+scroll lock+F8**.

Using Quick Launch Buttons

The 3 Quick Launch buttons enable you to access common functions with a single keystroke.

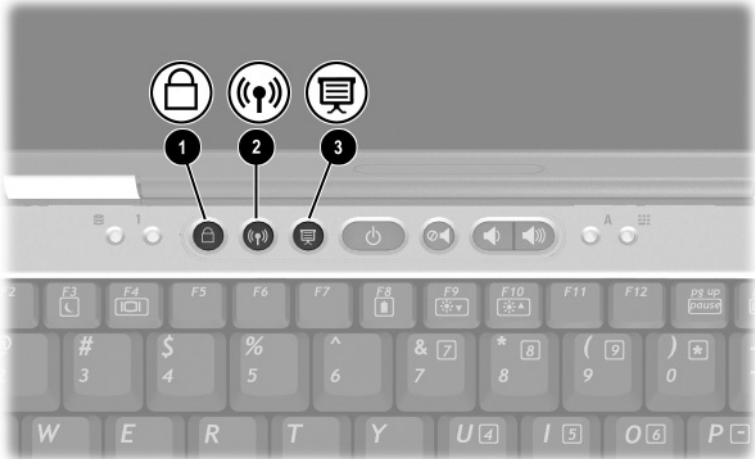

Quick Launch buttons

Component	Description
❶ QuickLock button	Disables the keyboard and pointing device and clears the display. Before you can use QuickLock, you must set a password and select preferences. For more information, refer to the “Security” chapter in the <i>Software Guide</i> on the <i>Documentation Library CD</i> .
❷ Wireless On/Off button	Turns the wireless LAN or optional Bluetooth device on and off when these devices are enabled in the software utilities.
❸ Presentation Mode button	Sets the notebook to presentation mode, which opens a user-defined application, folder, file, or Web site. The image simultaneously displays on the notebook screen and an external device connected to the external monitor connector or S-Video-out jack on the rear panel or to connectors on an optional Port Replicator.

Using Keypads

The notebook has an internal numeric keypad and supports an optional external numeric keypad or an optional external keyboard that includes a numeric keypad.

Using the Embedded Numeric Keypad

The 15 keys of the embedded numeric keypad can be used like the keys on an external keypad. When the internal keypad is turned on, each key on the internal keypad performs the functions indicated by the icon in the upper right corner of the key.

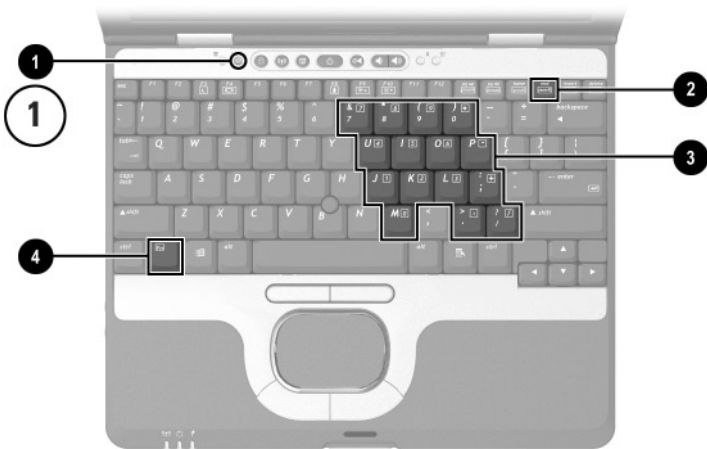

Embedded numeric keypad components

Component	
1	Num lock light
2	Num Lk key
3	Embedded numeric keypad
4	Fn key

Enabling and Disabling the Internal Keypad

Press **Fn+num lk** to enable the embedded numeric keypad. The num lock light turns on. Press **Fn+num lk** again to return the keys to their standard keyboard functions.



The numeric keypad cannot be enabled while an optional external keyboard or keypad is connected to the notebook or to an optional Port Replicator.

Switching Key Functions on the Internal Keypad

You can temporarily switch the functions of keys on the internal keypad between their standard keyboard functions and their keypad functions by using the **Fn** key or the **Fn+shift** key combination.

- To change the functions of a keypad key to keypad functions while the keypad is off, press and hold the **Fn** key while pressing a keypad key.
- To use the keypad keys temporarily as standard keys while the keypad is on:
 - Press and hold the **Fn** key to type in lowercase.
 - Press and hold **Fn+shift** to type in uppercase.

Using an External Keypad

Most keys on most external keypads function differently when num lock mode is on than when num lock mode is off. For example:

- When num lock mode is on, most keypad keys type numbers.
- When num lock mode is off, most keypad keys function like arrow, page up, or page down keys.

When num lock mode on an external keypad is turned on, the num lock light on the notebook turns on. When the num lock mode on an external keypad is turned off, the num lock light on the notebook turns off.

If the external keypad is connected, the internal keypad cannot be turned on.

Enabling or Disabling Num Lock Mode as You Work

To turn num lock mode on or off on an external keypad as you work, press the **num lk** key on the external keypad, not on the notebook.

Enabling or Disabling Num Lock Mode at Startup

To set the notebook to start up with a connected external keypad in num lock mode, set your preference in Computer Setup. For more information about using Computer Setup, refer to the “Computer Setup” chapter in the *Software Guide* on the *Documentation Library CD*.

To set the notebook to start up with the external keypad enabled:

1. Turn on or restart the notebook.
2. Press **F10** while the F10 = ROM Based Setup message is displayed in the lower left corner of the screen.
 - To change the language, press **F2**.
 - For navigation instructions, press **F1**.
3. Select Advanced > Device Options, and then press **enter**.
4. Select or clear the Num Lock State at Boot field:
 - To start up an external keypad with num lock mode turned on, select the field.
 - To start up an external keypad with num lock mode turned off, clear the field.
5. Press **F10**.
6. To save your preference and exit Computer Setup, select File > Save Changes and Exit, and then follow the instructions on the screen.

Your preference is set as you exit Computer Setup and is in effect when the notebook restarts.

Battery Packs

Running the Notebook on Battery Power

When the notebook is connected to external AC power, the notebook runs on AC power.

When a charged battery pack is in the notebook and the notebook is not connected to external power, the notebook runs on battery power.

The notebook switches between AC power and battery power according to the availability of an external AC power source. For example, if the notebook contains a charged battery pack and is running on external AC power supplied through the AC adapter, the notebook will switch to battery power if the AC adapter is disconnected from the notebook.

You can leave a battery pack in the notebook or in storage, depending on how you work. Keeping a battery pack in the notebook enables the battery pack to charge whenever the notebook is connected to external AC power and also protects your work in case of a power outage.

On the other hand, battery packs in the notebook slowly discharge when the notebook is turned off and not connected to external power. For this reason, the primary battery pack is not shipped inside the notebook and must be inserted before the notebook can run on battery power.

If the notebook will be unused and not connected to external power for 2 weeks or more, remove the battery pack and store it as described in “[Storing a Battery Pack](#)” to prolong its life. For more information about leaving your work, refer to the “Power” chapter in the *Software Guide* on the *Documentation Library CD*.



Only compatible AC adapters and battery packs should be used with the notebook. For additional information, visit the HP Web site at <http://www.hp.com> or refer to the *Worldwide Telephone Numbers* booklet included with your notebook to contact an HP Customer Care Center.

This notebook supports up to 2 lithium ion battery packs: the primary battery pack and an optional travel battery pack. The same type of battery pack can be used in the notebook battery bay and in the optional travel battery caddy.

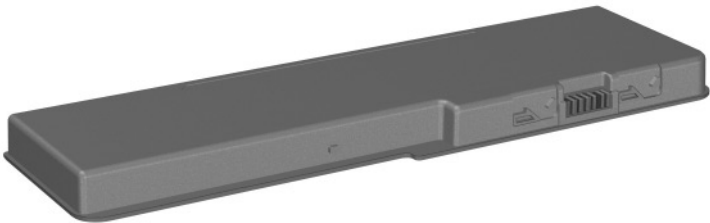

Battery pack

Inserting or Removing the Primary Battery Pack

The notebook battery bay holds the primary battery pack.

To insert the primary battery pack:

1. Turn the notebook upside-down.
2. Align the battery pack with the notebook battery bay.
3. Insert the battery pack tabs into the battery bay recesses.

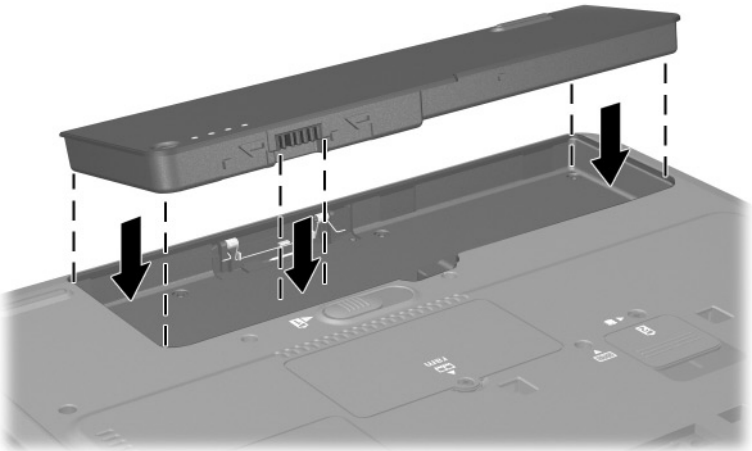

Inserting the battery pack tabs into the battery bay recesses

4. Snap the battery pack into place.

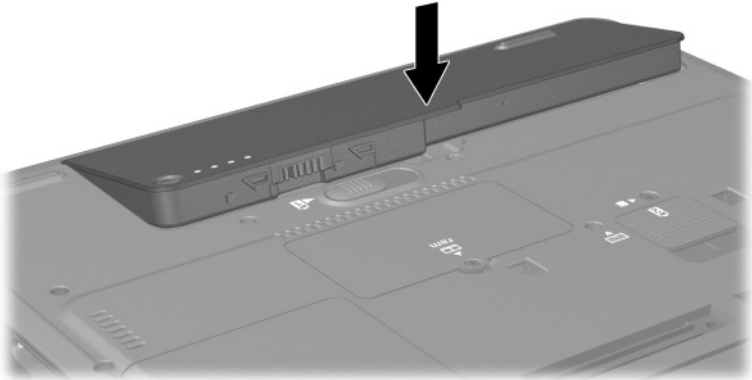

Inserting the primary battery pack

5. Turn the notebook right-side up and open the display. If the notebook is in Hibernation, press the power button to resume operation.

To remove the primary battery pack:



CAUTION: To prevent loss of work when removing a battery pack that is the sole power source, initiate Hibernation or turn off the notebook before removing the battery pack.

1. Close the display and turn the notebook upside down.
2. Slide the battery release latch **1** in the direction shown. The battery pack tilts upward.
3. Remove the battery pack from the battery bay **2**.

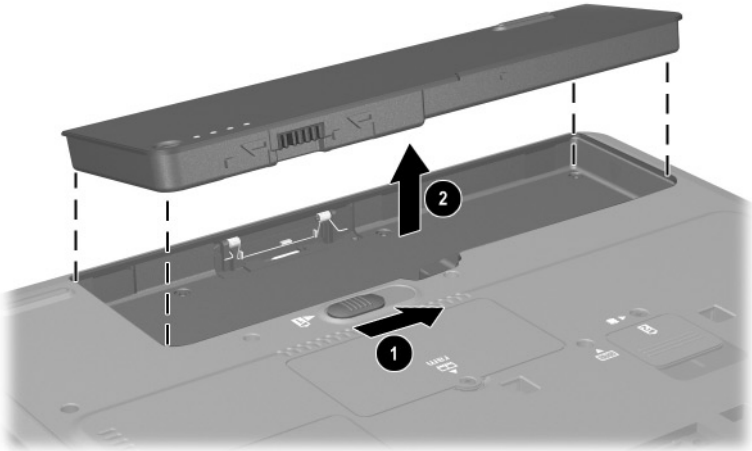

Removing the primary battery pack

Using the Optional Travel Battery Pack

The optional travel battery pack attaches to the bottom of the notebook. The optional travel battery kit includes the following items:

- Travel battery caddy
- Battery pack
- Documentation

Inserting or Removing the Battery Pack

To insert the battery pack into the travel battery caddy:

1. Align the battery pack with the travel battery caddy.
2. Insert the battery pack tabs into the travel battery caddy recesses.

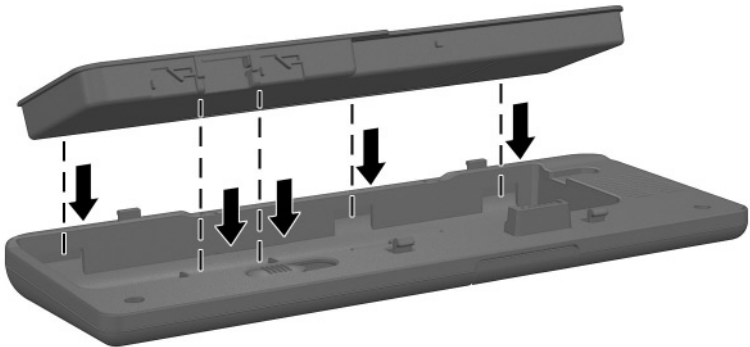

Inserting the battery pack tabs into the travel battery caddy recesses

3. Snap the battery pack into place.

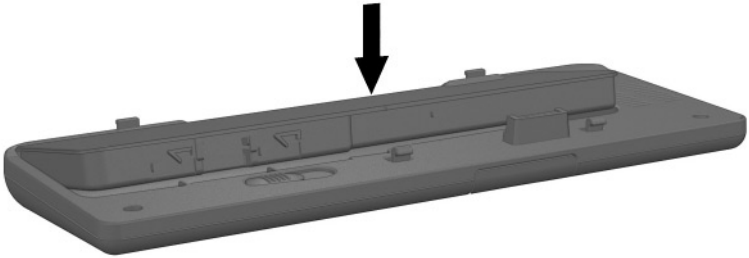

Inserting the battery pack into the travel battery caddy

To remove the battery pack from the travel battery caddy:

1. Eject the battery pack from the travel battery caddy by sliding the battery release latch **1** in the direction shown. The battery pack tilts upward.
2. Remove the battery pack from the travel battery caddy **2**.

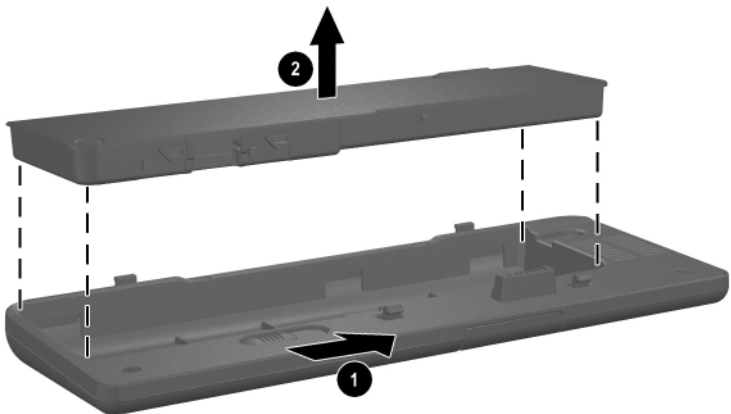

Removing a battery pack from the travel battery caddy

Attaching or Detaching the Travel Battery Pack

To attach the optional travel battery pack to the notebook:

1. Open the travel battery connector on the bottom of the notebook by sliding the cover toward the rear panel of the notebook.

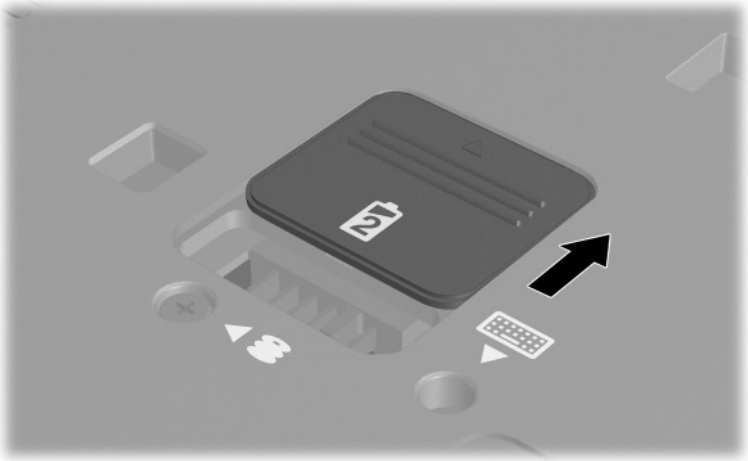

Opening the optional travel battery connector

2. Insert the tabs on the travel battery caddy into the recesses on the bottom of the notebook.

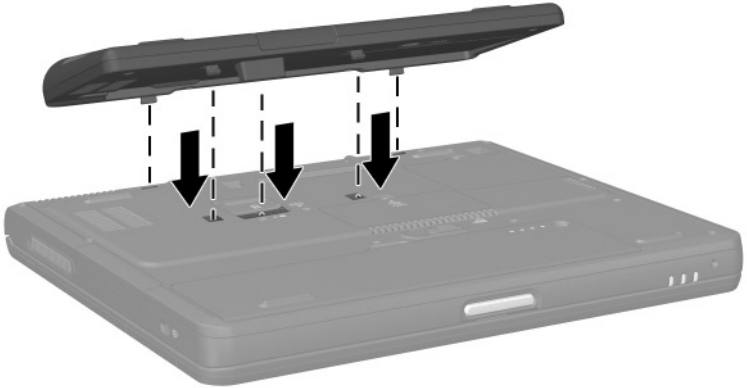

Inserting the travel battery caddy tabs into the notebook recesses

3. Press the travel battery caddy onto the notebook until it snaps into place.

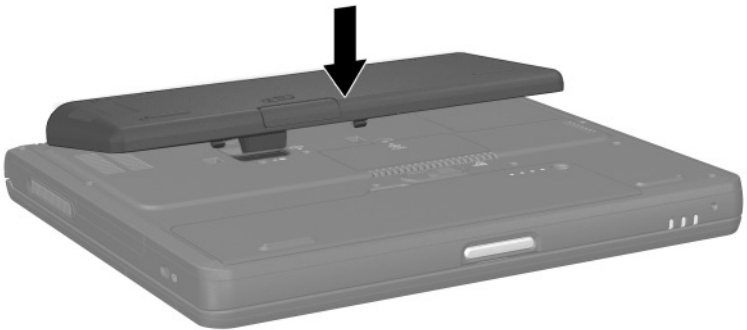

Attaching the optional travel battery caddy

4. Lock the travel battery caddy onto the notebook by sliding the locking switch in the direction shown.



Locking the optional travel battery caddy onto the notebook

To detach an optional travel battery pack from the notebook:

1. Unlock the travel battery caddy from the notebook by sliding the locking switch ❶ in the direction shown.
2. Press the release latch ❷.
3. Lift the travel battery caddy up and away from the notebook ❸.

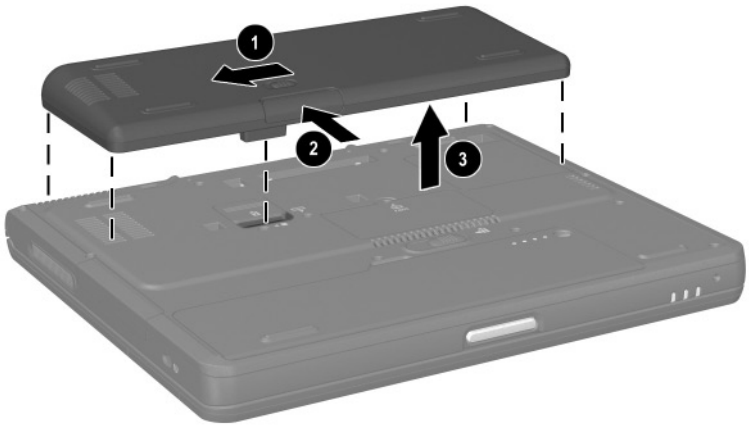

Detaching the travel battery caddy from the notebook

Charging a Battery Pack

Multiple battery packs in the system charge and discharge in a preset sequence:

- Charge sequence:
 1. Primary battery pack
 2. Travel battery pack
- Discharge sequence:
 1. Travel battery pack
 2. Primary battery pack

The primary battery pack charges when it is inside the battery bay and the notebook is connected to external power. External power can be supplied through an AC adapter, an optional Port Replicator, an optional Advanced Port Replicator, or an optional Automobile Power Adapter/Charger.

The battery pack in the travel battery caddy charges when it is attached to the notebook and the notebook is connected to external power. External power can be supplied through an AC adapter or an optional Automobile Power Adapter/Charger. Because the travel battery pack covers the docking connector, the travel battery pack cannot be used or charged while a Port Replicator or an Advanced Port Replicator is in use.

Battery packs can also be charged in the optional Universal Charger. The optional Aircraft Power Adapter can be used to run the notebook, but it cannot be used to charge a battery pack.

While the battery pack is charging, the battery light on the notebook is on. The light turns off when the battery pack is fully charged.

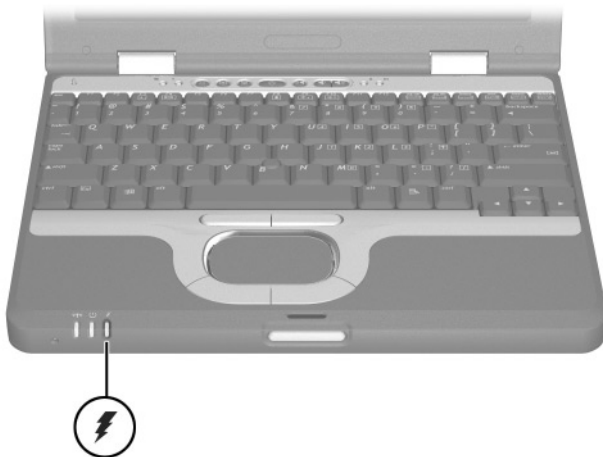

Battery light

To charge the primary battery pack:

1. Insert the battery pack into the notebook.
2. Connect the notebook to AC power. (The battery light turns on.)
3. Leave the notebook connected to AC power until the battery light turns off, signaling that the battery pack is fully charged.

To charge the travel battery pack:

1. Insert the battery pack into the travel battery caddy.
2. Attach the travel battery caddy to the notebook.
3. Connect the notebook to AC power. (The battery light turns on.)
4. Leave the notebook connected to AC power until the battery light turns off, signaling that the battery pack is fully charged.

Monitoring the Charge of a Battery Pack

This section explains several ways you can determine the amount of charge in your battery pack.

Obtaining Accurate Charge Information

To increase the accuracy of all battery charge displays:

- Allow a battery pack to discharge to less than 5 percent of a full charge through normal use before charging it.
- When you charge a battery pack, charge it fully.
- If a battery pack has been unused for one month or more, calibrate the battery pack instead of simply charging it. For calibration instructions, refer to [“Calibrating a Battery Pack.”](#)

Displaying Charge Information on the Screen

This section explains how to access and interpret battery charge information on the screen.

Accessing Charge Information

To access information about the status of any battery pack in the notebook, do one of the following:

- Select the Power icon on the taskbar.
- Press **Fn+F8**.
- Access the Power Meter tab:
 - ❑ **In Windows XP**, select Start > Control Panel > Performance and Maintenance > Power Options icon > Power Meter tab.
 - ❑ **In Windows 2000**, select Start > Settings > Control Panel > Power Options icon > Power Meter tab.

Interpreting Charge Information

Most charge information reports battery status as both a percentage and the number of minutes of charge remaining.

- The percent indicates the amount of charge remaining in the battery pack.
- The time indicates the approximate running time remaining on the battery pack *if the battery pack continues to provide power at the current level*. For example, the time remaining will decrease if you start playing a DVD and will increase if you stop playing a DVD.

Most charge displays identify battery packs by location:

- Location 1 is the notebook battery bay.
- Location 2 is the optional travel battery caddy.

In some charge information, a lightning bolt icon might be displayed beside a battery pack location. The icon indicates that the battery pack in that location is charging.

Displaying Charge Information on a Battery Pack

The battery Quick Check feature enables you to check the battery pack charge information without having to turn on the notebook. You do not have to remove a battery pack from the notebook battery bay or from the travel battery caddy to check the charge information. However, you must detach the travel battery caddy from the notebook to check the charge of the travel battery pack.

To display the percentage of a full charge remaining on a battery pack, press the Quick Check button ❶ on the battery pack. The Quick Check lights ❷ on the battery pack indicate the charge remaining, as shown in the following table.

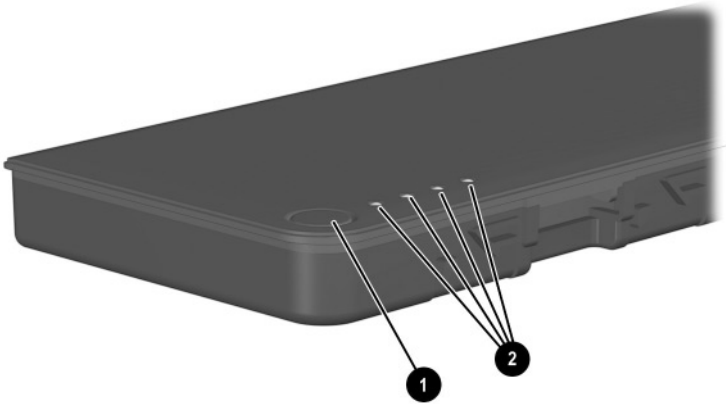

Battery pack Quick Check button and lights

Indication	Percent of a Full Charge Remaining
4 lights on	76% to 100%
3 lights on	51% to 75%
2 lights on	26% to 50%
1 light on	11% to 25%
1 light blinking	1% to 10%

Managing Low-Battery Conditions

Some low-battery condition alerts and system responses can be changed in the Power Options window of the operating system. The information in this section describes the alerts and system responses set at the factory. Preferences set in the Power Options window do not affect lights.

Identifying Low-Battery Conditions

This section explains how to identify low-battery and critical low-battery conditions.

Low-Battery Condition

When a battery pack that is the only power source available reaches a low-battery condition, the battery light blinks.

Critical Low-Battery Condition

If a low-battery condition is not resolved, the notebook enters a critical low-battery condition. In a critical low-battery condition:

- If Hibernation is enabled and the notebook is on or in Standby, the notebook initiates Hibernation.
- If Hibernation is disabled and the notebook is on or in Standby, the notebook remains in Standby until there is no power, then shuts down and loses your unsaved work.

To verify that Hibernation is enabled, be sure that the Enable Hibernate Support check box on the Hibernate tab is selected. To access the tab:

- **In Windows XP**, select Start > Control Panel > Performance and Maintenance > Power Options icon.
- **In Windows 2000**, select Start > Settings > Control Panel > Power Options icon.

Resolving Low-Battery Conditions



CAUTION: If the notebook has reached a critical low-battery condition and has initiated Hibernation, do not press the power button until Hibernation is complete. Hibernation is complete when the power light turns off.

When External Power Is Available

To resolve a low-battery condition when external power is available, select one of the following options:

- Connect the AC adapter.
- Plug an optional Automobile Power Adapter/Charger into the notebook and into a vehicle cigarette lighter receptacle.

- Plug an optional Aircraft Power Adapter into the notebook and into the in-seat power supply available on some commercial aircraft. (The optional Aircraft Power Adapter can run the notebook but cannot charge a battery pack.)
- Dock the notebook in an optional Port Replicator.

When a Charged Battery Pack Is Available

To resolve a low-battery condition when a charged battery pack is available, turn off the notebook or initiate Hibernation, insert a charged battery pack, and then turn on the notebook.

When No Power Source Is Available

To resolve a low-battery condition when no power source is available, initiate Hibernation, or save your work and shut down the notebook.

When the Notebook Cannot Exit Hibernation

To resolve a low-battery condition if the notebook lacks the power to exit Hibernation:

1. Insert a charged battery pack or connect external power.
2. Exit Hibernation by briefly pressing the power button.

Calibrating a Battery Pack

To calibrate a battery pack manually, follow the instructions in the following sections. To initiate an unattended calibration in an optional Universal Charger, follow the instructions included with the charger.

When to Calibrate

Even if a battery pack is heavily used, it should not be necessary to calibrate it more than once a month. It is not necessary to calibrate a new battery pack before first use. Calibrate the battery pack under the following conditions:

- When battery charge displays seem inaccurate.
- When you observe a significant change in battery run time.
- When the battery pack has been unused for 1 month or more.

How to Calibrate

To calibrate a battery pack, you must fully charge, fully discharge, then fully recharge the battery pack.

Charging the Battery Pack

A battery pack can charge whether the notebook is off or in use, but it will charge faster when the notebook is off.

To charge the battery pack:

1. Insert the battery pack into the notebook.
2. Connect the notebook to an AC outlet or an optional Automobile Power Adapter/Charger. The battery light on the notebook turns on.
3. Leave the notebook connected to external power until the battery pack is fully charged. The battery light on the notebook turns off.

Discharging the Battery Pack

Before you begin a full discharge, disable Hibernation. To disable Hibernation:

1. Open the Power Options window:
 - ❑ **In Windows XP**, select Start > Control Panel > Performance and Maintenance > Power Options > Hibernate tab.
 - ❑ **In Windows 2000**, select Start > Settings > Control Panel > Power Options > Hibernate tab.
2. Clear the Enable Hibernation check box.

The notebook must remain on while the battery pack is being discharged. The battery pack can discharge whether or not you are using the notebook, but it will discharge faster while the notebook is in use.

- If you plan to leave the notebook unattended during the discharge, save your work before beginning the discharge procedure.
- If you use the notebook occasionally during the discharge procedure and have set energy-saving timeouts, expect the following performance from your system during the discharge process:
 - ❑ The monitor will not turn off automatically.
 - ❑ Hard drive speed will not decrease automatically while the notebook is idle.
 - ❑ System-initiated Standby will not occur.

To fully discharge a battery pack:

1. Select the Power icon on the taskbar, or access the Power Schemes tab:
 - ❑ **In Windows XP**, select Start > Control Panel > Performance and Maintenance > Power Options icon > Power Schemes tab.
 - ❑ **In Windows 2000**, select Start > Settings > Control Panel > Power Management icon > Power Schemes tab.
2. Make a note of the 2 settings in the Plugged In column and the 2 settings in the Running on Batteries column so that you can reset them after the calibration.
3. Use the drop-down lists to set the 4 options (2 in each column) to Never.
4. Select the OK button.
5. Disconnect the notebook from the external power source, but do not turn off the notebook.
6. Run the notebook on battery power until the battery pack is fully discharged. The battery light begins to blink when the battery pack has discharged to a low-battery condition. When the battery pack is fully discharged, the battery light turns off and the notebook shuts down.

Recharging the Battery Pack

1. Connect the notebook to external power and maintain the connection until the battery pack is fully recharged. The battery light on the notebook turns off.

You can use the notebook while the battery pack is recharging but the battery pack will charge faster if the notebook is off.
2. If the notebook is off, turn it on after the battery pack is fully charged and the battery light turns off.

3. Access the Power Schemes tab:
 - ❑ **In Windows XP**, select Start > Control Panel > Performance and Maintenance > Power Options icon > Power Schemes tab.
 - ❑ **In Windows 2000**, select Start > Settings > Control Panel > Power Management icon > Power Schemes tab.
4. Refer to the settings you recorded earlier. Re-enter the settings that you recorded for the items in the Plugged In column and the Running on Batteries column.
5. Click the OK button.



CAUTION: After calibrating the battery pack, re-enable Hibernation. Failure to re-enable Hibernation can result in a complete battery drain and potential data loss.

To re-enable Hibernation:

- **In Windows XP**, select Start > Control Panel > Performance and Maintenance > Power Options icon > Hibernate tab. Select the Enable Hibernation check box.
 - **In Windows 2000**, select Start > Settings > Control Panel > Power Options > Hibernate tab. Select the Enable Hibernation check box.
-

Conserving Battery Power

Using the following battery conservation procedures and settings extends the time that a battery pack can run the notebook from a single charge.

Conserving Power as You Work

To conserve power as you use the notebook:

- Turn off wireless and LAN connections and exit modem applications when you are not using them.
- Disconnect external devices you are not using that are not connected to an external power source.

- Stop or remove a PC Card or SD Memory Card that you are not using.
- Use the **Fn+F9** and **Fn+F10** hotkeys to quickly lower and raise screen brightness as you need it.
- Use optional powered speakers instead of the internal speakers, or use the volume buttons to quickly raise and lower system volume as needed.
- Turn off a device connected to the S-Video connector by using the **Fn+F4** hotkey or by turning off support for the device in Windows.
- Run the notebook on external power while formatting a diskette.
- If the notebook will be idle for several minutes, initiate Standby or Hibernation or shut down the notebook.

Selecting Power Conservation Settings

To set the notebook to conserve power:

- Select a short wait for the screen saver and select a screen saver with minimal graphics and motion. To access screen saver settings:
 - **In Windows XP**, select Start > Control Panel > Appearance and Themes > Display icon > Screen Saver tab.
 - **In Windows 2000**, select Start > Settings > Control Panel > Display > Screen Saver tab.
- Select a Power Scheme with low-power-use settings through the operating system. Refer to the “Power” chapter in the *Software Guide* on the *Documentation Library* CD.
- Select Battery Optimized or Maximum Battery Mode in Intel® SpeedStep (Windows 2000 only). Refer to the “Power” chapter in the *Software Guide* on the *Documentation Library* CD.

Storing a Battery Pack

If a notebook will be unused and not connected to external power for 2 weeks or more, remove and store the battery pack.



CAUTION: To prevent damage to a battery pack, do not expose it to high temperatures for an extended time.

High temperatures accelerate the self-discharge rate of a stored battery pack. To prolong the charge of a stored battery pack, place it in a cool, dry place.

Use the following table to estimate how long you can safely store a battery pack. The storage times provided are based on a battery pack that contains 50 percent of a full charge. A fully charged battery pack can be safely stored for longer times; a battery pack containing a lower charge can be safely stored for less time.

Calibrate a battery pack that has been stored for 1 month or more before using it.

Temperature Range (°F)	Temperature Range (°C)	Safe Storage Time
115° to 140°	46° to 60°	Less than 1 month
79° to 113°	26° to 45°	No more than 3 months
32° to 77°	0° to 25°	1 year

Disposing of a Used Battery Pack



WARNING: There is a risk of fire and chemical burn if a battery pack is handled improperly. Do not disassemble, crush, or puncture a battery pack, or short the contacts on it. Do not expose a battery pack to temperatures higher than 60°C (140°F) or dispose of a battery pack in water or fire.

When a battery pack has reached the end of its useful life, do not dispose of it in general household waste.

- In Europe, dispose of or recycle battery packs by using the public collection system or by returning them to HP, your authorized HP partners, or their agents.
- In other regions, refer to the *Worldwide Telephone Numbers* booklet included with the notebook to contact an HP Customer Care Center and request information about battery pack disposal.

For more information about battery pack precautions and disposal, and the complete text of governmental agency notices, refer to the *Regulatory and Safety Notices* guide on the *Documentation Library CD*.

Finding More Power Information

For more information about using Standby and Hibernation, conserving power, setting power preferences, and using other power management features, refer to the “Power” chapter in the *Software Guide* on the *Documentation Library CD*.

Hard Drive

Caring for Drives

Drives are fragile notebook components that must be handled with care. The following cautions apply to all drives. Additional cautions are included in the procedures to which they apply.



CAUTION: To prevent loss or damage to the notebook or a drive:

- Handle a drive carefully. Do not drop it.
 - Excessive force can damage drive connectors. When you insert a drive, use only enough force to seat the drive.
 - Do not spray a drive with cleaning fluid or other liquid or expose it to temperature extremes.
 - Do not remove the primary hard drive (the hard drive in the hard drive bay) except for repair or replacement.
 - Electrostatic discharge can damage electronic components. To prevent electrostatic damage to the notebook or a drive:
 - Before handling a drive, discharge yourself from static electricity by touching a grounded metal object.
 - Avoid touching the connectors on a drive.
 - Refer to the *Regulatory and Safety Notices* on the *Documentation Library CD*.
 - Avoid exposing a drive or a diskette to devices with magnetic fields. Security devices with magnetic fields include airport walk-through devices and security wands. The airport security devices that check carry-on luggage, usually while it is placed on a conveyor belt, use x-rays instead of magnetism and will not damage a drive or a diskette.
 - If you mail a drive, ship it in packaging that protects it from shock, vibration, temperature, and high humidity. Label the package "FRAGILE."
-

Hard Drive

This section discusses the primary hard drive of the notebook.

Identifying the Hard Drive Activity Light

The hard drive activity light turns on when the hard drive is being accessed.



Hard drive activity light

Replacing the Primary Hard Drive

The hard drive in the hard drive bay is the primary hard drive.

To replace the primary hard drive:

1. Save your work, exit all applications, and shut down the notebook. If you are not sure whether the notebook is off or in Hibernation, briefly press the power button. If your work returns to the screen, save your work, exit all applications, and then shut down the notebook.
2. Disconnect all external devices connected to the notebook.
3. Disconnect the power cord and remove any battery packs.
4. Close the display and turn the notebook upside down.
5. Remove the hard drive retaining screw.

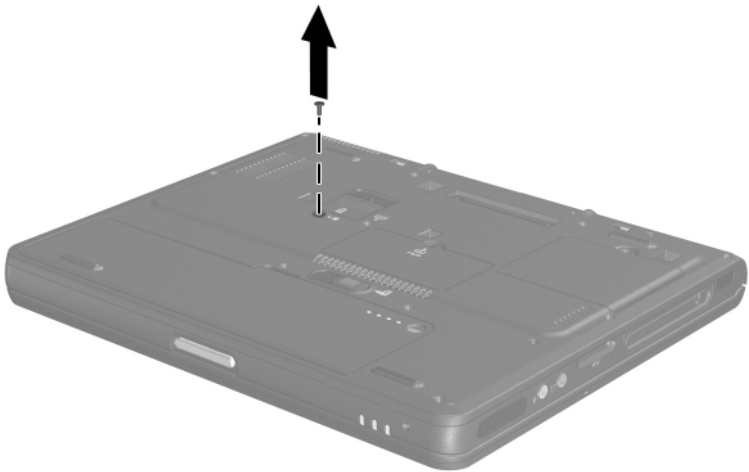

Removing the hard drive retaining screw

6. Slide the bottom half of the front bezel upward to create a handle.

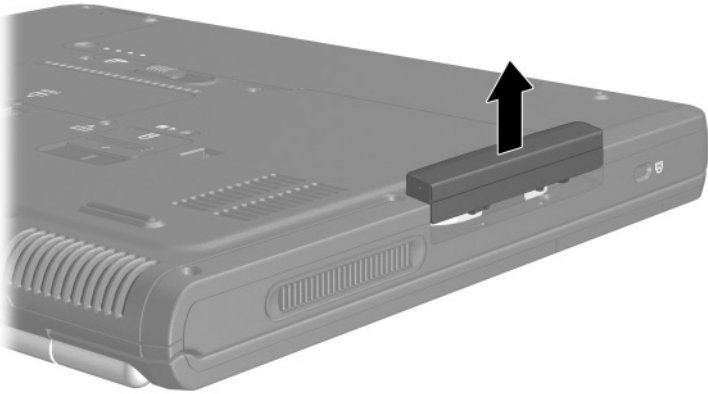

Extending the front bezel to create a handle

7. Pull the drive out of the bay.

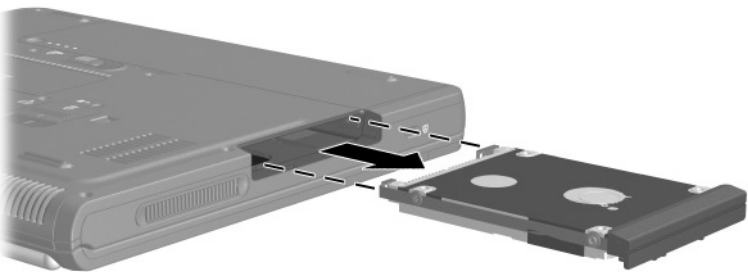

Removing the hard drive from the hard drive bay

8. Insert a hard drive by sliding the hard drive into the bay until the drive is seated.



Inserting the hard drive into the hard drive bay

9. Close the front bezel of the hard drive.

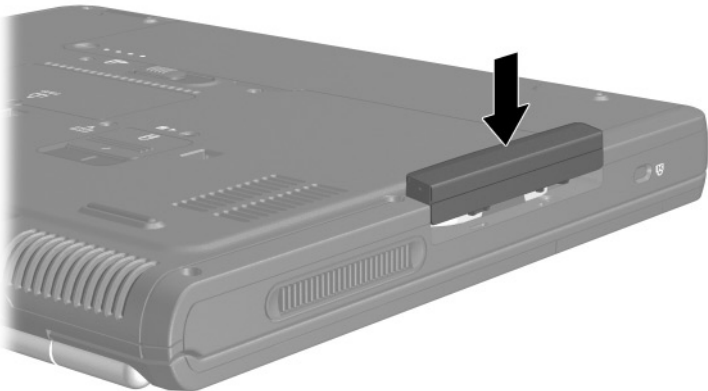

Closing the hard drive bezel

10. Reinsert the hard drive retaining screw. (If you removed a hard drive but did not replace it, put the retaining screw in a safe place.)

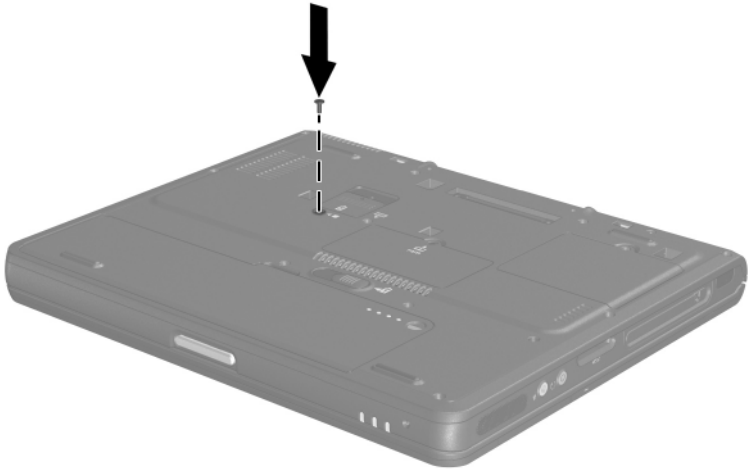

Replacing the hard drive retaining screw

Audio and Video

Using Audio Features

The notebook includes the audio components described in the following table.

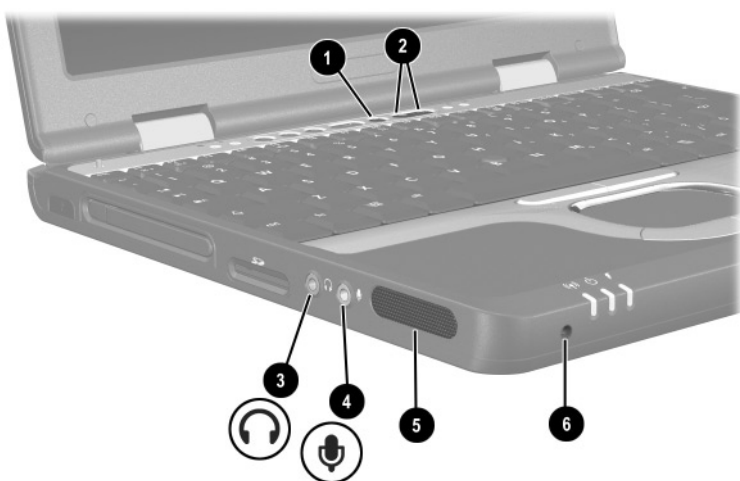

Audio components

Component	Description
❶ Mute button	Mutes system volume.
❷ Volume buttons	Adjust the system volume.

(continued)

Component	Description
③ Audio line-out jack	Connects optional, powered stereo speakers, headphones, headset, or television audio.
④ Microphone input jack	Connects an optional monaural microphone.
⑤ Speaker	Produces system sound.
⑥ Microphone	Inputs single-channel sound.

Using the Audio Line-Out Jack



WARNING: To reduce the risk of personal injury, adjust the volume before putting on headphones or a headset.



CAUTION: To prevent possible damage to an external device, do not plug a single-sound channel (monaural) connector into the audio line-out jack.

The audio line-out jack is also used to connect the audio function of an audio/video device such as a television or VCR.

When connecting a device to the audio line-out jack:

- Use only a 3.5-mm stereo plug.
- For best sound quality, use 24-ohm to 32-ohm headphones.



The internal speakers are disabled when a device is connected to the audio line-out jack.

Using the Microphone Input Jack

When an external microphone is connected to the notebook, the notebook microphone is disabled.

When connecting a microphone to the microphone input jack, use a monaural microphone with a 3.5-mm plug.

Adjusting the Volume

To adjust the volume, use any of the following controls:

- Notebook volume buttons
 - ❑ To mute or restore volume, press the mute button. You can also mute or restore volume by simultaneously pressing the volume up and volume down buttons.
 - ❑ To decrease the volume, press the volume down button.
 - ❑ To increase the volume, press the volume up button.
- Windows Volume Control
 - ❑ **In Windows XP:**
 - a. Select Start > Control Panel > Sounds, Speech and Audio Devices > Sounds and Audio Devices.
 - b. Select the Volume tab.
 - c. Select the check box for Place Volume Icon in the Taskbar.
 - d. Select the OK button.
 - ❑ **In Windows 2000:** the Windows Volume Control icon is displayed on the taskbar.



Volume can also be adjusted within some applications.

Using Video Features

The notebook features an S-Video-out jack which connects the notebook to an optional S-Video device, such as a television or overhead projector.

The notebook can support one S-video device connected to the S-video out jack while simultaneously supporting an image on the notebook display or an external display attached to the external monitor connector. The S-video-out connection usually provides a higher quality image than a composite-video connection.

To transmit video signals through the S-Video-out jack, you need an S-Video cable, available from most electronics retailers. If you are combining audio and video functions, such as playing a movie from a DVD in an optional External MultiBay drive to a television, you also need a standard audio cable, available from most electronics retailers. Connect the audio cable to the external device and to the audio line-out jack.

Using the S-Video-Out Jack

To connect a video device to the S-Video-out jack:

1. Plug either end of the S-Video cable **1** into the S-Video-out jack on the notebook.
2. Connect the other end of the cable **2** to the video device as instructed in the documentation included with the device.

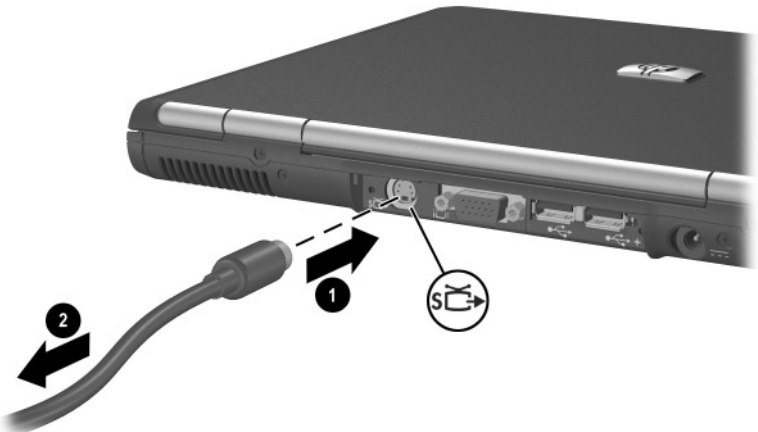

Connecting a device to the S-Video-out jack



If the S-Video-out jack on the notebook is not accessible while the notebook is docked, you can connect the device to the S-Video-out jack on the optional Port Replicator.

Changing the Video Mode

The default color television standard mode of the notebook is NTSC. Color television standard modes vary even within regions. However, NTSC is common in North America; PAL is common in Europe, China, Africa, and the Middle East; NTSC-J is common in Japan; and PAL-M is common in Brazil. Other South and Central American regions may use NTSC, PAL, or PAL-M.

To change the color television standard mode from NTSC:

1. Access the ATI Display tab:
 - ❑ **In Windows XP**, select Start > Control Panel. Double-click the Display icon. Select the Settings tab, select the Advanced button, and then select the ATI Displays tab.
 - ❑ **In Windows 2000**, select Start > Settings > Control Panel. Double-click the Display icon, select the Settings tab, select the Advanced button, and then select the ATI Displays tab.
2. Enable the TV by selecting the Enable button, indicated by a red triangle.
3. Select the TV Header, and then select the Format tab.
4. Select a television format either by name or by Country/Region:
 - ❑ To select a format by name, select Format, select a format in the drop-down list, and then select OK.
 - ❑ To select the default format for a region or country, select Country/Region, select a location in the drop-down list, and then select OK.
5. Select the Close button to close all opened dialog boxes.
6. At the prompt, restart the notebook.

Communication Devices

Connecting a Modem Cable

A modem cable, which has a 6-pin RJ-11 connector at each end, must be connected to an analog telephone line with, in some countries, the use of a country-specific modem adapter. Modem cables are provided with most notebooks, but they may also be purchased separately from most electronics retailers. Some notebooks may have been purchased without an internal modem.



WARNING: Connecting the notebook to a digital line can permanently damage the modem. Immediately disconnect your modem cable if it is accidentally connected to a digital line.



CAUTION: Jacks for digital PBX systems might resemble analog telephone jacks but are not compatible with the modem.



CAUTION: Built-in modems may not work with multiple phone lines or a private branch exchange (PBX). They cannot be connected to a coin-operated telephone, and they do not work with party lines. Some of these connections may result in excess electrical voltage and could cause a malfunction in the internal modem. Check your telephone line type before connecting your phone line.

If the modem cable contains noise suppression circuitry, which prevents interference from TV and radio transmissions, orient the circuitry end of the cable toward the notebook.



RJ-11 modem cable with noise suppression circuitry

Connecting the RJ-11 Modem Cable

To connect an RJ-11 modem cable:

1. Plug the modem cable ❶ into the RJ-11 jack on the notebook.

 To reduce the risk of electrical shock, fire, or damage to the equipment, do not plug a telephone cable into the RJ-45 network jack.

2. Plug the other end of the cable ❷ into the RJ-11 telephone jack.

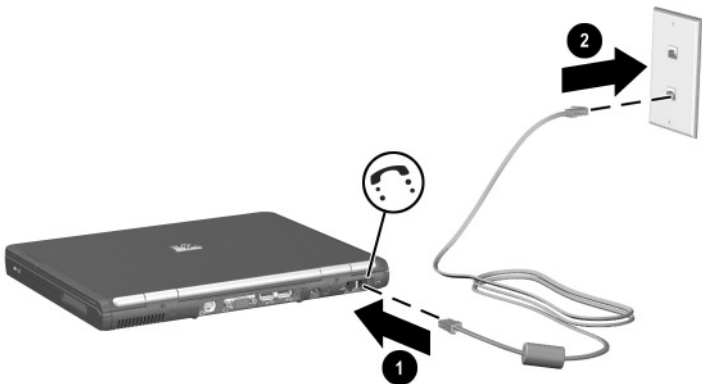

Connecting the RJ-11 modem cable

For more information about using the modem or about using AT commands and dial modifiers, refer to the *Modem and Networking* guide or the *Modem Command Guidelines (Advanced Users Only)*, provided in English on the *Documentation Library CD*.

Using a Country-Specific Adapter Cable

Telephone jacks vary by country. To use the modem and the RJ-11 cable outside the country in which you purchased the notebook, you must obtain a country-specific modem adapter. Refer to the *Modem and Networking* guide on the *Documentation Library* CD for more details about using your notebook internationally.

To connect the modem to an analog telephone line that does not have an RJ-11 telephone jack:

1. Plug the modem cable into the RJ-11 jack on the notebook ❶.

⚠ To reduce the risk of electrical shock, fire, or damage to the equipment, do not plug a telephone cable into the RJ-45 network jack.

2. Plug the modem cable ❷ into the country-specific modem adapter.
3. Plug the country-specific modem adapter ❸ into the telephone jack.

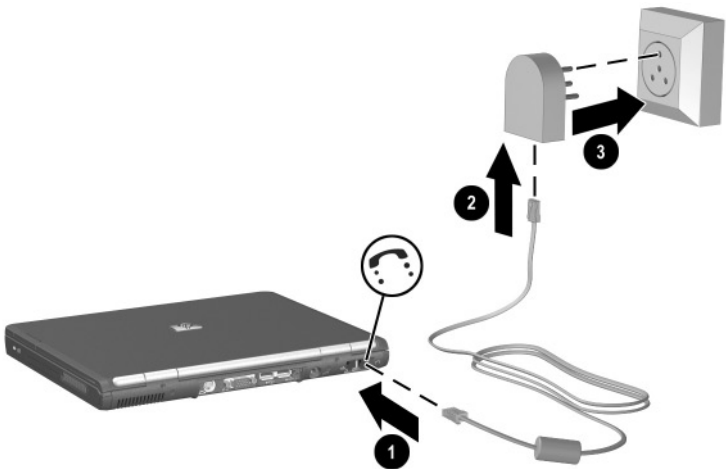

Connecting a modem cable using a modem adapter

Connecting a Network Cable

A network cable has an 8-pin RJ-45 connector at each end. A network cable is provided with most notebooks, but may also be purchased separately from most electronics retailers. If the network cable contains noise suppression circuitry, which prevents interference from TV and radio transmissions, orient the circuitry end of the cable toward the notebook.



RJ-45 network cable with noise suppression circuitry

To connect the network cable:

1. Plug the network cable ❶ into the RJ-45 jack on the notebook.
2. Plug the other end of the cable ❷ into a network jack.

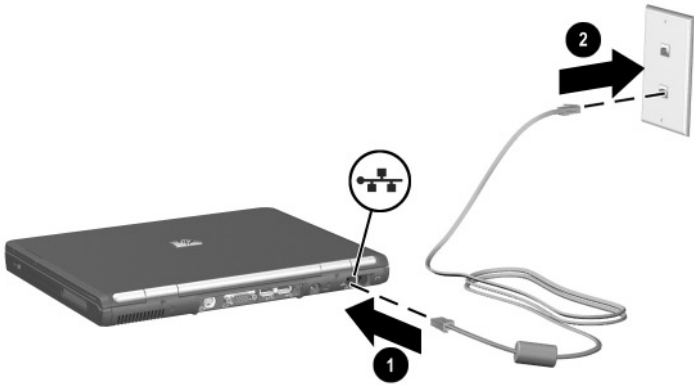

Connecting a network cable

3. Start or restart the notebook.



See Windows Help for information about setting up and using LAN connections. Select Start > Help and Support. Contact your network administrator for network information.

Linking to an Infrared Device

The notebook is IrDA-compliant—4-Mbps standard—and can communicate with another infrared-equipped device that is also IrDA compliant.

The infrared port supports both low-speed connections of up to 115 Kbps and high-speed connections of up to 4 Mbps. Infrared performance may vary depending on the performance of infrared peripherals, distance between infrared devices, and applications used.

Infrared signals are sent through an invisible beam of infrared light and require an unobstructed line-of-sight path.



Linking to an infrared device

Setting Up an Infrared Transmission

For information about using infrared software, refer to your operating system Help file.

To set up infrared devices for optimal transmission:

- Prepare the infrared ports on both devices for transmission.
- Position the devices so that their infrared ports face one another at a distance no greater than 1 meter (3.3 feet).
- Position the ports so that they face one another directly. Because the maximum capture angle is 30 degrees, the ports must be aligned no more than 15 degrees off-center.
- Shield the ports from direct sunlight, flashing incandescent light, and energy-saving fluorescent light.
- Be sure that no signals from remote control or other wireless devices, such as headphones or audio devices, aim at a port.
- During the transmission, do not move either device and do not allow objects or movement to disrupt the beam.

Avoiding Standby with Infrared

Standby is not compatible with infrared transmission. If the notebook is in Standby, an infrared transmission cannot be initiated. If Standby is initiated during an infrared transmission, the transmission stops. To resume from Standby, press the power button. The transmission resumes when the notebook resumes from Standby. However, any program that was using the infrared transmission when Standby was initiated may not continue at the point it was stopped. For example, if a program was printing when Standby was initiated, the program resumes transmission after the notebook resumes, but the print job may not resume.

Using Wireless LAN

The notebook provides internal wireless LAN supported through an optional Mini PCI device. For more information on using your internal wireless LAN, refer to the wireless LAN documentation included with the notebook.

Using Bluetooth

The notebook provides internal wireless Bluetooth connectivity supported through an optional integrated module. For more information on using your internal Bluetooth module, refer to the wireless Bluetooth documentation included with the notebook.

External Devices

The jacks and connectors described in this guide support standard external devices.

- For information about which jack or connector to use, refer to the documentation included with the device.
- For information about installing or loading any software, such as drivers, that are required by the device, refer to the documentation included with the device.

To connect a standard external device to the notebook:

1. Turn off the notebook.
2. If you are connecting a powered device, turn off the device.
3. Connect the device to the connector on the notebook.
4. If you are connecting a powered device, plug the device power cord into a grounded electrical outlet.
5. Turn on the device.
6. Turn on the notebook.

To disconnect a standard external device from the notebook, turn off the device, then disconnect the device from the notebook.

Connecting a Monitor or Projector

To connect an external monitor or projector to the notebook, insert the monitor cable into the external monitor connector on the back of the notebook.



If a properly connected external monitor or projector does not display an image, try pressing the **Fn+F4** hotkey to switch the image to the monitor.

Using a USB Device

Two Universal Serial Bus (USB) connectors can be used to connect external USB 2.0 and USB 1.1 devices, such as a USB keyboard, mouse, drive, printer, scanner, hub, or External MultiBay to the notebook.

The notebook has a USB connector ❶ and a USB connector that also connects an optional powered External MultiBay ❷. The USB connectors support USB 2.0 and USB 1.1 devices.

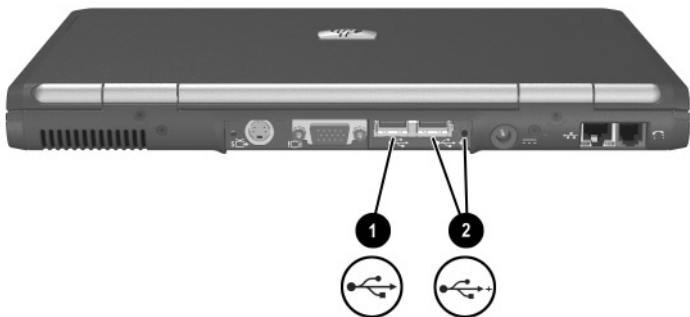

USB connectors on the rear panel

USB hubs can be connected to a USB connector on the notebook or on an optional Port Replicator or to other USB devices. Hubs support varying numbers of USB devices and are used to increase the number of USB devices in the system. Powered hubs must be connected to external power. Unpowered hubs must be connected either to a USB connector on the notebook or to a port on a powered hub.

A USB device functions in the same way as a comparable non-USB device, with one exception. By default, USB devices do not function unless an operating system that supports USB is loaded.

Some USB devices may require additional support software, which is usually included with the device. For more information and software installation instructions, refer to the documentation included with the device.

Enabling USB Legacy Support

You must enable USB legacy support to:

- Use a USB keyboard, mouse, or hub connected to a USB connector on the notebook during startup.
- Use a USB keyboard, mouse, or hub that is used in a non-Windows application or utility.
- Boot from an optional External MultiBay.

To enable USB legacy support:

1. Turn on or restart the notebook.
2. Press **F10** while the F10 = ROM Based Setup message is displayed in the lower left corner of the screen.
 - ❑ To change the language, press **F2**.
 - ❑ For navigation instructions, press **F1**.
3. Select Advanced menu > Device Options.

4. Select Enable USB legacy support.
5. To save your preference and exit Computer Setup, select File > Save Changes and Exit, and then follow the instructions on the screen.

Connecting an Optional External MultiBay

An External MultiBay connects to the notebook by way of the self-powered USB connector and enables you to use MultiBay drives. For more information about the External MultiBay, refer to the documentation that is included with the device.

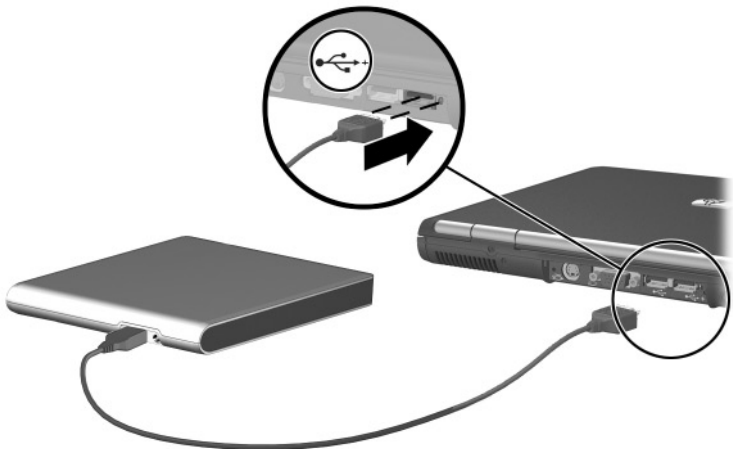

Connecting an External MultiBay

Connecting an Optional Cable Lock



The purpose of security solutions is to act as a deterrent. These solutions do not prevent the product from being mishandled or stolen.

To install a security cable:

1. Loop the security cable around a secured object.
2. Insert the cable lock key into the cable lock.
3. Insert the cable lock into the security cable slot.
4. Turn the key and remove it from the cable lock.

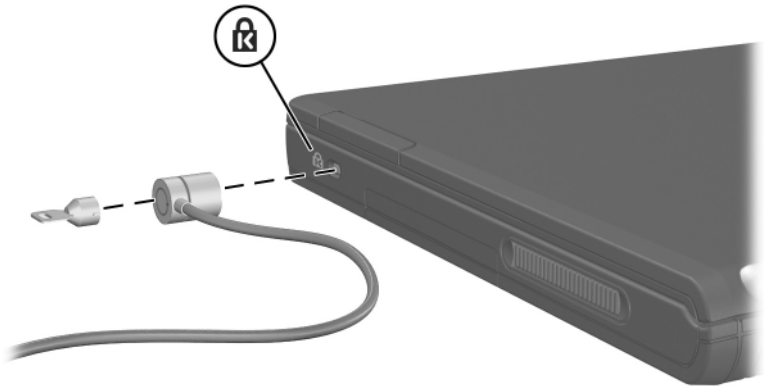

Connecting a security cable

Hardware Upgrades

To order hardware or learn more about upgrades and accessories, visit the HP Web site at <http://www.hp.com> or refer to *Worldwide Telephone Numbers* booklet included with the notebook to contact an HP Customer Care Center.

For information about obtaining and installing software updates and upgrades, refer to the “Software Updates and Restorations” chapter in the *Software Guide* on the *Documentation Library CD*.

Using Optional PC Cards

A PC Card is a credit card-sized accessory designed to conform to the standard specifications of the Personal Computer Memory Card International Association (PCMCIA).

- The notebook supports 32-bit (CardBus) and 16-bit PC Cards.
- The notebook supports one Type I card or one Type II card.
- Zoomed video PC Cards are not supported.



CAUTION: If you install all of the software or any of the enablers provided by a PC Card manufacturer, you may not be able to use other PC Cards. If you are instructed by the documentation included with your PC Card to install device drivers:

- Install only the device drivers for your operating system.
 - Do not install other software, such as card services, socket services, or enablers, that may also be supplied by the PC Card manufacturer.
-

Inserting a PC Card



CAUTION: To prevent damage to the connectors:

- Use minimal pressure when inserting a PC Card into a PC Card slot.
 - Do not move or transport the notebook while a PC Card is inserted.
-

To insert a PC Card:

1. Hold the PC Card label-side up with the connector facing the notebook.
2. Gently slide the card into the slot until the card is seated.



Inserting a PC Card into the PC Card slot

Removing a PC Card

 **CAUTION:** To prevent loss of work or system lockup, stop the PC Card, according to the instructions that follow, before removing it.

1. Stop the PC Card:
 - ❑ **In Windows XP**, select the Safely Remove Hardware icon on the taskbar, then select the PC Card. (To display the Safely Remove Hardware icon, right-click the taskbar and select Show Hidden Icons.)
 - ❑ **In Windows 2000**, select the Unplug or Eject icon on the taskbar, then select the PC Card you plan to remove. A message is displayed when the card can be safely removed.
2. Press the PC Card eject button **1**.
3. Gently pull out the card **2**.

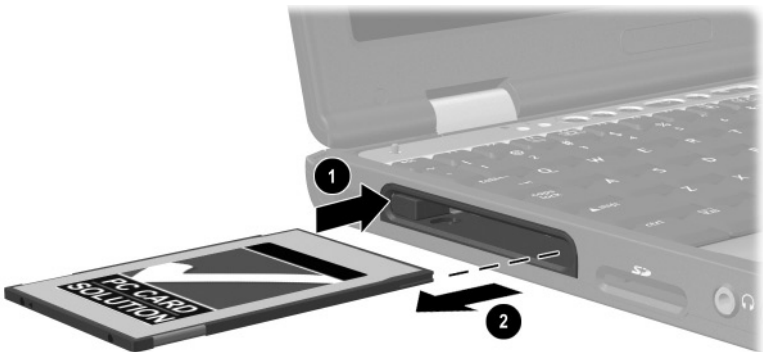

Removing a PC Card



An inserted PC Card uses power even when not in use. To conserve power, stop or remove a PC Card when you are not using it.

Using Optional SD Cards

Secure Digital (SD) Cards are removable postage stamp-sized compact flash storage devices that provide a convenient method of storing data and sharing it with other devices such as PDAs, cameras, and other notebooks and PCs that use SD Cards.



Inserting an SD Card



CAUTION: To prevent damage to the connectors:

- Use minimal pressure when inserting an SD Card into an SD Card slot.
 - Do not move or transport the notebook while an SD Card is inserted.
-

To insert an SD Card:

1. Insert the SD Card into the SD slot.
2. Slide the card firmly into the slot until the card clicks into place.

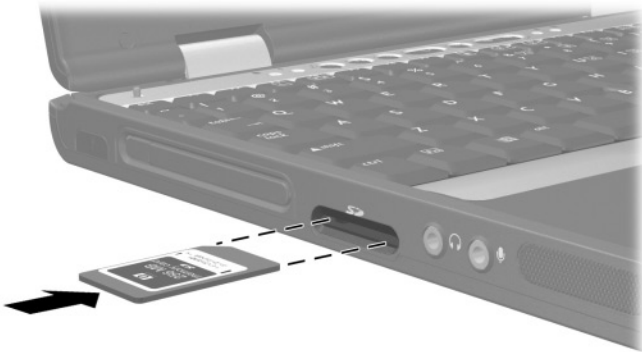

Inserting an SD Card into the SD slot

Removing an SD Card

CAUTION: To prevent loss of work or system lockup, stop the SD Card before removing it.

To remove an SD Card:

1. Close all files and applications that are using the SD Card.
2. Stop the SD Card:
 - ❑ **In Windows XP**, select the Safely Remove Hardware icon in the taskbar, then select the SD Card. (To display the Safely Remove Hardware icon, right-click the taskbar and select Show Hidden Icons.)
 - ❑ **In Windows 2000**, select the Unplug or Eject icon in the task bar, then select the SD Card you plan to remove. A message is displayed when the card can be safely removed.

CAUTION: Attempting to remove the SD Card without pressing in to unseat it first might damage the connectors in the SD Card slot.

3. Gently press in on the SD Card ❶ to release it.
4. Pull the SD Card ❷ from the slot.

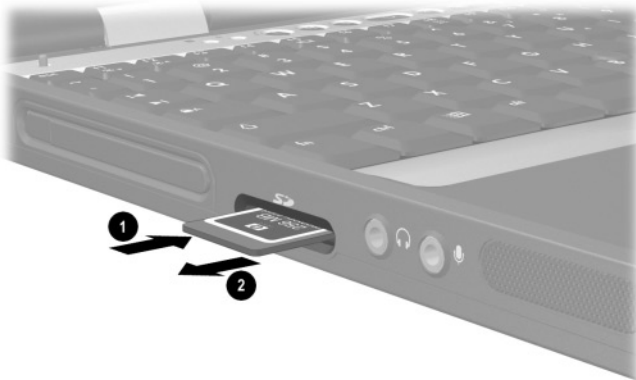

Ejecting an SD Card from the SD slot

Adding and Upgrading Memory Modules



WARNING: The memory compartments are the only user-accessible internal compartments on the notebook. All other areas that require a tool to access should be opened only by an HP authorized service provider.



WARNING: Failure to unplug the power cord and remove all battery packs before installing a memory expansion board can damage the equipment and expose you to the risk of electrical shock.



CAUTION: Electrostatic discharge (ESD) can damage electronic components. Before beginning any procedure, ensure that you are discharged of static electricity by touching a grounded metal object. For more information, refer to the *Regulatory and Safety Notices* guide on the *Documentation Library* CD.

The notebook has 2 memory slots. The primary memory slot is located under the keyboard. The primary memory slot is populated at the factory. The memory expansion slot is located on the bottom of the notebook.

The memory capacity of the notebook can be upgraded first by adding a memory module to the expansion slot and then by upgrading the memory module in the primary memory slot.

Adding a Memory Expansion Module

To add a memory expansion module:

1. Save your work, exit all applications, and shut down the notebook. If you are not sure whether the notebook is off or in Hibernation, briefly press the power button. If your work returns to the screen, save your work, exit all applications, and then shut down the notebook.
2. Disconnect all external devices connected to the notebook.

3. Disconnect the power cord.
4. Turn the notebook upside down.
5. Remove any battery packs from the notebook.
6. Remove the screw **1** from the memory expansion slot cover.
7. Tilt the expansion slot cover **2** away from the notebook.

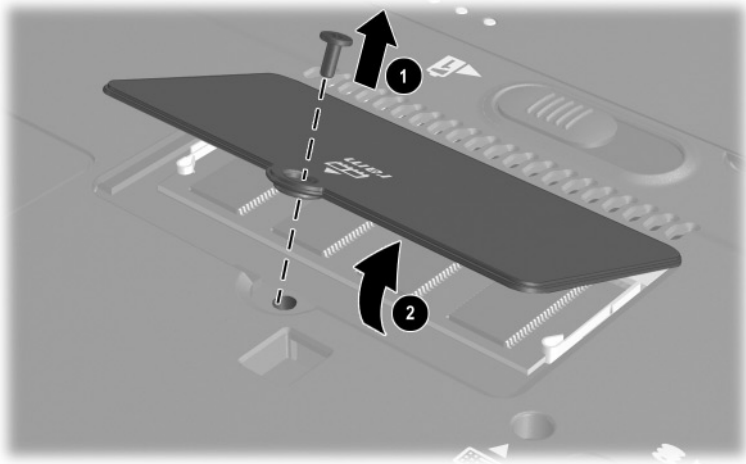

Removing the expansion slot cover

8. Remove the memory expansion slot cover.

9. Insert the memory expansion module:
 - a. Align the keyed (notched) edge of the module **1** with the keyed area in the expansion slot.
 - b. Press the module into the slot from a 45-degree angle until it is seated, then push the board downward **2** until the retention clips snap into place.

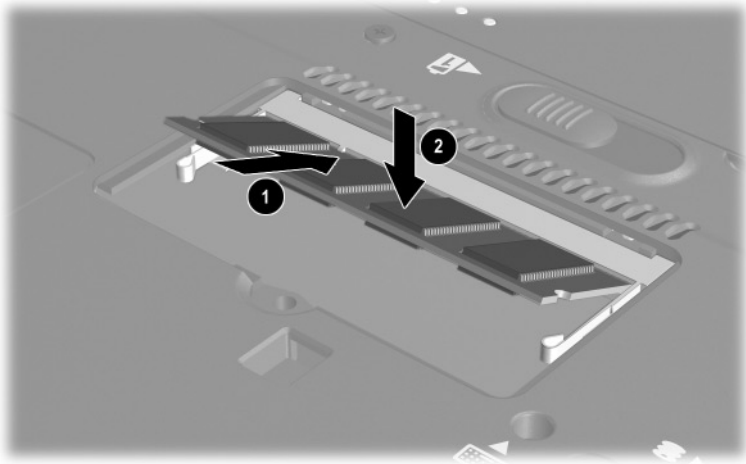

Inserting a memory expansion module

10. Insert the tabs on the expansion slot cover into the recesses in the expansion slot.
11. Replace the expansion slot cover over the expansion module compartment ❶.
12. Replace the expansion slot cover screw ❷.

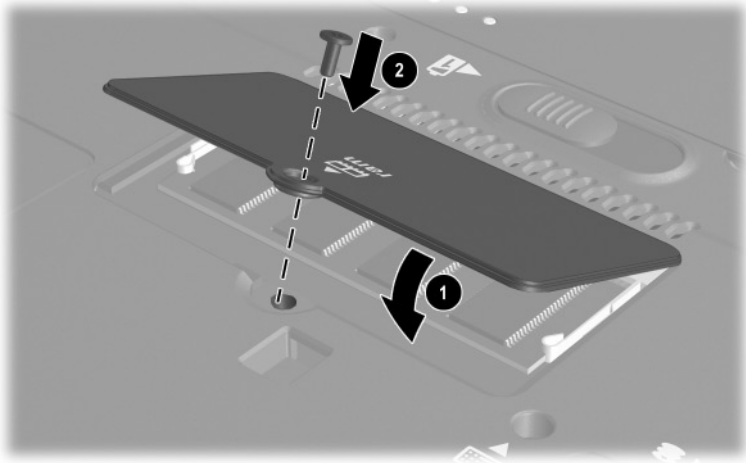

Replace the expansion slot cover

13. Replace the battery packs.
14. Reconnect AC power and external devices.
15. Restart the notebook.

Upgrading the Memory Module in the Primary Memory Slot

To upgrade the memory module in the primary memory slot:

1. Save your work, exit all applications, and shut down the notebook. If you are not sure whether the notebook is off or in Hibernation, briefly press the power button. If your work returns to the screen, save your work, exit all applications, and then shut down the notebook.
2. Disconnect all external devices connected to the notebook.
3. Disconnect the power cord.
4. Remove any battery packs from the notebook.
5. Remove the keyboard screw ❶ from the bottom of the notebook. A keyboard icon is located next to the keyboard screw.
6. Remove the two Quick Launch button bezel screws ❷.

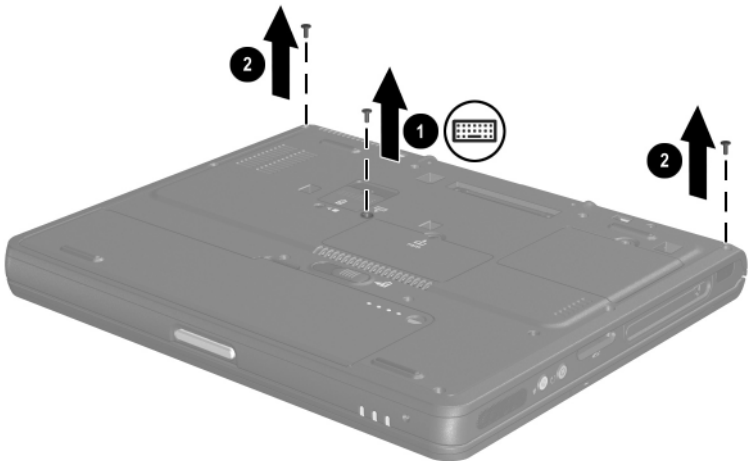

Removing the keyboard and Quick Launch button bezel screws

7. Using a fingernail or small flat tool, remove the Quick Launch button bezel located above the keyboard.

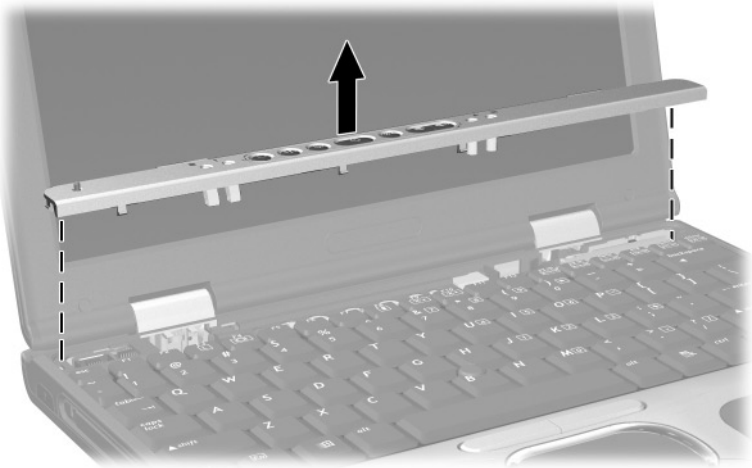

Removing the Quick Launch button bezel

8. Remove the keyboard.

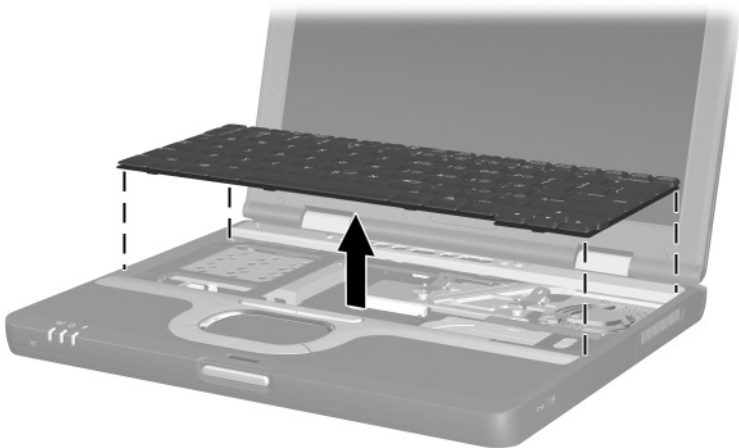

Removing the keyboard

9. Remove the existing memory module:
 - a. Pull away the retention clips ❶ on each side of the module. (The module tilts upward.)
 - b. Lift the edge of the memory expansion module, then gently pull it out of the slot ❷.

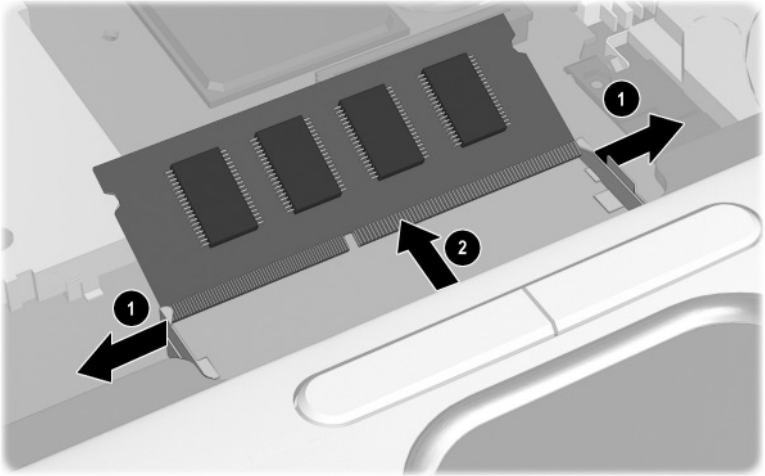

Removing the existing memory module



To protect a memory module after it has been removed, place it in a static-safe container.

10. Insert the new memory module:
 - a. Align the keyed (notched) edge of the module with the keyed area in the expansion slot.
 - b. Press the module **1** into the slot from a 45-degree angle until it is seated, then push the module **2** downward until the retention clips snap into place.

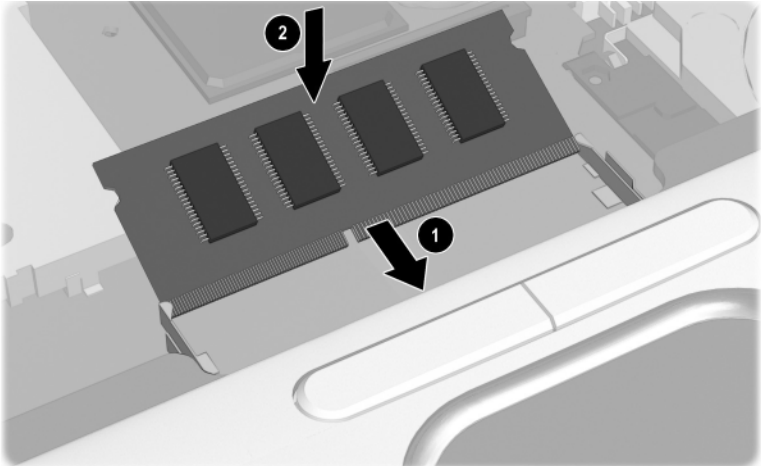

Inserting the new memory module

11. Replace the keyboard.
12. Replace the Quick Launch button bezel.
13. Replace the keyboard and Quick Launch button bezel screws located on the bottom of the notebook.
14. Replace the battery packs.
15. Reconnect external AC power and external devices.
16. Restart the notebook.

Effects of Increasing Memory

When memory increases, the operating system increases the hard drive space reserved for the Hibernation file.

If you experience problems with Hibernation after memory has been increased, verify that your hard drive has enough free space to accommodate a larger Hibernation file.

- To display the amount of RAM in the system:
 - Press **Fn+esc**.
 - **In Windows XP**, select Start > Control Panel > Performance and Maintenance > System > General tab.
 - **In Windows 2000**, select Start > Settings > Control Panel > System > General tab.
- To display the amount of free space on your hard drive, double-click the My Computer icon on the desktop, then select your hard drive. Information about the space on the drive is displayed in a status bar at the bottom of the window.
- To display the amount of space required by the Hibernation file:
 - **In Windows XP**, select Start > Control Panel > Performance and Maintenance > Power Options icon > Hibernate tab.
 - **In Windows 2000**, select Start > Settings > Control Panel > HP Power > Hibernation tab.

The free space on your hard drive and the size of the Hibernation file should match or exceed the amount of memory in your system.

Specifications

The information in this chapter might be helpful if you plan to use or transport the notebook internationally or in extreme environments.



Use only compatible AC adapters and battery packs with the notebook. For additional information, visit the HP Web site at <http://www.hp.com> or use the *Worldwide Telephone Numbers* booklet included with your notebook to contact an HP Customer Care Center.

Operating Environment

Factor	Metric	U.S.
Temperature		
Operating (not writing optical)	0°C to 35°C	32°F to 95°F
Operating (writing optical)	5°C to 35°C	41°F to 95°F
Nonoperating	-20°C to 60°C	-4°F to 140°F
Relative humidity (noncondensing)		
Operating	10% to 90%	10% to 90%
Nonoperating	5% to 95%	5% to 95%
Maximum altitude (unpressurized)		
Operating	-15 m to 3,048 m	-50 ft to 10,000 ft
Nonoperating	-15 m to 12,190 m	-50 ft to 40,000 ft

Rated Input Power

Input Power	Rating
Operating voltage	100 to 120/220 to 240 V ac RMS
Operating current	1.6/0.8 A RMS
Operating frequency range	50 to 60 Hz AC
When powered by a DC source	18.5V MAX

 This product is designed for IT power systems in Norway with phase-to-phase voltage not exceeding 240 Vrms.

Modem Specifications

This notebook has been tested and found to comply with the limits for a Class B digital device. For additional governmental agency information, refer to the *Regulatory and Safety Notices* guide on the *Documentation Library* CD.

Factor	Specification
Temperature	
Operating	0°C to 75°C (32°F to 167°F)
Storage	-40°C to 75°C (-40°F to 167°F)
Relative humidity (noncondensing)	
Operating	10% to 90%
Nonoperating	5% to 95% @ 39°C (5% to 95% @ 102°F)
Interfaces	Communications connector Standard RJ-11 connector
Power Requirements	+3.3 volts $\pm 5\%$, +5 volts $\pm 5\%$

Index

A

- AC adapter, disconnecting 3-1
- AC power connector 1-7
- adapter, modem 6-4
- Aircraft Power Adapter (optional)
3-12, 3-18
- airport security devices 4-1
- analog vs. digital line 6-1
- antennae 1-6
- applications key 1-3
- audio devices, connecting external
5-2
- audio line-out jack 1-4, 5-2
- Automobile Power
Adapter/Charger (optional)
3-12, 3-17

B

- battery bay, primary 1-9
- battery charge information
displays
 - hotkey 2-5
 - in Windows 3-14
 - increasing accuracy 3-13
 - interpreting 3-14
 - on battery pack 3-15
- battery connector, travel 1-8
- battery light 1-10, 3-12, 3-16

- battery pack
 - calibrating 3-18
 - charging 3-11, 3-19
 - conserving power 3-22
 - discharging 3-11, 3-20
 - disposal and recycling 3-25
 - low-battery condition 3-16
 - monitoring charge of 3-13
 - recharging 3-21
 - storing 3-1, 3-24
 - type 3-2
 - See also* battery power
- battery pack, primary
 - inserting 3-3
 - removing 3-5
- battery pack, travel
 - attaching 3-8
 - detaching 3-11
 - inserting 3-6
 - removing battery pack 3-7
- battery power
 - conserving 3-22
 - running notebook on 3-1, 3-2
 - See also* battery pack
- battery power gauge 1-9
- battery Quick Check 3-15
- battery release latch 1-9

- Bluetooth 2–9, 6–9
- Bluetooth label, location 1–11
- bottom components 1–8
- buttons
 - mute 2–9, 5–1
 - PC Card eject 1–4, 8–3
 - pointing stick 1–1, 2–1
 - power 1–2
 - Presentation Mode 2–9
 - Quick Launch 1–2, 2–9
 - Quick Lock 2–9
 - TouchPad 1–1, 2–2
 - volume control 5–1
 - Wireless On/Off 2–9

C

- cable slot, security 1–5
- cable, modem 6–1, 6–3
- cables
 - modem 6–1
- calibration, battery pack 3–18
- caps lock light 1–10
- charge sequence 3–11
- compartments
 - memory expansion 1–9
 - Mini PCI (Peripheral Component Interconnect) 1–9
 - primary memory 1–3
- Computer Setup
 - enabling USB legacy support 7–3
 - navigating 2–12
 - navigating in 7–3
- connecting external devices 7–1

- connectors

- AC power 1–7
- docking 1–8
- drive 4–1
- external monitor 1–7
- External MultiBay 1–7
- travel battery 1–8, 3–8
- USB 1–7

- country-specific modem cable adapter 6–4

- critical low-battery condition 3–17

D

- device drivers 7–1, 8–1
- digital vs. analog line 6–1
- discharge sequence 3–11
- display
 - switching image to or from 2–5, 7–2
- display release latch 1–3, 1–6
- docking connector 1–8
- drive media affected by airport security 4–1
- drives
 - affected by airport security 4–1
 - caring for 4–1
 - connectors 4–1
 - shipping 4–1

E

- electrostatic discharge (ESD) 4–1
- environmental specifications 9–1
- ESD (electrostatic discharge) 4–1
- exhaust vent 1–5
- external devices (optional) 7–1
- external monitor connector 1–7

External MultiBay (optional) 7–4
External MultiBay connector 1–7

F

Fn key 1–3
front components 1–6
function keys 1–3

H

hard drive
 caring for 4–1
 inserting 4–5
 removing 4–3
 replacing 4–3
 retaining screw 4–3, 4–6
hard drive activity light 1–10, 4–2
hard drive bay 1–5

Hibernation

 and low-battery conditions
 3–17
 disabling 3–20
 enabling 3–17, 3–22
 exiting 1–2
 file space requirements for
 8–14
 initiating for battery removal
 3–5
 initiating to conserve power
 3–23

hotkeys

 quick reference to commands
 2–5
 using with external keyboard
 2–8

hub, USB 7–3

humidity specifications 9–1

I

infrared

 linking to a device 6–7
 transmissions 6–8
 using Standby with 6–8

infrared port 1–4, 6–7

intake vent 1–9

J

jacks

 audio line-out 1–4, 5–2
 microphone input 1–4, 5–2
 RJ-11 1–7, 6–1
 RJ-45 1–7
 S-Video-out 5–3

K

keyboard, USB 7–2

keypads

 using embedded 2–10
 using external 2–11

keys

 applications 1–3
 Fn 1–3
 function 1–3
 Windows logo 1–3

L

labels 1–11

LAN, wireless 6–9

latches

 battery release 1–9
 display release 1–6

left-side components 1–4

lights

- battery 1–10, 3–12
- caps lock 1–10
- hard drive activity 1–10, 4–2
- num lock 1–10
- power/Standby 1–10
- scroll lock 1–10
- wireless on/off 1–10

low-battery conditions, identifying 3–16

M

magnetic fields, protecting drives from 4–1

maximum altitude 9–1

memory

- adding memory expansion board 8–6
- expansion compartment 8–6
- primary slot 1–3, 8–6
- upgrading primary board 8–10

memory expansion compartment 1–9

microphone input jack 1–4, 5–2

microphone, internal 1–6, 5–2

Mini PCI (Peripheral Component Interconnect), compartment 1–9

Modem and Networking guide 6–3, 6–4

modem approval label, location 1–11

modem cable 6–1, 6–3

Modem Command Guidelines (Advanced Users Only) 6–3

modem country-specific adapter 6–4

modem jack 1–7

monitor connector, external (optional) 7–1

mute button 5–1

N

network cable 6–6

network jack 1–7

noise suppression circuitry 6–2, 6–5

NTSC color television format 5–5

num lock light 1–10

num lock mode, enabling and disabling 2–12

O

operating current 9–2

operating environment specifications 9–1

operating frequency range 9–2

operating voltage 9–2

overhead projector (optional) connecting 7–1

switching display to or from 2–5, 7–2

overhead projector (optional), external monitor connector 1–7

P

PAL, PAL-M television formats 5–5

PC Card

inserting 8–2

stopping 8–3

zoomed video 8–1

PC Card eject button 1–4

PC Card slot 1–4

- peripherals, connecting and
 - disconnecting 7-1
- pointing stick
 - buttons 1-1, 2-2
 - location 1-1, 2-1
- pointing stick cap, changing 2-2
- Port Replicator (optional)
 - charging a battery pack with 3-12
 - docking connector 1-8
 - using the travel battery with 3-12
- power
 - rated input 9-2
 - switching between AC and battery 3-1
 - See also* battery power
- power button 1-2
- power connector 1-7
- Power Meter (Windows) 3-14
- power/Standby light 1-10
- powered USB 1-7
- powered USB hubs 7-3
- preferences
 - external keypad 2-12
 - pointing device 2-4
 - power 3-16, 3-23
 - security 2-9
- Presentation Mode button 2-9
- primary battery pack 3-3
- Product Key, location 1-11
- product number, location 1-11
- projector (optional), connecting 7-1
- protecting the notebook from damage 4-1

Q

- Quick Check, battery 3-15
- Quick Launch buttons 1-2, 2-9
- QuickLock button 2-9

R

- RAM (random access memory)
 - See* memory
- rated input power 9-2
- rear components 1-7
- release latches
 - battery 1-9
 - display 1-6
- right-side components 1-5
- RJ-11 jack 1-7
- RJ-45 jack 1-7

S

- scroll lock light 1-10
- SD (Secure Digital) Card
 - inserting 8-4
 - removing 8-5
- SD (Secure Digital) Card slot 1-4
- security cable slot 1-5
- serial number, location 1-11
- shortcut keys
 - quick reference 2-5
 - using on external keyboard 2-8
- slots
 - memory 1-3, 8-7, 8-12
 - PC Card 1-4, 8-2
 - SD Card 1-4, 8-4
 - security cable 1-5
- speaker, internal
 - audio line-out jack 1-4
 - identifying 1-4, 5-2

speakers, external (optional)

audio line-out jack 5-2

connecting 5-2

Standby

and low-battery conditions

3-17

exiting 1-2

initiating to conserve power

3-23

initiating with hotkey 2-5

using with infrared 6-8

Standby light 1-10

S-Video, connecting cable 5-4

S-Video-out jack 1-7, 5-4

switching display and image 2-5,
7-2

system information 2-5

T

telephone (RJ-11) jack, location

1-7

television (optional)

changing color mode 5-5

connecting audio 5-4

connecting video 5-4

S-Video-out jack 1-7, 5-4

switching image to or from 2-5

temperature, storage for battery

packs 3-24

top components 1-2

TouchPad

location 1-1, 2-2

using 2-3

TouchPad buttons 1-1, 2-2

travel battery pack

attaching 3-8

charge sequence 3-11

detaching 3-11

inserting into caddy 3-6

removing from caddy 3-7

travel battery pack connector 1-8,
3-8

travel battery pack locking switch
3-10

traveling with the notebook

Aircraft Power Adapter

(optional) 3-12, 3-18

Automobile Power

Adapter/Charger (optional)

3-12, 3-17

battery pack temperature

considerations 3-24

protecting drives 4-1

protecting hardware connectors
8-2, 8-4

U

USB

legacy support 7-3

with power connector 1-7

USB connectors 1-7

USB devices 7-3

USB hubs 7-3

V

VCR (optional)

connecting audio 5-4

connecting video 1-7, 5-3

switching image to or from 2-5,
7-2

vents

exhaust 1–5

intake 1–9

video devices (optional)

S-Video-out jack 1–7, 5–4

switching image to or from 2–5,
7–2

volume controls 5–1

W

Windows applications key 1–3

Windows logo key 1–3

wireless LAN, using 6–9

Wireless On/Off button 1–2, 2–9

wireless on/off light 1–10

WLAN label, location 1–11