

Thank you for purchasing this Factory Service Manual CD/DVD from [servicemanuals4u.com](http://servicemanuals4u.com).

Please check out our eBay auctions for more great deals on Factory Service Manuals:

[servicemanuals4u](http://servicemanuals4u.com)

Dell™ Inspiron™ 600m

# Owner's Manual



# Notes, Notices, and Cautions



**NOTE:** A NOTE indicates important information that helps you make better use of your computer.



**NOTICE:** A NOTICE indicates either potential damage to hardware or loss of data and tells you how to avoid the problem.



**CAUTION:** A CAUTION indicates a potential for property damage, personal injury, or death.

## Abbreviations and Acronyms

For a complete list of abbreviations and acronyms, see the *Tell Me How* help file. To access the help file, see page 98.

---

**Information in this document is subject to change without notice.**

**© 2002–2003 Dell Computer Corporation. All rights reserved.**

Reproduction in any manner whatsoever without the written permission of Dell Computer Corporation is strictly forbidden.

Trademarks used in this text: *Dell*, the *DELL* logo, *Inspiron*, *Dell TravelLite*, *Dell TrueMobile*, *Dell Precision*, *Dimension*, *OptiPlex*, *DellNet*, and *Latitude* are trademarks of Dell Computer Corporation; *Intel*, *Pentium*, and *Celeron* are registered trademarks of Intel Corporation; *Microsoft* and *Windows* are registered trademarks of Microsoft Corporation; *Bluetooth* is a trademark owned by Bluetooth SIG, Inc., and is used by Dell Computer Corporation under license; *EMC* is a registered trademark of the EMC Corporation.

Other trademarks and trade names may be used in this document to refer to either the entities claiming the marks and names or their products. Dell Computer Corporation disclaims any proprietary interest in trademarks and trade names other than its own.

**Model PP05L**

**July 2003**

**P/N 4N142**

**Rev. A01**

# Contents

<b>CAUTION: Safety Instructions</b> . . . . .	<b>11</b>
General . . . . .	11
Power . . . . .	12
Battery . . . . .	13
Air Travel . . . . .	14
EMC Instructions . . . . .	14
California Residents . . . . .	14
<b>When Using Your Computer</b> . . . . .	<b>15</b>
Ergonomic Computing Habits . . . . .	16
When Working Inside Your Computer . . . . .	16
Protecting Against Electrostatic Discharge . . . . .	17
Battery Disposal . . . . .	17

## 1 A Tour of Your Computer

<b>Front View</b> . . . . .	<b>20</b>
<b>Left Side View</b> . . . . .	<b>23</b>
<b>Right Side View</b> . . . . .	<b>25</b>
<b>Back View</b> . . . . .	<b>26</b>
<b>Bottom View</b> . . . . .	<b>30</b>

## 2 Setting Up Your Computer

<b>Connecting to the Internet</b> . . . . .	<b>34</b>
Setting Up Your Internet Connection . . . . .	34

<b>Modem and Internet Connection Problems</b> . . . . .	<b>35</b>
<b>E-Mail Problems</b> . . . . .	<b>36</b>
<b>Transferring Information to a New Computer</b> . . . . .	<b>37</b>
<b>Setting Up a Printer</b> . . . . .	<b>38</b>
Printer Cable . . . . .	39
Connecting a Parallel Printer . . . . .	39
Connecting a USB Printer . . . . .	40
<b>Printer Problems</b> . . . . .	<b>40</b>
<b>Setting Up the Docking Device to Connect to a Network</b> . . . . .	<b>41</b>
<b>Power Protection Devices</b> . . . . .	<b>41</b>
Surge Protectors . . . . .	42
Line Conditioners . . . . .	42
Uninterruptible Power Supplies . . . . .	42
<b>Turning Off Your Computer</b> . . . . .	<b>43</b>

### 3 Using Batteries and Module Bay Devices

<b>Using a Battery</b> . . . . .	<b>46</b>
Battery Performance . . . . .	46
Checking the Battery Charge . . . . .	47
Charging the Battery . . . . .	49
Removing a Battery . . . . .	49
Installing a Battery . . . . .	50
Removing and Installing a Reserve Battery . . . . .	51
Storing a Battery . . . . .	52
<b>Power Problems</b> . . . . .	<b>52</b>
<b>About the Module Bay</b> . . . . .	<b>53</b>
Checking the Charge on the Second Battery . . . . .	54
<b>Removing and Installing Devices While the Computer Is Turned Off</b> <b>54</b>	

If the Device Screw Is Not Installed . . . . .	55
If the Device Screw Is Installed . . . . .	56
<b>Removing and Installing Devices While the Computer Is Running</b>	<b>58</b>
If the Device Screw Is Not Installed . . . . .	58
If the Device Screw Is Installed . . . . .	60

## 4 Using the Keyboard and Touch Pad

<b>Numeric Keypad</b> . . . . .	<b>64</b>
<b>Keyboard Shortcuts</b> . . . . .	<b>65</b>
System Functions . . . . .	65
Battery . . . . .	65
CD or DVD Tray . . . . .	65
Display Functions . . . . .	65
Radios (Including Wireless Networking and Bluetooth™) . . . . .	65
Power Management . . . . .	66
Speaker Functions . . . . .	66
Microsoft® Windows® Logo Key Functions . . . . .	66
<b>Customizing the Touch Pad</b> . . . . .	<b>68</b>
<b>Touch Pad or Mouse Problems</b> . . . . .	<b>68</b>
<b>External Keyboard Problems</b> . . . . .	<b>68</b>
<b>Unexpected Characters</b> . . . . .	<b>69</b>

## 5 Using CDs, DVDs, and Other Multimedia

<b>Using CDs and DVDs</b> . . . . .	<b>72</b>
<b>CD and DVD Problems</b> . . . . .	<b>72</b>
If you cannot play a CD or DVD . . . . .	72
If you cannot eject the CD, CD-RW, or DVD drive tray . . . . .	72
If you hear an unfamiliar scraping or grinding sound . . . . .	73
If the CD-RW drive stops writing . . . . .	73

<b>Sound and Speaker Problems</b> . . . . .	<b>73</b>
If you have a problem with integrated speakers . . . . .	73
If you have a problem with external speakers . . . . .	73
<b>Copying CDs</b> . . . . .	<b>74</b>
Using Easy CD Creator Basic . . . . .	75
Using Blank CD-R Discs or Blank CD-RW Discs . . . . .	75
Helpful Tips . . . . .	75
How to Copy a CD . . . . .	76
<b>Connecting a Television to the Computer</b> . . . . .	<b>77</b>
S-Video Connection . . . . .	78
Composite Video Connection . . . . .	80
Enabling the Display Settings for a Television . . . . .	82

## 6 Setting Up a Home and Office Network

<b>Connecting to a Network Adapter</b> . . . . .	<b>84</b>
<b>Network Setup Wizard</b> . . . . .	<b>84</b>
<b>Network Problems</b> . . . . .	<b>85</b>
<b>Connecting to Wireless Local Area Networks</b> . . . . .	<b>86</b>
Determining your Network Type . . . . .	86
Connecting to a Network in Windows XP . . . . .	87
Finalizing your Network Connection (Security Settings) . . . . .	90

## 7 Solving Problems

<b>Finding Solutions</b> . . . . .	<b>96</b>
<b>Accessing Help</b> . . . . .	<b>98</b>
<b>Error Messages</b> . . . . .	<b>98</b>
<b>Video and Display Problems</b> . . . . .	<b>99</b>
If the display is blank . . . . .	99

If the display is difficult to read . . . . .	100
If only part of the display is readable . . . . .	101
<b>Scanner Problems . . . . .</b>	<b>101</b>
<b>Drive Problems . . . . .</b>	<b>102</b>
If you cannot save a file to a floppy drive . . . . .	102
If you have problems with a hard drive . . . . .	103
<b>PC Card Problems . . . . .</b>	<b>103</b>
<b>General Program Problems . . . . .</b>	<b>104</b>
A program crashes . . . . .	104
A program stops responding . . . . .	104
Error messages appear . . . . .	104
<b>If Your Computer Gets Wet . . . . .</b>	<b>105</b>
<b>If You Drop or Damage Your Computer . . . . .</b>	<b>106</b>
<b>Resolving Other Technical Problems . . . . .</b>	<b>106</b>
<b>Drivers . . . . .</b>	<b>107</b>
What Is a Driver? . . . . .	107
Identifying Drivers . . . . .	107
Reinstalling Drivers and Utilities . . . . .	108
Manually Reinstalling Drivers for Windows XP . . . . .	109
<b>Using System Restore . . . . .</b>	<b>110</b>
Creating a Restore Point . . . . .	110
Restoring the Computer to an Earlier Operating State . . . . .	110
Undoing the Last System Restore . . . . .	111
<b>Resolving Software and Hardware Incompatibilities . . . . .</b>	<b>112</b>
<b>Reinstalling Microsoft® Windows® XP . . . . .</b>	<b>113</b>
Before You Reinstall . . . . .	113
Reinstalling Windows XP . . . . .	113
Reinstalling Drivers and Software . . . . .	115

## 8 Adding and Replacing Parts

<b>Adding Memory</b> . . . . .	<b>118</b>
<b>Adding a Mini PCI Card</b> . . . . .	<b>120</b>
<b>Replacing the Hard Drive</b> . . . . .	<b>123</b>

## 9 Appendix

<b>Specifications</b> . . . . .	<b>128</b>
<b>Standard Settings</b> . . . . .	<b>135</b>
Viewing the System Setup Screens . . . . .	135
System Setup Screens . . . . .	135
Commonly Used Options . . . . .	136
<b>Dell Technical Support Policy (U.S. Only)</b> . . . . .	<b>138</b>
Definition of "Dell-Installed" Software and Peripherals . . . . .	139
Definition of "Third-Party" Software and Peripherals . . . . .	139
<b>Contacting Dell</b> . . . . .	<b>139</b>
<b>Regulatory Notices</b> . . . . .	<b>157</b>
NOM Information (Mexico Only) . . . . .	158
<b>Limited Warranties and Return Policy</b> . . . . .	<b>159</b>
Limited Warranty for Dell-Branded Hardware Products (U.S. Only) . . . . .	159
"Total Satisfaction" Return Policy (U.S. Only) . . . . .	163
Limited Warranty Terms for Dell-Branded Hardware Products (Canada Only) . . . . .	163
"Total Satisfaction" Return Policy (Canada Only) . . . . .	167
Dell Software and Peripherals (Canada Only) . . . . .	167
1-Year End-User Manufacturer Guarantee (Latin America and the Caribbean Only) . . . . .	168
Intel® Warranty Statement for Pentium® and Celeron® Processors Only (U.S. and Canada Only) . . . . .	170

Index . . . . . 173



## **CAUTION: Safety Instructions**

Use the following safety guidelines to help ensure your own personal safety and to help protect your computer and working environment from potential damage.

### **General**

- Do not attempt to service the computer yourself unless you are a trained service technician. Always follow installation instructions closely.
- If you use an extension power cable with your AC adapter, ensure that the total ampere rating of the products plugged in to the extension power cable does not exceed the ampere rating of the extension cable.
- Do not push objects into air vents or openings of your computer. Doing so can cause fire or electric shock by shorting out interior components.
- Do not store your computer in a low-airflow environment, such as a carrying case or a closed briefcase, while the computer is turned on. Restricting airflow can damage the computer or cause a fire.
- Keep your computer away from radiators and heat sources. Also, do not block cooling vents. Avoid placing loose papers underneath your computer; do not place your computer in a closed-in wall unit or on a bed, sofa, or rug.
- Place the AC adapter in a ventilated area, such as a desk top or on the floor, when you use it to run the computer or to charge the battery. Do not cover the AC adapter with papers or other items that will reduce cooling; also, do not use the AC adapter inside a carrying case.
- The AC adapter may become hot during normal operation of your computer. Use care when handling the adapter during or immediately after operation.
- Do not allow your portable computer to operate with the base resting directly on exposed skin for extended periods of time. The surface temperature of the base will rise during normal operation (particularly when AC power is present). Allowing sustained contact with exposed skin can cause discomfort or, eventually, a burn.
- Do not use your computer in a wet environment, for example, near a bath tub, sink, or swimming pool or in a wet basement
- If your computer includes an integrated or optional (PC Card) modem, disconnect the modem cable if an electrical storm is approaching to avoid the remote risk of electric shock from lightning via the telephone line.

## **CAUTION: Safety Instructions** *(continued)*

- To help avoid the potential hazard of electric shock, do not connect or disconnect any cables or perform maintenance or reconfiguration of this product during an electrical storm. Do not use your computer during an electrical storm unless all cables have been disconnected and the computer is operating on battery power.
- If your computer includes a modem, the cable used with the modem should be manufactured with a minimum wire size of 26 American wire gauge (AWG) and an FCC-compliant RJ-11 modular plug.
- Before you open the memory module/Mini PCI card/modem cover on the bottom of your computer, disconnect all cables from their electrical outlets and disconnect the telephone cable.
- If your computer has a modem RJ-11 connector and a network RJ-45 connector, insert the telephone cable into the RJ-11 connector, not the RJ-45 connector.
- PC Cards may become very warm during normal operation. Use care when removing PC Cards after their continuous operation.
- Before you clean your computer, disconnect the computer from the electrical outlet. Clean your computer with a soft cloth dampened with water. Do not use liquid or aerosol cleaners, which may contain flammable substances.

### **Power**

- Use only the Dell-provided AC adapter approved for use with this computer. Use of another AC adapter may cause a fire or explosion.
- Before you connect the computer to an electrical outlet, check the AC adapter voltage rating to ensure that the required voltage and frequency match the available power source.
- To remove the computer from all power sources, turn the computer off, remove the battery pack, and disconnect the AC adapter from the electrical outlet.
- To help prevent electric shock, plug the AC adapter and device power cables into properly grounded power sources. These power cables may be equipped with 3-prong plugs to provide an earth grounding connection. Do not use adapter plugs or remove the grounding prong from the power cable plug. If you use a power extension cable, use the appropriate type, 2-prong or 3-prong, to mate with the AC adapter power cable.
- Be sure that nothing rests on your AC adapter's power cable and that the cable is not located where it can be tripped over or stepped on.

## **CAUTION: Safety Instructions (*continued*)**

- If you are using a multiple-outlet power strip, use caution when plugging the AC adapter's power cable into the power strip. Some power strips may allow you to insert the plug incorrectly. Incorrect insertion of the power plug could result in permanent damage to your computer, as well as risk of electric shock and/or fire. Ensure that the ground prong of the power plug is inserted into the mating ground contact of the power strip.

### **Battery**

- Use only Dell™ battery modules that are approved for use with this computer. Use of other types may increase the risk of fire or explosion.
- Do not carry a battery pack in your pocket, purse, or other container where metal objects (such as car keys or paper clips) could short-circuit the battery terminals. The resulting excessive current flow can cause extremely high temperatures and may result in damage to the battery pack or cause fire or burns.
- The battery poses a burn hazard if you handle it improperly. Do not disassemble it. Handle a damaged or leaking battery pack with extreme care. If the battery is damaged, electrolyte may leak from the cells and may cause personal injury.
- Keep the battery away from children.
- Do not store or leave your computer or battery pack near a heat source such as a radiator, fireplace, stove, electric heater, or other heat-generating appliance or otherwise expose it to temperatures in excess of 60°C (140°F). When heated to excessive temperatures, battery cells could explode or vent, posing a risk of fire.
- Do not dispose of your computer's battery in a fire or with normal household waste. Battery cells may explode. Discard a used battery according to the manufacturer's instructions or contact your local waste disposal agency for disposal instructions. Dispose of a spent or damaged battery promptly.

# **CAUTION: Safety Instructions (*continued*)**

## **Air Travel**

- Certain Federal Aviation Administration regulations and/or airline-specific restrictions may apply to the operation of your Dell computer while you are on board an aircraft. For example, such regulations/restrictions may prohibit the use of any personal electronic device (PED) that has the capacity for intentional transmission of radio frequency or other electromagnetic signals while on an aircraft.
  - In order to best comply with all such restrictions, if your Dell portable computer is equipped with Dell TrueMobile™ or some other wireless communication device, please disable this device before you board the aircraft and follow all instructions provided by airline personnel with regard to such device.
  - Additionally, the use of any PED, such as a portable computer, may be prohibited in aircraft during certain critical phases of flight, for example, takeoff and landing. Some airlines may further define the critical flight phase as any time the aircraft is below 3050 m (10,000 ft). Please follow the airline's specific instructions as to when the use of a PED is allowed.

## **EMC Instructions**

Use shielded signal cables to ensure that you maintain the appropriate EMC classification for the intended environment. For parallel printers, a cable is available from Dell. If you prefer, you can order a cable from Dell at its worldwide website at [www.dell.com](http://www.dell.com).

Static electricity can harm electronic components inside your computer. To prevent static damage, discharge static electricity from your body before you touch any of your computer's electronic components, such as a memory module. You can do so by touching an unpainted metal surface on the computer's input/output panel.

## **California Residents**

**WARNING:** Handling the cord on this product, or cords associated with accessories sold with this product, will expose you to lead, a chemical known to the State of California to cause birth defects or other reproductive harm. ***Wash your hands after handling the cord.***

# When Using Your Computer

Observe the following safe-handling guidelines to prevent damage to your computer:

- When setting up the computer for work, place it on a level surface.
- When traveling, do not check the computer as baggage. You can put your computer through an X-ray security machine, but never put your computer through a metal detector. If you have the computer checked by hand, be sure to have a charged battery available in case you are asked to turn on the computer.
- When traveling with the hard drive removed from the computer, wrap the drive in a nonconducting material, such as cloth or paper. If you have the drive checked by hand, be ready to install the drive in the computer. You can put the hard drive through an X-ray security machine, but never put the drive through a metal detector.
- When traveling, do not place the computer in overhead storage compartments where it could slide around. Do not drop your computer or subject it to other mechanical shocks.
- Protect your computer, battery, and hard drive from environmental hazards such as dirt, dust, food, liquids, temperature extremes, and overexposure to sunlight.
- When you move your computer between environments with very different temperature and/or humidity ranges, condensation may form on or within the computer. To avoid damaging the computer, allow sufficient time for the moisture to evaporate before using the computer.



**NOTICE:** When taking the computer from low-temperature conditions into a warmer environment or from high-temperature conditions into a cooler environment, allow the computer to acclimate to room temperature before turning on power.

- When you disconnect a cable, pull on its connector or on its strain-relief loop, not on the cable itself. As you pull out the connector, keep it evenly aligned to avoid bending any connector pins. Also, before you connect a cable make sure both connectors are correctly oriented and aligned.
- Handle components with care. Hold a component such as a memory module by its edges, not its pins.
- When preparing to remove a memory module from the system board or disconnect a device from the computer, turn off the computer, disconnect the AC adapter cable, and then wait 5 seconds before proceeding to help avoid possible damage to the system board.

## When Using Your Computer *(continued)*

- Clean the display with a soft, clean cloth and water. Apply the water to the cloth; then stroke the cloth across the display in one direction, moving from the top of the display to the bottom. Remove moisture from the display quickly and keep the display dry. Long-term exposure to moisture can damage the display. *Do not* use a commercial window cleaner to clean your display.
- If your computer gets wet or is damaged, follow the procedures described in "If Your Computer Gets Wet" on page 105 or "If You Drop or Damage Your Computer" on page 106. If, after following these procedures, you confirm that your computer is not operating properly, contact Dell (see "Contacting Dell" on page 139 for the appropriate contact information).

### Ergonomic Computing Habits

 **CAUTION:** Improper or prolonged keyboard use may result in injury.



 **CAUTION:** Viewing the display or external monitor screen for extended periods of time may result in eye strain.

For comfort and efficiency, observe the ergonomic guidelines in the *Tell Me How* help file when setting up and using your computer. To access the help file, see "Accessing Help" on page 98.

This portable computer is not designed for continuous operation as office equipment. For extended use in an office, it is recommended that you connect an external keyboard.

### When Working Inside Your Computer

Before removing or installing memory modules, Mini PCI cards, or modems, perform the following steps in the sequence indicated.

-  **NOTICE:** The only time you should ever access the inside of your computer is when you are installing memory modules, a Mini PCI card, or a modem.
  -  **NOTICE:** Wait 5 seconds after turning off the computer before disconnecting a device or removing a memory module, Mini PCI card, or modem to help prevent possible damage to the system board.
- 1 Shut down your computer and turn off any attached devices.
  - 2 Disconnect your computer and devices from electrical outlets to reduce the potential for personal injury or shock. Also, disconnect any telephone or telecommunication lines from the computer.
  - 3 Remove the main battery from the battery bay and, if necessary, the secondary battery from the module bay.

## When Using Your Computer (*continued*)

- 4 Ground yourself by touching the unpainted metal surface of the I/O panel on the back of the computer.

While you work, periodically touch the I/O panel to dissipate any static electricity that might harm internal components.

### Protecting Against Electrostatic Discharge

Static electricity can harm electronic components inside your computer. To prevent static damage, discharge static electricity from your body before you touch any of your computer's electronic components, such as a memory module. You can do so by touching an unpainted metal surface on the computer's I/O panel.

As you continue to work inside the computer, periodically touch an I/O connector to remove any static charge your body may have accumulated.

You can also take the following steps to prevent damage from electrostatic discharge (ESD):

- When unpacking a static-sensitive component from its shipping carton, do not remove the component from the antistatic packing material until you are ready to install the component. Just before unwrapping the antistatic packaging, be sure to discharge static electricity from your body.
- When transporting a sensitive component, first place it in an antistatic container or packaging.
- Handle all sensitive components in a static-safe area. If possible, use antistatic floor pads and workbench pads.



### Battery Disposal

Your computer uses a lithium-ion battery and a reserve battery. For instructions about replacing the lithium-ion battery in your computer, see "Using a Battery" on page 46. The reserve battery is a long-life battery, and it is very possible that you will never need to replace it. However, should you need to replace it, see page 51 for instructions.

Do not dispose of the battery along with household waste. Contact your local waste disposal agency for the address of the nearest battery deposit site.



SECTION 1

# A Tour of Your Computer

---

Front View

Left Side View

Right Side View

Back View

Bottom View

## Front View

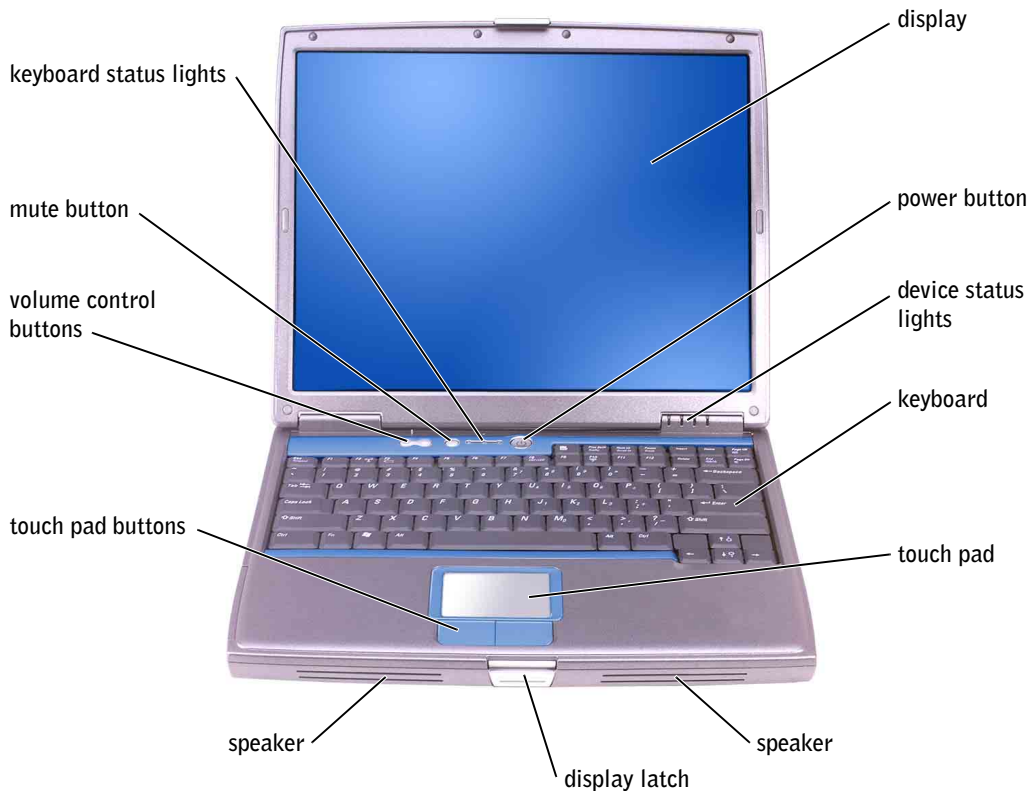

**DISPLAY** — For more information about your display, see the *Tell Me How* help file. To access the help file, see "Accessing Help" on page 98.







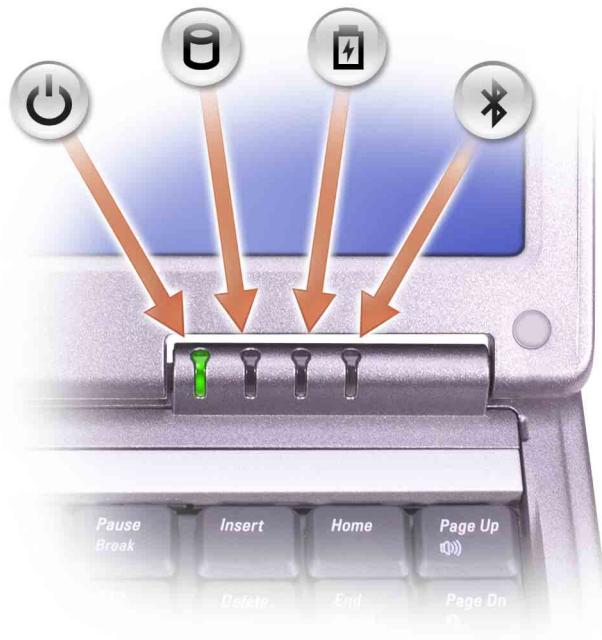

**POWER BUTTON** — Press the power button to turn on the computer or exit a power management mode. For more information about power management, see the *Tell Me How* help file. To access the help file, see "Accessing Help" on page 98.

**NOTICE:** To avoid losing data, turn off your computer by performing a Microsoft® Windows® operating system shutdown (see "Turning Off Your Computer" on page 43) rather than by pressing the power button.

If the computer stops responding, press and hold the power button until the computer turns off completely (which may take several seconds).

## DEVICE STATUS LIGHTS



- 
-  Turns on when you turn on the computer and blinks when the computer is in a power management mode.
- 
-  Turns on when the computer reads or writes data.
-  **NOTICE:** To avoid loss of data, never turn off the computer while the  light is flashing.
- 
-  Turns on steadily or blinks to indicate battery charge status.
- 
-  Turns on when Bluetooth™ is enabled. To enable or disable Bluetooth, press  
- 

If the computer is connected to an electrical outlet, the  light operates as follows:

- Solid green: The battery is charging.
- Flashing green: The battery is almost fully charged.

If the computer is running on a battery, the  light operates as follows:

- Off: The battery is adequately charged (or the computer is turned off).
- Flashing orange: The battery charge is low.
- Solid orange: The battery charge is critically low.

**KEYBOARD** — The keyboard includes a numeric keypad as well as the Windows logo key . For information on supported keyboard shortcuts, see "Using the Keyboard and Touch Pad" on page 63.

**TOUCH PAD** — Provides the functionality of a mouse. See "Using the Keyboard and Touch Pad" on page 63 for more information.

**SPEAKERS** — To adjust the volume of the integrated speakers, press the volume control buttons, mute button, or volume-control keyboard shortcuts. For more information, see "Using the Keyboard and Touch Pad" on page 63.

**DISPLAY LATCH** — Keeps the display closed.

**TOUCH PAD BUTTONS** — Provide the functionality of a mouse. See "Using the Keyboard and Touch Pad" on page 63 for more information.



**VOLUME CONTROL BUTTONS** — Press these buttons to adjust the volume.

**MUTE BUTTON** — Press this button to turn off the volume.

#### **KEYBOARD STATUS LIGHTS**



The green lights located above the keyboard indicate the following:

	Turns on when the numeric keypad is enabled.
	Turns on when the uppercase letter function is enabled.
	Turns on when the scroll lock function is enabled.

## Left Side View

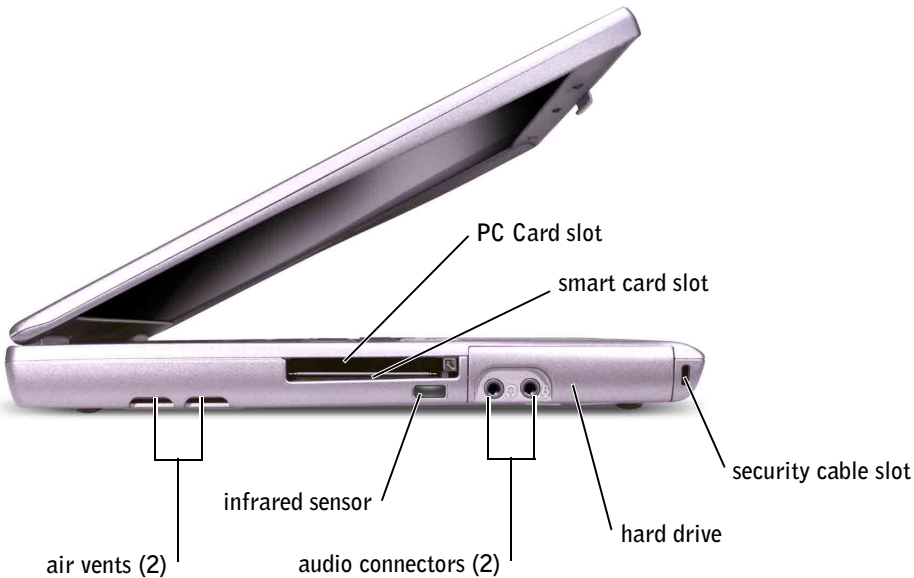

**AIR VENTS** — The computer uses an internal fan to create airflow through the vents, which prevents the computer from overheating.

**CAUTION:** Do not block, push objects into, or allow dust to accumulate in the air vents. Do not store your Dell™ computer in a low-airflow environment, such as a closed briefcase, while it is running. Restricting the airflow can damage the computer or cause a fire.

**PC CARD SLOT** — Supports one PC Card, such as a modem or network adapter. The computer ships with a plastic blank installed in the slot. For more information,

**NOTE:** The computer turns on the fan when the computer gets hot. Fan noise is normal and does not indicate a problem with the fan or the computer.

see the *Tell Me How* help file. To access the help file, see "Accessing Help" on page 98.

**SMART CARD SLOT** — Supports one smart card. For more information, see the *Tell Me How* help file. To access the help file, see "Accessing Help" on page 98.

**INFRARED SENSOR** — Lets you transfer files from your computer to another infrared-compatible device without using cable connections.

When you receive your computer, the sensor is disabled. You can use the system setup program to enable the sensor. For information on transferring data, see the Help and Support Center or the documentation that came with your infrared-compatible device.

#### **AUDIO CONNECTORS**

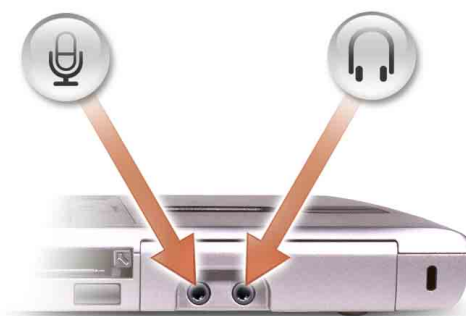

---

Attach a microphone to the  connector.

---

Attach headphones or speakers to the  connector.

---

**HARD DRIVE** — Stores software and data.

**SECURITY CABLE SLOT** — Lets you attach a commercially available antitheft device to the computer. For more information, see the instructions included with the device.

 **NOTICE:** Before you buy an antitheft device, ensure that it will work with the security cable slot.



## Right Side View



**SECURITY CABLE SLOT** — Lets you attach a commercially available antitheft device to the computer. For more information, see the instructions included with the device.

**NOTICE:** Before you buy an antitheft device, ensure that it will work with the security cable slot.



**MODULE BAY** — You can install devices such as an optical drive or a Dell TravelLite™ module in the module bay. For more information, see "About the Module Bay" on page 53.

**DEVICE LATCH RELEASE** — Releases the module bay device. See "About the Module Bay" on page 53 for instructions.

## Back View

 **NOTICE:** To avoid damaging the computer, wait 5 seconds after turning off the computer before you disconnect an external device.

 **CAUTION:** Do not block, push objects into, or allow dust to accumulate in the air vents. Do not store your computer in a low-airflow environment, such as a closed briefcase, while it is running. Restricting the airflow can damage the computer or cause a fire.

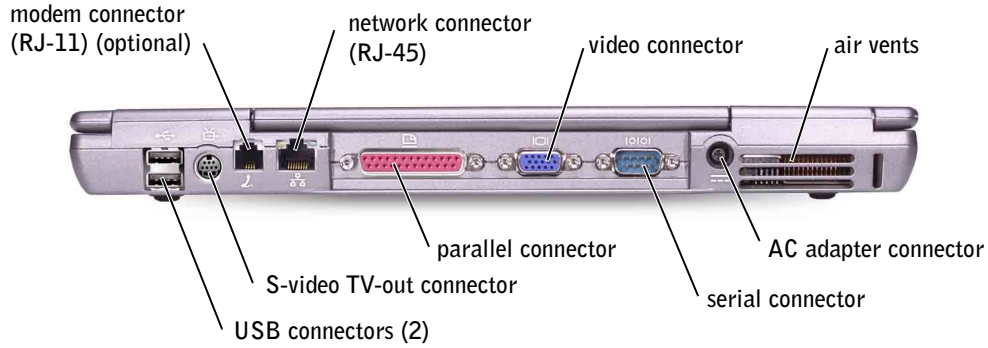

## USB CONNECTORS



Connect USB devices, such as a mouse, keyboard, or printer. You can also connect the optional floppy drive directly to a USB connector using the optional floppy drive cable.



---

**S-VIDEO TV-OUT CONNECTOR**

---



Connects your computer to a TV. For more information, see "Connecting a Television to the Computer" on page 77.

---

**MODEM CONNECTOR (RJ-11) (OPTIONAL)**

---



If you ordered the optional internal modem, connect the telephone line to the modem connector.

For information on using the modem, see the online modem documentation supplied with your computer. See "Accessing Help" on page 98.

---

**NETWORK CONNECTOR (RJ-45)**

**NOTICE:** The network connector is slightly larger than the modem connector. To avoid damaging the computer, do not plug a telephone line into the network connector.

---

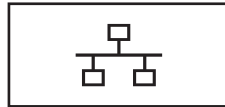

Connects the computer to a network. The green and yellow lights next to the connector indicate activity for both wired and wireless network communications.

For information on using the network adapter, see the device user's guide supplied with your computer. See "Accessing Help" on page 98.

---

**PARALLEL CONNECTOR**

---



Connects a parallel device, such as a printer.

---

**VIDEO CONNECTOR**

---



Connects an external monitor. For more information, see the *Tell Me How* help file. To access the help file, see "Accessing Help" on page 98.

---

## SERIAL CONNECTOR

---

Connects serial devices, such as a mouse or handheld device.



1 0 1 0 1

---

**AC ADAPTER CONNECTOR** — Attach an AC adapter to the computer.



The AC adapter converts AC power to the DC power required by the computer. You can connect the AC adapter with your computer turned either on or off.

**⚠ CAUTION:** The AC adapter works with electrical outlets worldwide. However, power connectors and power strips vary among countries. Using an incompatible cable or improperly connecting the cable to the power strip or electrical outlet may cause fire or equipment damage.

**➡ NOTICE:** When you disconnect the AC adapter cable from the computer, grasp the connector, not the cable itself, and pull firmly but gently to avoid damaging the cable.

**AIR VENTS** — The computer uses an internal fan to create airflow through the vents, which prevents the computer from overheating.

**NOTE:** The computer turns on the fan when the computer gets hot. Fan noise is normal and does not indicate a problem with the fan or the computer.

**CAUTION:** Do not block, push objects into, or allow dust to accumulate in the air vents. Do not store your computer in a low-airflow environment, such as a closed briefcase, while it is running. Restricting the airflow can damage the computer or cause a fire.

## Bottom View

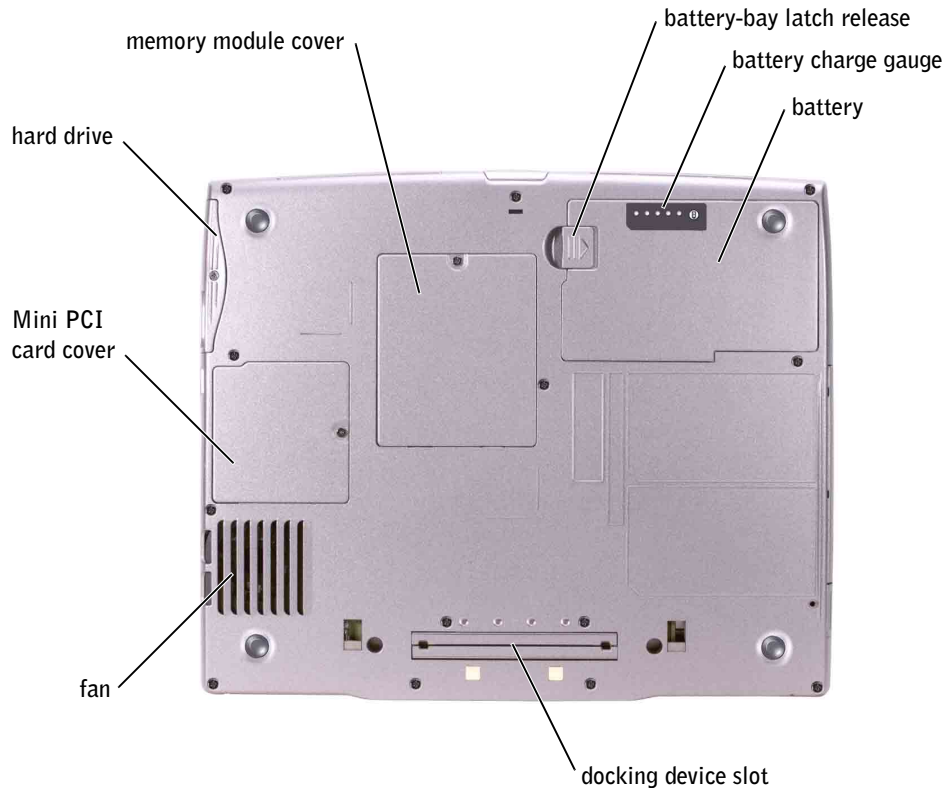

**MEMORY MODULE COVER** — Covers the compartment that contains the memory module(s). See "Adding Memory" on page 118.

**BATTERY-BAY LATCH RELEASE** — Releases the battery. See "Using a Battery" on page 46 for instructions.

**BATTERY CHARGE GAUGE** — Provides information on the battery charge. See "Using a Battery" on page 46.

**BATTERY** — When a battery is installed, you can use the computer without connecting the computer to an electrical outlet. See "Using a Battery" on page 46.

**DOCKING DEVICE SLOT** — Lets you attach your computer to a docking device. See the documentation that came with your docking device for additional information.

**FAN** — The computer uses an internal fan to create airflow through the vents, which prevents the computer from overheating.

 **CAUTION: Do not block, push objects into, or allow dust to accumulate in the air vents. Do not store your computer in a low-airflow environment, such as a closed briefcase, while it is running. Restricting the airflow can damage the computer or cause a fire.**

**MINI PCI CARD COVER** — Covers the compartment that contains the Mini PCI card. See "Adding a Mini PCI Card" on page 120.

**HARD DRIVE** — Stores software and data.

 **NOTE:** The computer turns on the fan when the computer gets hot. Fan noise is normal and does not indicate a problem with the fan or the computer.



SECTION 2

## Setting Up Your Computer

---

Connecting to the Internet

Modem and Internet Connection Problems

E-Mail Problems

Transferring Information to a New Computer

Setting Up a Printer

Printer Problems

Setting Up the Docking Device to Connect to a Network

Power Protection Devices

Turning Off Your Computer

 **NOTE:** ISPs and ISP offerings vary by country.

## Connecting to the Internet

To connect to the Internet, you need a modem or network connection and an Internet service provider (ISP), such as AOL or MSN. Your ISP will offer one or more of the following Internet connection options:

- Dial-up connections that provide Internet access through a phone line. Dial-up connections are considerably slower than DSL and cable modem connections.
- DSL connections that provide high-speed Internet access through your existing phone line. With a DSL connection, you can access the Internet and use your phone on the same line simultaneously.
- Cable modem connections that provide high-speed Internet access through your local cable TV line.

If you are using a dial-up connection, connect a telephone line to the modem connector on your computer and to the telephone wall jack before you set up your Internet connection. If you are using a DSL or cable modem connection, contact your ISP for setup instructions.

### Setting Up Your Internet Connection

To set up an AOL or MSN connection:

- 1 Save and close any open files, and exit any open programs.
- 2 Double-click the **MSN Explorer** or **AOL** icon on the Windows<sup>®</sup> desktop.
- 3 Follow the instructions on the screen to complete the setup.

If you do not have an **MSN Explorer** or **AOL** icon on your desktop or if you want to set up an Internet connection with a different ISP:

- 1 Save and close any open files, and exit any open programs.
- 2 Click the **Start** button and click **Internet Explorer**.  
The **New Connection Wizard** appears.
- 3 Click **Connect to the Internet**.
- 4 In the next window, click the appropriate option:
  - If you do not have an ISP and want to select one, click **Choose from a list of Internet service providers (ISPs)**.

- If you have already obtained setup information from your ISP but you did not receive a setup CD, click **Set up my connection manually**.
- If you have a CD, click **Use the CD I got from an ISP**.

## 5 Click Next.

If you selected **Set up my connection manually**, continue to step 6. Otherwise, follow the instructions on the screen to complete the setup.

- 6 Click the appropriate option under **How do you want to connect to the Internet?**, and then click **Next**.
- 7 Use the setup information provided by your ISP to complete the setup.

If you cannot connect to the Internet but have successfully connected in the past, the ISP might have a service outage. Contact your ISP to check the service status, or try connecting again later.



**NOTE:** If you do not know which type of connection to select, contact your ISP.

# Modem and Internet Connection Problems



**NOTICE:** Connect the modem to an analog telephone wall jack only. Connecting the modem to a digital telephone network damages the modem.



**NOTICE:** Modem and network connectors look similar. Do not plug a telephone line into the network connector.

**CHECK THE TELEPHONE WALL JACK** — Disconnect the telephone line from the modem and connect it to a telephone. Listen for a dial tone. Ensure that you have touchtone telephone service. Try connecting the modem to a different telephone wall jack.

Slow connection speeds can be caused by telephone noise as well as by telephone line or network conditions. Contact your telephone company or network administrator for more information.

**CONNECT THE MODEM DIRECTLY TO THE TELEPHONE WALL JACK** — If you have other telephone devices sharing the line, such as an answering machine, fax machine, surge protector, or line splitter, then bypass them and use the telephone line to connect the modem directly to the telephone wall jack.

**CHECK THE CONNECTION** — Verify that the telephone line is connected to the modem.

**CHECK THE TELEPHONE LINE** — Try using a different telephone line. If you are using a line that is 3 m (10 ft) or more in length, try a shorter one.



**NOTE:** If you can connect to your Internet service provider (ISP), your modem is functioning properly. If you are sure that your modem is working properly and you still experience problems, contact your ISP.

**IRREGULAR DIAL TONE** — If you have voice mail service, you might hear an irregular dial tone when you have messages. Contact your telephone company for instructions on restoring a dial tone.

**TURN OFF CALL WAITING (CATCH-PHONE)** — See your telephone directory for instructions on deactivating this feature. Then adjust the dial-up networking connection properties.

- 1 Click the **Start** button and click **Control Panel**.
- 2 Click **Printers and Other Hardware**, click **Phone and Modem Options**, click the **Dialing Rules** tab, and then click **Edit...**
- 3 In the **Edit Location** window, ensure that **To disable call waiting, dial:** is checked, and then select the proper code as listed in your telephone directory.
- 4 Click **Apply** and click **OK**.
- 5 Close the **Phone and Modems Options** window.
- 6 Close the **Control Panel** window.

**VERIFY THAT THE MODEM IS COMMUNICATING WITH WINDOWS** —

- 1 Click the **Start** button and click **Control Panel**.
- 2 Click **Printers and Other Hardware** and click **Phone and Modem Options**.
- 3 Click the **Modems** tab.
- 4 Click the COM port for your modem.
- 5 Click **Properties**, click the **Diagnostics** tab, and then click **Query Modem** to verify that the modem is communicating with Windows.

If all commands receive responses, the modem is operating properly.

## E-Mail Problems

**ENSURE THAT YOU ARE CONNECTED TO THE INTERNET** — With the Outlook Express e-mail program open, click **File**. If **Work Offline** has a check mark next to it, click the check mark to remove it and connect to the Internet.

# Transferring Information to a New Computer

The Microsoft® Windows® XP operating system provides a Files and Settings Transfer wizard to move data from the source computer to the new computer. You can move data such as:

- E-mails
- Toolbar settings
- Window sizes
- Internet bookmarks

You can transfer the data to the new computer over a network or serial connection, or you can store it on a removable medium, such as a writable CD or floppy disk.

To prepare the new computer for the file transfer:

- 1** Click the **Start** button, point to **All Programs**→**Accessories**→**System Tools**, and then click **Files and Settings Transfer Wizard**.
- 2** When the **Files and Settings Transfer Wizard** welcome screen appears, click **Next**.
- 3** On the **Which computer is this?** screen, click **New Computer** and click **Next**.
- 4** On the **Do you have a Windows XP CD?** screen, click **I will use the wizard from the Windows XP CD** and click **Next**.
- 5** When the **Now go to your old computer** screen appears, go to your old or source computer. Do not click **Next** at this time.

To copy data from the old computer:

- 1** On the old computer, insert the *Windows XP Operating System* CD.
- 2** On the **Welcome to Microsoft Windows XP** screen, click **Perform additional tasks**.
- 3** Under **What do you want to do?**, click **Transfer files and settings**.
- 4** On the **Files and Settings Transfer Wizard** welcome screen, click **Next**.

- 5 On the **Which computer is this?** screen, click **Old Computer** and click **Next**.
- 6 On the **Select a transfer method** screen, click the transfer method you prefer.
- 7 On the **What do you want to transfer?** screen, select the items you want to transfer and click **Next**.

After the information has been copied, the **Completing the Collection Phase** screen appears.

- 8 Click **Finish**.

To transfer data to the new computer:

- 1 On the **Now go to your old computer** screen on the new computer, click **Next**.
- 2 On the **Where are the files and settings?** screen, select the method you chose for transferring your settings and files and click **Next**.

The wizard reads the collected files and settings and applies them to your new computer.

When all of the settings and files have been applied, the **Finished** screen appears.

- 3 Click **Finished** and restart the new computer.

## Setting Up a Printer

 **NOTICE:** Complete the operating system setup before you connect a printer to the computer.

See the documentation that came with the printer for setup information, including how to:

- Obtain and install updated drivers.
- Connect the printer to the computer.
- Load paper and install the toner or ink cartridge.
- Contact the printer manufacturer for technical assistance.

## Printer Cable

Your printer connects to your computer with either a USB cable or a parallel cable. Your printer may not come with a printer cable, so if you purchase a cable separately, ensure that it is compatible with your printer. If you purchased a printer cable at the same time you purchased your computer, the cable may arrive in the computer box.

### Connecting a Parallel Printer

- 1 Complete the operating system setup, if you have not already done so.
- 2 Shut down the computer (see "Turning Off Your Computer" on page 43).
- ➡ **NOTICE:** For best results, use a 3-m (10-ft) or shorter parallel cable.
- 3 Attach the parallel printer cable to the parallel connector on the computer and tighten the two screws. Attach the cable to the connector on the printer and snap the two clips into the two notches.

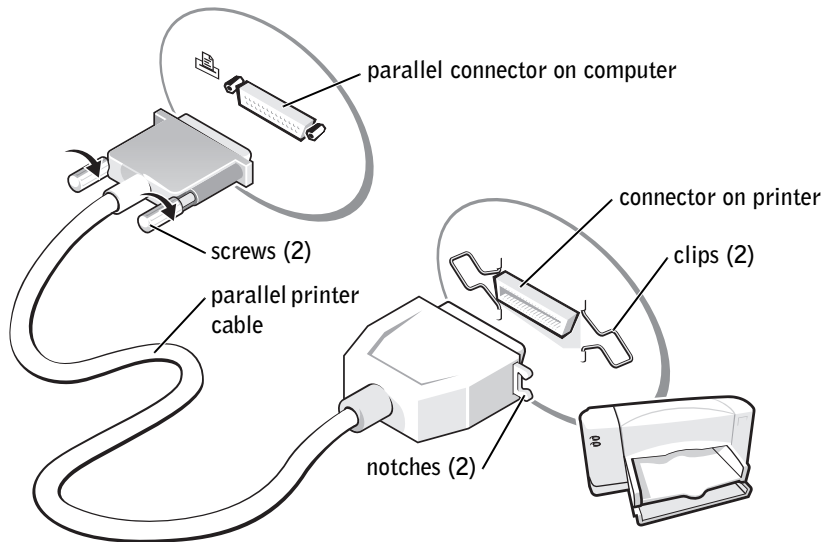

- 4 Turn on the printer and then turn on the computer. If the **Add New Hardware Wizard** window appears, click **Cancel**.

**NOTE:** You can connect USB devices while the computer is turned on.

- 5 Install the printer driver if necessary. See the documentation that came with your printer.

## Connecting a USB Printer

- 1 Complete the operating system setup if you have not already done so.
- 2 Install the printer driver if necessary. See the documentation that came with your printer.
- 3 Attach the USB printer cable to the USB connectors on the computer and the printer. The USB connectors fit only one way.

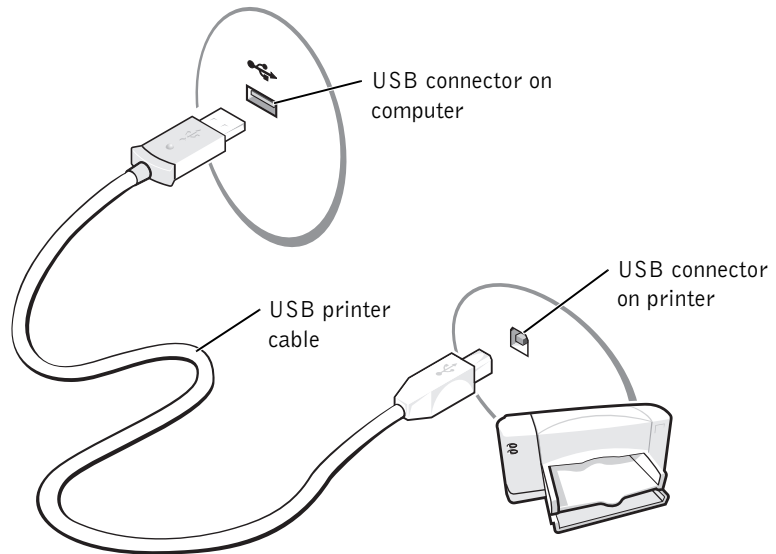

## Printer Problems

**CHECK THE PRINTER CABLE CONNECTIONS** — Ensure that the printer cable is properly connected to the computer.

**TEST THE ELECTRICAL OUTLET** — Ensure that the electrical outlet is working by testing it with another device, such as a lamp.



**ENSURE THAT THE PRINTER IS TURNED ON** — See the documentation supplied with the printer.

## VERIFY THAT WINDOWS® RECOGNIZES THE PRINTER

- 1 Click the Start button.
- 2 Click Control Panel.
- 3 Click Printers and Other Hardware.
- 4 Click View installed printers or fax printers. If the printer model is listed, right-click the printer icon.
- 5 Click Properties, and then click the Ports tab. Ensure that the Print to the following port(s): setting is LPT1 (Printer Port).

**REINSTALL THE PRINTER DRIVER** — See "Reinstalling Drivers and Utilities" on page 108.

## Setting Up the Docking Device to Connect to a Network

-  **NOTICE:** Do not install a network adapter or a network adapter/modem combination PC Card until you complete the docking device setup.
-  **NOTICE:** To prevent serious operating system problems, do not connect your computer to a docking device until the Windows operating system setup on the computer is complete.

 **NOTE:** A network adapter is also referred to as a network interface controller (NIC).

A docking device allows you to more fully integrate your portable computer into a desktop environment.

For instructions and details on setting up a docking device, refer to the documentation that came packaged with the device.

## Power Protection Devices

Several devices are available to protect against power fluctuations and failures:

- Surge protectors
- Line conditioners
- Uninterruptible power supplies (UPS)

## Surge Protectors

Surge protectors and power strips equipped with surge protection help to prevent damage to your computer from voltage spikes that can occur during electrical storms or following power interruptions. The level of protection is usually commensurate with the cost of the surge protector. Some surge protector manufacturers include warranty coverage for certain types of damage. Carefully read the device warranty when choosing a surge protector. A device with a higher joule rating offers more protection. Compare joule ratings to determine the relative effectiveness of different devices.

 **NOTICE:** Most surge protectors do not protect against power fluctuations or power interruptions caused by nearby lightning strikes. When lightning occurs in your area, disconnect the telephone line from the telephone wall jack and disconnect your computer from the electrical outlet.

Many surge protectors have a telephone jack for modem protection. See the surge protector documentation for modem connection instructions.

 **NOTICE:** Not all surge protectors offer network adapter protection. Disconnect the network cable from the network wall jack during electrical storms.

## Line Conditioners

 **NOTICE:** Line conditioners do not protect against power interruptions.

Line conditioners are designed to maintain AC voltage at a fairly constant level.

## Uninterruptible Power Supplies

 **NOTICE:** Loss of power while data is being saved to the hard drive may result in data loss or file damage.

A UPS protects against power fluctuations and interruptions. UPS devices contain a battery that provides temporary power to connected devices when AC power is interrupted. The battery charges while AC power is available. See the UPS manufacturer documentation for information on battery operating time and to ensure that the device is approved by Underwriters Laboratories (UL).

 **NOTE:** To ensure maximum battery operating time, connect only your computer to a UPS. Connect other devices, such as a printer, to a separate power strip that provides surge protection.

# Turning Off Your Computer

 **NOTICE:** To avoid losing data, turn off your computer by performing a Microsoft® Windows® operating system shutdown, as described next, rather than by pressing the power button.

**1** Save and close any open files, exit any open programs, click the **Start** button, and then click **Turn Off Computer**.

**2** In the **Turn off computer** window, click **Turn off**.

The computer turns off after the shutdown process finishes.

 **NOTE:** As an alternative to turning off your computer, you can set your computer to enter standby or hibernate mode.



SECTION 3

## **Using Batteries and Module Bay Devices**

---

Using a Battery

Power Problems

About the Module Bay

Removing and Installing Devices While the Computer Is  
Turned Off

Removing and Installing Devices While the Computer Is  
Running

# Using a Battery

## Battery Performance

 **NOTE:** Batteries for portable computers are covered only during the initial one-year period of the limited warranty for your computer. For more information about the Dell warranty for your computer, see "Limited Warranties and Return Policy" on page 159.

 **NOTE:** It is recommended that you connect your computer to an electrical outlet when writing to a CD.

Use a battery to power the computer when the computer is not connected to an electrical outlet. One battery is supplied as standard equipment in the battery bay.

Battery operating time varies depending on operating conditions. With average usage, you may expect from 3 to 4 hours from a single, fully charged battery. You can install an optional second battery in the module bay to significantly increase operating time. For more information about the second battery, see "About the Module Bay" on page 53.

Operating time is significantly reduced when you perform operations including, but not limited to, the following:

- Using optical drives, especially DVD and CD-RW drives
- Using wireless communications devices, PC Cards, or USB devices
- Using high-brightness display settings, 3D screen savers, or other power-intensive programs, such as 3D games
- Running the computer in maximum performance mode

You can check the battery charge on the bottom of the computer. You can also set power management options to alert you when the battery charge is low.

 **CAUTION:** Using an incompatible battery may increase the risk of fire or explosion. Replace the battery only with a compatible battery purchased from Dell. The lithium-ion battery is designed to work with your Dell™ computer. Do not use a battery from other computers with your computer.

 **CAUTION:** Do not dispose of batteries with household waste. When your battery no longer holds a charge, call your local waste disposal or environmental agency for advice on disposing of a lithium-ion battery. See the battery disposal instructions in "Battery Disposal" on page 17.



 **CAUTION: Misuse of the battery may increase the risk of fire or chemical burn. Do not puncture, incinerate, disassemble, or expose the battery to temperatures above 65°C (149°F). Keep the battery away from children. Handle damaged or leaking batteries with extreme care. Damaged batteries may leak and cause personal injury or equipment damage.**

## Checking the Battery Charge

The Dell QuickSet battery meter, Microsoft® Windows® power meter window and  icon, the battery charge gauge, and the low-battery warning provide information on the battery charge.

For more information about checking the charge on the second battery, see "About the Module Bay" on page 53.

### Dell QuickSet Battery Meter

Press   to display the QuickSet Battery Meter.

The **Battery Meter** screen displays status, charge level, and charge completion time for the primary and secondary batteries in your computer.

The following icons appear in the **Battery Meter** screen:



- The computer is running on battery power.
- The battery is discharging or idle.



- The computer is connected to an electrical outlet and running on AC power.
- The battery is charging.





- The computer is connected to an electrical outlet and running on AC power.
  - The battery is discharging, idle, or charging.
- 

For more information about QuickSet, right-click the  icon in the taskbar, and click **Help**.

 **NOTE:** Dell recommends that you connect your computer to an electrical outlet when writing to a CD.

### Microsoft Windows Power Meter

The Windows power meter indicates the remaining battery charge. To check the power meter, double-click the  icon on the taskbar. For more information on the **Power Meter** tab, see the *Tell Me How* help file. To access the help file, see "Accessing Help" on page 98.

If the computer is connected to an electrical outlet, a  icon appears.

### Charge Gauge

Press the status button on the battery charge gauge to illuminate the charge-level lights. Each light represents approximately 20 percent of the total battery charge. For example, if the battery has 80 percent of its charge remaining, four of the lights are on. If no lights appear, the battery has no charge.



### Low-Battery Warning



**NOTICE:** To avoid losing or corrupting data, save your work immediately after a low-battery warning. Then connect the computer to an electrical outlet, or install a second battery in the module bay. If the battery runs completely out of power, hibernate mode begins automatically.

A low-battery warning occurs when the battery charge is approximately 90 percent depleted. The computer beeps once, indicating that minimal battery operating time remains. During that time, the speaker beeps periodically. If two batteries are installed, the low-battery warning means that the combined charge of both batteries is approximately 90 percent depleted. The computer enters hibernate mode when the battery charge is at a critically low level. For more information on low-battery alarms, see the *Tell Me How* help file. To access the help file, see "Accessing Help" on page 98.

## Charging the Battery

When you connect the computer to an electrical outlet or install a battery while the computer is connected to an electrical outlet, the computer checks the battery charge and temperature. If necessary, the AC adapter then charges the battery and maintains the battery charge.

If the battery is hot from being used in your computer or being in a hot environment, the battery may not charge when you connect the computer to an electrical outlet.

Disconnect the computer from the electrical outlet and allow the computer and the battery to cool to room temperature. Then connect the computer to an electrical outlet to continue charging the battery.

For more information on resolving problems with a battery, see "Power Problems" on page 52.

## Removing a Battery

For more information about removing the second battery, see "About the Module Bay" on page 53.

 **CAUTION:** Before performing these procedures, turn off the computer, disconnect it from the electrical outlet, and disconnect the modem from the telephone wall jack.

 **NOTICE:** If you choose to replace the battery with the computer in standby mode, you have up to 90 seconds to complete the battery replacement before the computer shuts down and loses any unsaved data.

- 1 Ensure that the computer is turned off, disconnected from an electrical outlet, and disconnected from the telephone wall jack.

 **NOTE:** The AC adapter charges a completely discharged battery in approximately 1 hour with the computer turned off. Charge time is longer with the computer turned on. You can leave the battery in the computer as long as you like. The battery internal circuitry prevents the battery from overcharging.

- 2 If the computer is connected to a docking device (docked), undock it. See the documentation that came with your docking device for instructions.
- 3 Slide and hold the battery-bay latch release on the bottom of the computer, and then remove the battery from the bay.

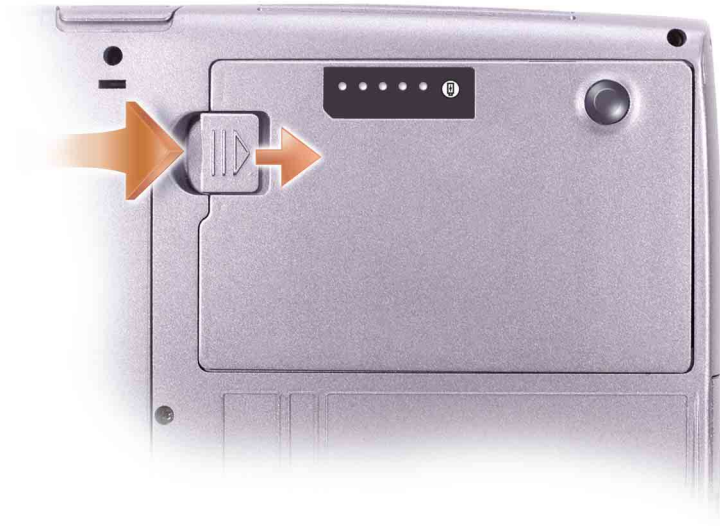

### **Installing a Battery**

Slide the battery into the bay until the latch release clicks.

For more information about installing the second battery, see "About the Module Bay" on page 53.

## Removing and Installing a Reserve Battery

- 1 Remove the battery (see page 49).
- 2 Remove the reserve battery cover.



- 3 Pull the reserve battery out of its compartment, and disconnect the reserve battery cable from the connector.

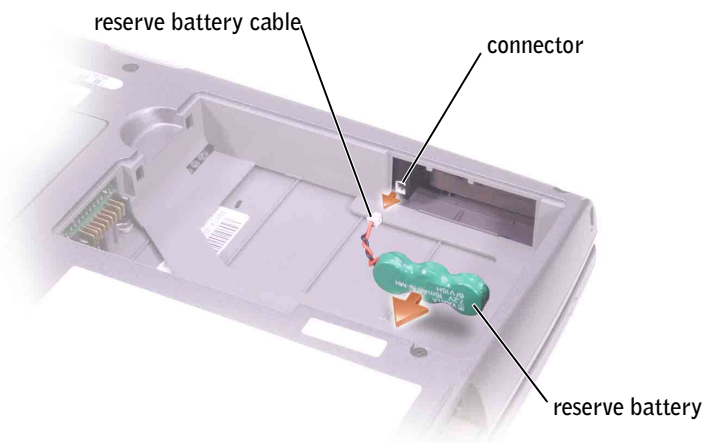

- 4 Connect the reserve battery cable to the connector in the reserve battery compartment.
- 5 Place the reserve battery in the compartment, and replace the reserve battery cover.



### Storing a Battery

Remove the battery when you store your computer for an extended period of time. A battery discharges during prolonged storage. After a long storage period, recharge the battery fully before you use it.

## Power Problems

**CHECK THE POWER LIGHT** — When the power light is lit or blinking, the computer has power. If the power light is blinking, the computer is in standby mode—press the power button to exit standby mode. If the light is off, press the power button to turn on the computer.

**CHARGE THE BATTERY** — The battery charge may be depleted.

- 1 Reinstall the battery.
- 2 Use the AC adapter to connect the computer to an electrical outlet.
- 3 Turn on the computer.

**CHECK THE BATTERY STATUS LIGHT** — If the battery status light flashes orange or is a steady orange, the battery charge is low or depleted. Connect the computer to an electrical outlet.

If the battery status light flashes green and orange, the battery is too hot to charge. Turn off the computer (see "Turning Off Your Computer" on page 43), disconnect the computer from the electrical outlet, and then let the battery and computer cool to room temperature.

If the battery status light rapidly flashes orange, the battery may be defective. Contact Dell (see "Contacting Dell" on page 139).

**TEST THE ELECTRICAL OUTLET** — Ensure that the electrical outlet is working by testing it with another device, such as a lamp.

**CHECK THE AC ADAPTER** — Check the AC adapter cable connections. If the AC adapter has a light, ensure that the light is on. Make sure that the AC adapter is a Dell AC adapter that is designed to work with your computer.

**CONNECT THE COMPUTER DIRECTLY TO AN ELECTRICAL OUTLET** —

Bypass power protection devices, power strips, and the extension cable to verify that the computer turns on.

**ELIMINATE POSSIBLE INTERFERENCE** — Turn off nearby fans, fluorescent lights, halogen lamps, or other appliances.

**ADJUST THE POWER PROPERTIES** — See the *Tell Me How* help file or search for the keyword *standby* in the Help and Support Center. To access help, see "Accessing Help" on page 98.

**RESET THE MEMORY MODULES** — If the computer power light turns on but the display remains blank, reseal the memory modules (see "Adding Memory" on page 118).

## About the Module Bay

You can install devices such as a floppy drive, CD drive, CD-RW drive, DVD drive, CD-RW/DVD drive, DVD+RW, second battery, or second hard drive in the module bay.

Your Dell™ computer ships with an optical drive installed in the module bay. However, the device screw is not installed in the optical drive but packaged separately. When you install your device in the module bay, you can install the device screw.

 **NOTE:** See the *Tell Me How* help file for information on standby mode. To access the help file, see "Accessing Help" on page 98.

 **NOTE:** You do not need to install the device screw unless you want to secure the module inside the computer for security purposes.

## Checking the Charge on the Second Battery

Before you install a second battery, press the status button on the battery charge gauge to illuminate the charge-level lights. Each light represents approximately 20 percent of the total battery charge. For example, if the battery has 80 percent of its charge remaining, four of the lights are on. If no lights appear, the battery has no charge.

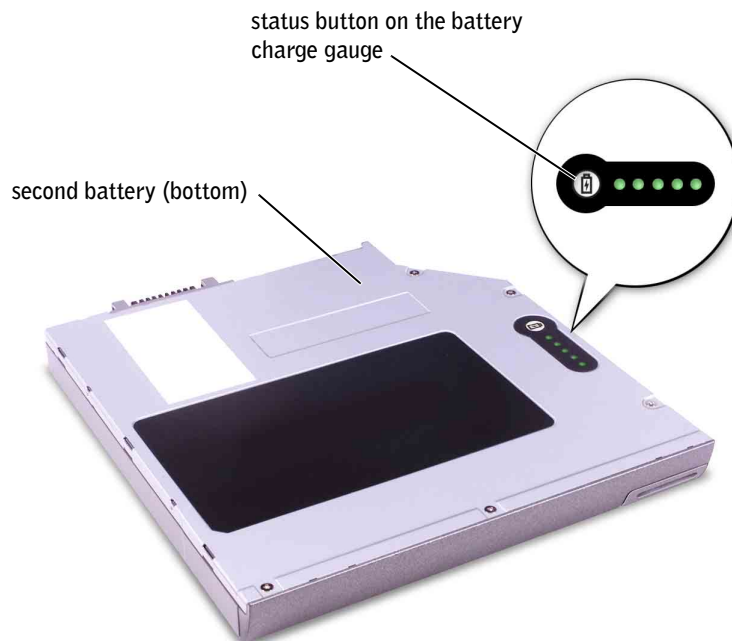

## Removing and Installing Devices While the Computer Is Turned Off

**NOTE:** If the device screw is not installed, you can remove and install devices while the computer is running and connected to a docking device (docked).

Your computer ships with an optical drive installed in the module bay. However, the device screw is not installed in the optical drive but packaged separately. When you install your device in the module bay, you can install the device screw.

## If the Device Screw Is Not Installed

**▶ NOTICE:** To prevent damage to devices, place them in a safe, dry place when they are not installed in the computer. Avoid pressing down on them or placing heavy objects on top of them.

- 1 Press the device latch release so that the latch release pops out.

**✍ NOTE:** You do not need to install the device screw unless you want to secure the module inside the computer for security purposes.



- 2 Pull the device by the latch release to remove the device from the module bay.



- 3 Insert the new device into the bay, push the device until you feel a click, and push the device latch release in so that it is flush with the computer.

### If the Device Screw Is Installed

- 1 Save and close any open files, exit any open programs, and then shut down the computer.
  - 2 If the computer is connected to a docking device (docked), undock it. See the documentation that came with your docking device for instructions.
- NOTICE:** To prevent damage to devices, place them in a safe, dry place when they are not installed in the computer. Avoid pressing down on them or placing heavy objects on top of them.
- 3 Close the display and turn the computer over.

- 4 Use a #1 Phillips screwdriver to remove the device screw from the bottom of the computer.



- 5 Press the device latch release so that the latch release pops out.
- 6 Pull the device by the latch release to remove the device from the module bay.



 **NOTE:** If the device screw is not installed, you can remove and install devices while the computer is running and connected to a docking device (docked).

 **NOTE:** You do not need to install the device screw unless you want to secure the module inside the computer for security purposes.

-  **NOTICE:** Insert devices into the module bay before you dock and turn on the computer.
- 7 Insert the new device into the bay, push the device until you feel a click, and push the device latch release in so that it is flush with the computer.
- 8 Replace the device screw.
- 9 Turn on the computer.

## Removing and Installing Devices While the Computer Is Running

Your computer ships with an optical drive installed in the module bay. However, the device screw is not installed in the optical drive but packaged separately. When you install your device in the module bay, you can install the device screw.

### If the Device Screw Is Not Installed

- 1 Double-click the **Safely Remove Hardware** icon on the taskbar.
  - 2 Click **Stop** and wait for the operating system to confirm that the device has stopped.
  - 3 Click the device you want to eject.
-  **NOTICE:** To prevent damage to devices, place them in a safe, dry place when they are not installed in the computer. Avoid pressing down on them or placing heavy objects on top of them.

- 4 Press the device latch release so that the latch release pops out.



- 5 Pull the device by the latch release to remove the device from the module bay.



- 6 Insert the new device into the bay, push the device until you feel a click, and push the device latch release in so that it is flush with the computer. Windows XP automatically recognizes the new device.
- 7 If necessary, enter your password to unlock your computer.

### If the Device Screw Is Installed

- 1 Double-click the **Safely Remove Hardware** icon on the taskbar.
  - 2 Click the device you want to eject.
  - 3 If the computer is connected to a docking device (docked), undock it. See the documentation that came with your docking device for instructions.
- NOTICE:** To prevent damage to devices, place them in a safe, dry place when they are not installed in the computer. Avoid pressing down on them or placing heavy objects on top of them.
- 4 Use a #1 Phillips screwdriver to remove the device screw from the bottom of the computer.



- 5 Press the device latch release so that the latch release pops out.
- 6 Pull the device by the latch release to remove the device from the module bay.



- 7 Insert the new device into the bay, push the device until you feel a click, and push the device latch release in so that it is flush with the computer. Windows XP automatically recognizes the new device.
- 8 If necessary, enter your password to unlock your computer.



SECTION 4

## **Using the Keyboard and Touch Pad**

---

Numeric Keypad

Keyboard Shortcuts

Customizing the Touch Pad

Touch Pad or Mouse Problems

External Keyboard Problems

Unexpected Characters

## Numeric Keypad



**NOTE:** When you connect an external keyboard or keypad to the computer, the keypad is disabled.

**NOTE:** You can change options for using the numeric keypad in the system setup program.

The keypad numbers and symbols are marked in blue on the right side of the keypad keys. To type a number or symbol, press **Num Lk** to enable the numeric keypad, and then hold down **Fn** and press the desired key.

# Keyboard Shortcuts

## System Functions



Opens the **Windows Task Manager** window.



Enables and disables the numeric keypad.



Enables and disables the scroll lock.

## Battery



Displays the Dell™ QuickSet Battery Meter.

## CD or DVD Tray



Ejects the tray out of the drive.

## Display Functions



Switches the video image to the next display in the following sequence: the integrated display only, the integrated display and an external CRT monitor simultaneously, an external CRT monitor only, the integrated display and an external DVI monitor simultaneously, and an external DVI monitor only.



Increases brightness on the integrated display only (not on an external monitor).



Decreases brightness on the integrated display only (not on an external monitor).

## Radios (Including Wireless Networking and Bluetooth™)



Enables and disables radios, including wireless networking and Bluetooth.

## Power Management



Activates the power management mode of your choice. You can program this keyboard shortcut on the **Advanced** tab in the **Power Options Properties** window.

## Speaker Functions

If no sound comes from the speakers, press and adjust the volume.



Increases the volume of the integrated speakers and external speakers, if attached.



Decreases the volume of the integrated speakers and external speakers, if attached.



Enables and disables the integrated speakers and external speakers, if attached.

## Microsoft® Windows® Logo Key Functions



Minimizes all open windows.



Maximizes all windows.



Runs Windows Explorer.



Opens the **Run** dialog box.



Opens the **Search Results** dialog box.



Opens the **Search Results-Computer** dialog box (if the computer is connected to a network).



Opens the **System Properties** dialog box.

To adjust keyboard operation, such as the character repeat rate, open the Control Panel, and click **Printers and Other Hardware**.

The touch pad detects the pressure and movement of your finger to allow you to move the cursor on the display. Use the touch pad and touch pad buttons as you would use a mouse.

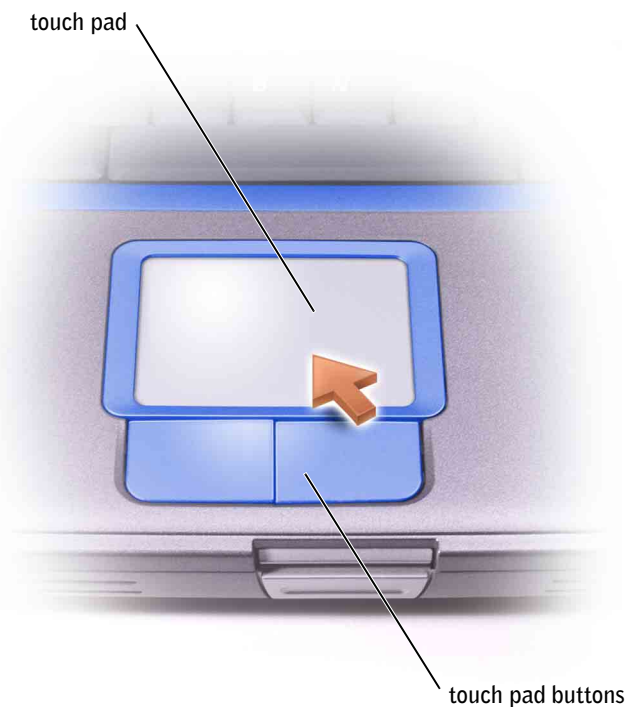

- To move the cursor, lightly slide your finger over the touch pad.
- To select an object, lightly tap once on the surface of the touch pad or use your thumb to press the left touch-pad button.
- To select and move (or drag) an object, position the cursor on the object and tap down-up-down on the touch pad. On the second down motion, leave your finger on the touch pad and move the selected object by sliding your finger across the surface.
- To double-click an object, position the cursor on the object and then tap twice on the touch pad, or use your thumb to press the left touch-pad button twice.

## Customizing the Touch Pad

You can disable the touch pad or adjust their settings by using the **Mouse Properties** window.

- 1 Click the **Start** button, click **Control Panel**, and then double-click the **Mouse** icon.
- 2 On the **Mouse Properties** window:
  - Click the **Device Select** tab to disable the touch pad.
  - Click the **Pointer** tab to adjust touch pad settings.
- 3 Select the desired settings and click **Apply**.
- 4 Click **OK** to save the settings and close the window.

## Touch Pad or Mouse Problems

### **CHECK THE TOUCH PAD SETTINGS** —

- 1 Click the **Start** button, click **Control Panel**, and then click **Printers and Other Hardware**.
- 2 Click **Mouse**.
- 3 Try adjusting the settings.

### **TO VERIFY THAT THE PROBLEM IS WITH THE MOUSE, CHECK THE TOUCH PAD** —

- 1 Shut down the computer (see "Turning Off Your Computer" on page 43).
- 2 Disconnect the mouse.
- 3 Turn on the computer.
- 4 At the Windows desktop, use the touch pad to move the cursor around, select an icon, and open it.

If the touch pad operates correctly, the mouse may be defective.

**REINSTALL THE TOUCH PAD DRIVER** — See "Reinstalling Drivers and Software" on page 115.

## External Keyboard Problems

**CHECK THE KEYBOARD CABLE** — Shut down the computer (see "Turning Off Your Computer" on page 43). Disconnect the keyboard cable and check it for damage.

If you are using a keyboard extension cable, disconnect it and connect the keyboard directly to the computer.

### CHECK THE EXTERNAL KEYBOARD —

- 1 Turn off the computer, wait 1 minute, and turn it on again.
- 2 Verify that the numbers, capitals, and scroll lock lights on the keyboard blink during the boot routine.
- 3 From the Windows® desktop, click the **Start** button, point to **All Programs**, point to **Accessories**, and click **Notepad**.
- 4 Type some characters on the external keyboard and verify that they appear on the display.

If you cannot verify these steps, you may have a defective external keyboard.

### TO VERIFY THAT THE PROBLEM IS WITH THE EXTERNAL KEYBOARD, CHECK THE INTEGRATED KEYBOARD —

- 1 Turn off the computer.
- 2 Disconnect the external keyboard.
- 3 Turn on the computer.
- 4 From the Windows desktop, click the **Start** button, point to **All Programs**, point to **Accessories**, and click **Notepad**.
- 5 Type some characters on the external keyboard and verify that they appear on the display.

If the characters appear now but did not with the external keyboard, you may have a defective external keyboard. Contact Dell (see "Contacting Dell" on page 139).

## Unexpected Characters

### DISABLE THE NUMERIC KEYPAD —

Press  to disable the numeric keypad if numbers are displayed instead of letters. Verify that the numbers lock light is not lit.

 **NOTE:** When you attach an external keyboard, the integrated keyboard remains fully functional.



SECTION 5

## **Using CDs, DVDs, and Other Multimedia**

---

Using CDs and DVDs

CD and DVD Problems

Sound and Speaker Problems

Copying CDs

Connecting a Television to the Computer

## Using CDs and DVDs

For information about using CDs and DVDs in your computer, see the *Tell Me How* help file. To access the help file, see "Accessing Help" on page 98.

## CD and DVD Problems

### If you cannot play a CD or DVD

 **NOTE:** Because of different worldwide file types, not all DVD titles work in all DVD drives.

High-speed CD drive vibration is normal and may cause noise. This noise does not indicate a defect with the drive or the CD.

**ENSURE THAT WINDOWS® RECOGNIZES THE DRIVE** — Click the **Start** button and click **My Computer**. If the drive is not listed, perform a full scan with your antivirus software to check for and remove viruses. Viruses can sometimes prevent Windows from recognizing the drive. Insert a bootable disk and restart the computer. Verify that the  light is blinking, indicating normal operation.

**TRY ANOTHER DISC** — Insert another disc to eliminate the possibility that the original disc is defective.

**ENSURE THAT THE CD IS SNAPPED TO THE SPINDLE.**

**ADJUST THE WINDOWS VOLUME CONTROL** — Double-click the speaker icon in the lower-right corner of your screen. Ensure that the volume is turned up and that the sound is not muted.

**REINSTALL THE DRIVE** —

- 1 Save and close any open files, exit any open programs, and shut down the computer.
- 2 Remove the drive. See "Using the Module Bay" in the *Tell Me How* help file for instructions. To access the help file, see "Accessing Help" on page 98.
- 3 Reinstall the drive.
- 4 Turn on the computer.

**CLEAN THE DRIVE OR DISC** — See "Cleaning Your Computer" in the *Tell Me How* help file for instructions. To access the help file, see "Accessing Help" on page 98.

### If you cannot eject the CD, CD-RW, or DVD drive tray

- 1 Ensure that the computer is shut down and turned off (see page 43).
- 2 Straighten a paper clip and insert one end into the eject hole at the front of the drive; push firmly until the tray is partially ejected.
- 3 Gently pull out the tray until it stops.

### **If you hear an unfamiliar scraping or grinding sound**

- Ensure that the sound is not caused by the program that is running.
- Ensure that the disk or disc is inserted properly.

### **If the CD-RW drive stops writing**

**DISABLE STANDBY MODE IN WINDOWS BEFORE WRITING TO A CD-RW** — Search for the keyword *standby* in the Help and Support Center. To access help, see "Accessing Help" on page 98.

**CHANGE THE WRITE SPEED TO A SLOWER RATE** — See the help files for your CD creation software.

**EXIT ALL OTHER OPEN PROGRAMS** — Exiting all other open programs before writing to the CD-RW may alleviate the problem.

## **Sound and Speaker Problems**

### **If you have a problem with integrated speakers**

**ADJUST THE WINDOWS<sup>®</sup> VOLUME CONTROL** — Double-click the speaker icon in the lower-right corner of your screen. Ensure that the volume is turned up and that the sound is not muted. Adjust the volume, bass, or treble controls to eliminate distortion.

**ADJUST THE VOLUME USING THE VOLUME CONTROL BUTTONS** — Press the volume control buttons and mute button, which are located above the keyboard.

**REINSTALL THE SOUND (AUDIO) DRIVER** — See "Reinstalling Drivers and Software" on page 115.

### **If you have a problem with external speakers**

**CHECK THE SPEAKER CABLE CONNECTIONS** — See the setup diagram supplied with the speakers.

**TEST THE ELECTRICAL OUTLET** — Ensure that the electrical outlet is working by testing it with another device, such as a lamp.

**ENSURE THAT THE SPEAKERS ARE TURNED ON** — See the setup diagram supplied with the speakers.

**ADJUST THE WINDOWS VOLUME CONTROL** — Double-click the speaker icon in the lower-right corner of your screen. Ensure that the volume is turned up and that the sound is not muted. Adjust the volume, bass, or treble controls to eliminate distortion.



**NOTE:** The volume control in some MP3 players overrides the Windows volume setting. If you have been listening to MP3 songs, make sure that you did not turn the player volume down or off.

**TEST THE SPEAKERS** — Plug the speaker audio cable into the line-out connector on the computer. Ensure that the headphone volume control is turned up. Play a music CD.

**RUN THE SPEAKER SELF-TEST** — Some speaker systems have a self-test button on the subwoofer. See the speaker documentation for self-test instructions.

**ELIMINATE POSSIBLE INTERFERENCE** — Turn off nearby fans, fluorescent lights, or halogen lamps to check for interference.

**REINSTALL THE SOUND (AUDIO) DRIVER** — See "Reinstalling Drivers and Software" on page 115.

## Copying CDs

This section applies only to computers that have a CD- or DVD-recording device.

The information in this section is based on the Roxio Easy CD Creator Basic documentation that came with your computer. See "Using Easy CD Creator Basic" on page 75 for instructions on how to locate that documentation.

To burn CDs, you need to use CD-burner software. Roxio Easy CD Creator Basic is your computer's CD-burner software. The software includes the following project programs that enable you to record specialty CDs for different types of uses:

- DirectCD allows you to format a blank CD-R or CD-RW disc so that you can use Microsoft® Windows® Explorer to drag and drop data files to the CD-RW drive. You can use a DirectCD-formatted CD-RW disc like another hard drive on your computer because CD-RW discs are fully rewritable (CD-R discs can be used with DirectCD, but that media type has overwriting limitations—see "Using Blank CD-R Discs or Blank CD-RW Discs" on page 75 for recording media differences).
- MusicCD allows you to burn custom music CDs.
- DataCD allows you to copy a variety of your documents, such as spreadsheet or accounting files, to a CD for permanent storage.

 **NOTE:** To "burn" a CD means to copy or create your own custom CD. Ensure that you follow all copyright laws when you create CDs.

 **NOTE:** The information in this section also applies to using Easy CD Creator Basic with a DVD+RW or a DVD+R drive.

- Disc Copier allows you to make a backup copy of almost any type of CD. This program allows you to make a copy of a CD for everyday use so that you can archive and save the original copy. (Disc Copier is titled "CD Copier" in some versions of Roxio CD Creator Basic.)

All four project programs are available on the Easy CD Creator Basic **Select a Project** menu screen. To view the **Select a Project** menu screen, click the **Start** button, point to **All Programs**→ **Roxio Easy CD Creator**, and then click **Project Selector**.

### Using Easy CD Creator Basic

See the Easy CD Creator Basic documentation for instructions on how to use the program, information about different recording techniques, and CD media limitations. The Easy CD Creator Basic documentation is located in the Help and Support Center (see "Accessing Help" on page 98). The documentation is also provided on the Roxio reinstallation CD, which is included with your computer. Each Easy CD Creator Basic project program also has thorough online help files.

### Using Blank CD-R Discs or Blank CD-RW Discs

Your CD-RW drive writes to two different types of recording media—CD-R and CD-RW discs. Use blank CD-R (CD-Recordable) disks to record music or permanently store data files. After creating a CD-R disc, you cannot write to that disc again without changing your method of recording (see the Roxio documentation for more information). Use blank CD-RW (CD-ReWritable) discs when you want to write, erase, rewrite, and update your files onto CDs.

### Helpful Tips

- You must use the Easy CD Creator Basic project programs to copy and record all music and data CDs. You can use Windows Explorer to drag and drop files to a CD-R or CD-RW disc only after you first use DirectCD to format the disc.
- You must use CD-R discs to burn music CDs that you want to play in regular stereos. CD-RW discs do not play in most home or car stereos.

 **NOTE:** Some music and game CDs are copy-protected. If you have a CD that cannot be copied, you must use the original CD for everyday use.

- If you want to copy files from the Internet or files from a floppy or Zip drive, copy those files to your hard drive first, and then burn your CD. Your CD-RW drive requires a steady stream of data to properly record. Direct Internet downloads, floppy drives, and Zip drives may not be able to provide a steady data stream to your CD-RW drive.
- Music MP3 files can be played only on MP3 players or on computers that have MP3 software installed.
- Ensure that you set the sampling rate to at least 128 Kbps when you burn MP3 files to a CD. Otherwise, recording errors may occur.
- Do not burn a blank CD-R or CD-RW disc to its maximum capacity; for example, do not copy a 650-MB file to a 650-MB blank CD. The CD-RW drive needs 1 or 2 MB of the blank CD to finalize the recording.
- Use a blank CD-RW disc to practice CD recording until you are familiar with CD recording techniques. If you make a mistake, you can erase the CD-RW disc and try again. You can also use blank CD-RW discs to test music file projects before you record the project permanently to a blank CD-R disc.
- See the Roxio support website at [support.roxio.com](http://support.roxio.com) for additional helpful tips.

## How to Copy a CD



**NOTE:** If you have a DVD/CD-RW combo drive and you experience recording problems, first check for available software patches on the Dell Support website at [support.dell.com](http://support.dell.com) and if necessary, the Roxio support website at [support.roxio.com](http://support.roxio.com).

The procedure assumes that your computer is equipped with a single CD-RW drive (without an additional CD drive). If your computer is equipped with both types of drives, see the Roxio documentation for instructions on how to copy CDs from a CD drive to a CD-RW drive.

- 1 Click the **Start** button, point to **All Programs**→**Roxio Easy CD Creator**, and then click **Project Selector**.

The **Select a Project** window appears.

- 2 Click **Disc Copier**. (Disc Copier is titled "CD Copier" in some versions of Easy CD Creator Basic.)

The **Disc Copier** window appears and displays your CD-RW drive in the **Copy from** and the **Record to** lists.

- 3 Insert the source CD that you want to copy into the CD-RW drive.  
The Disc Copier project program briefly checks the source CD in the CD-RW drive to ensure that it is a readable CD.
- 4 Click **Copy**.  
Depending on the size of the files that are being copied, the copy process may take a few minutes.
- 5 After the source CD is copied, remove the source CD from the CD-RW drive tray.  
The CD-RW drive tray opens automatically after the source CD is copied.
- 6 Insert a blank CD into the CD-RW drive and close the tray.  
The recording starts automatically.
- 7 After the recording completes, click **OK**.

## Connecting a Television to the Computer

Your computer has an S-video TV-out connector that enables you to connect the computer to a television. Using a commercially available S-video cable or composite video cable, you can connect the computer to a television in one of two ways:

- S-video (for a television with S-video input)
- Composite video (for a television with only a composite video input; also uses the Dell-supplied composite TV-out adapter cable)

The audio connector on the side of the computer enables you to connect the computer to your television or audio device, using a commercially available audio cable.

When you complete the cable connection, see "Enabling the Display Settings for a Television" on page 82 to ensure that the computer recognizes and works properly with the television.

 **NOTE:** Video and audio cables for connecting your computer to a television are not included with your computer. Cables may be purchased at most consumer electronics stores.

 **NOTE:** Diagrams for each connection combination appear at the beginning of each subsection to help you determine which method you should use.

## S-Video Connection

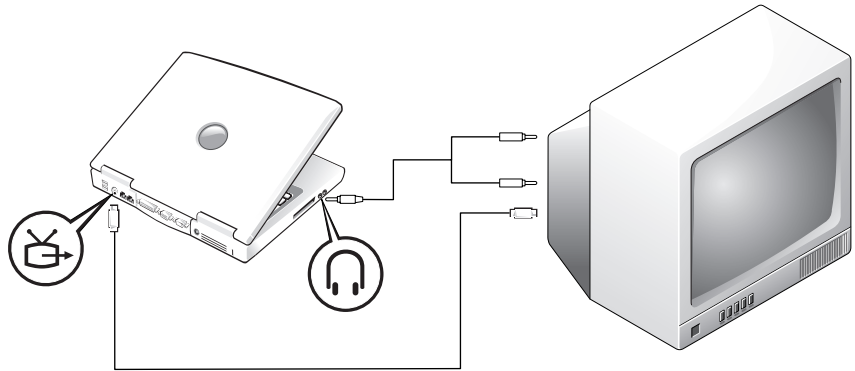

Before you begin, ensure that you have the following cables:

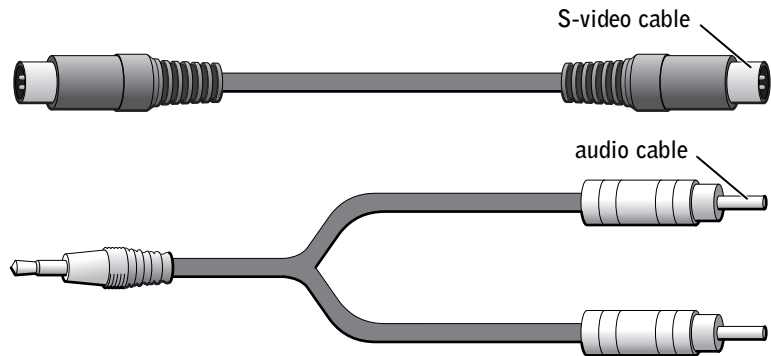

- 1 Shut down the computer and the television and/or audio device you want to connect.
- 2 Plug one end of the S-video cable into the S-video connector on the computer.

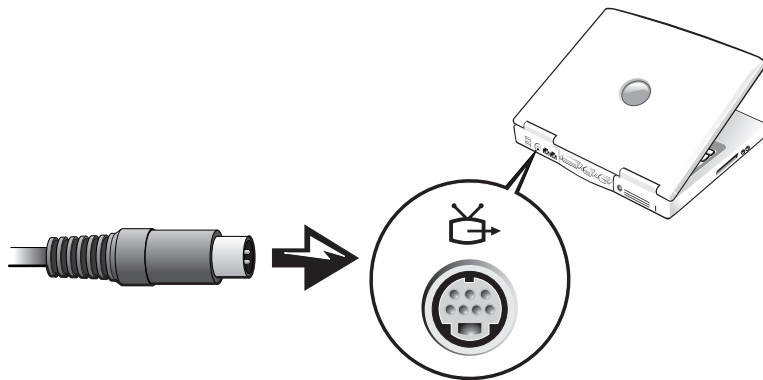

- 3** Plug the other end of the S-video cable into your television.
- 4** Plug the single-connector end of the audio cable into the headphone connector on your computer.

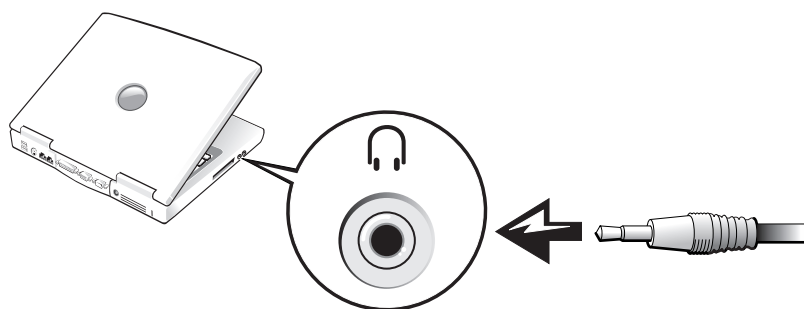

- 5** Plug the two RCA connectors on the other end of the audio cable into the audio input connectors on your television or audio device.
- 6** Turn on the television, turn on any audio device you connected, and then turn on the computer.
- 7** See "Enabling the Display Settings for a Television" on page 82 to ensure that the computer recognizes and works properly with the television.

## Composite Video Connection

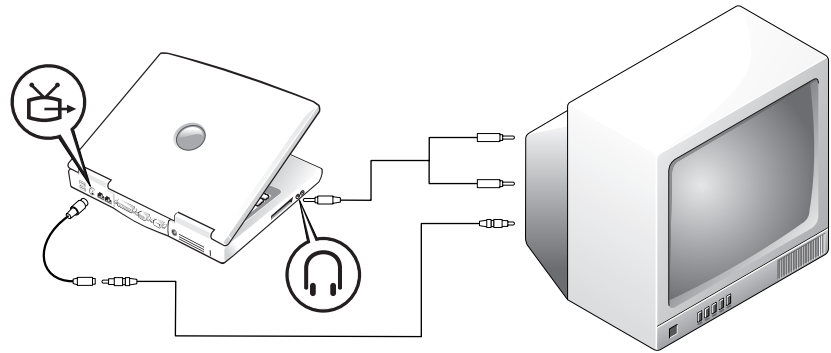

To connect the computer to a television that has a composite video input only, Dell provides a composite TV-out adapter cable. Before you begin, ensure that you have the following cables:

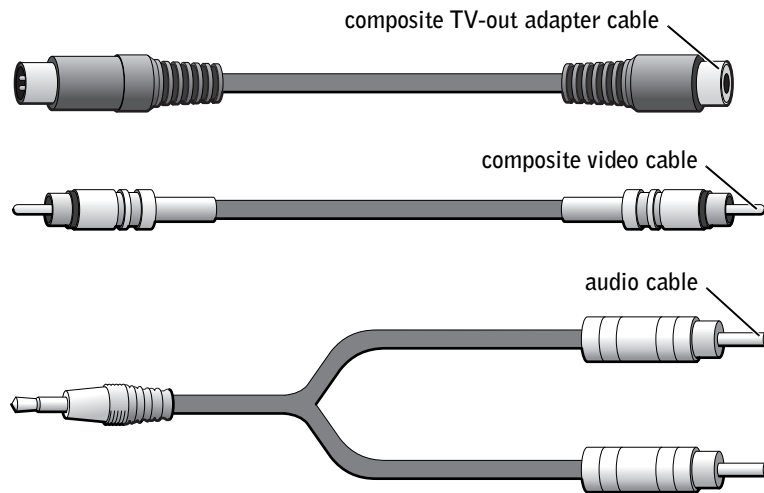

- 1 Turn off the computer and the television and/or audio device you want to connect.
- 2 Connect the composite TV-out adapter cable to the S-video TV-out connector on the computer.

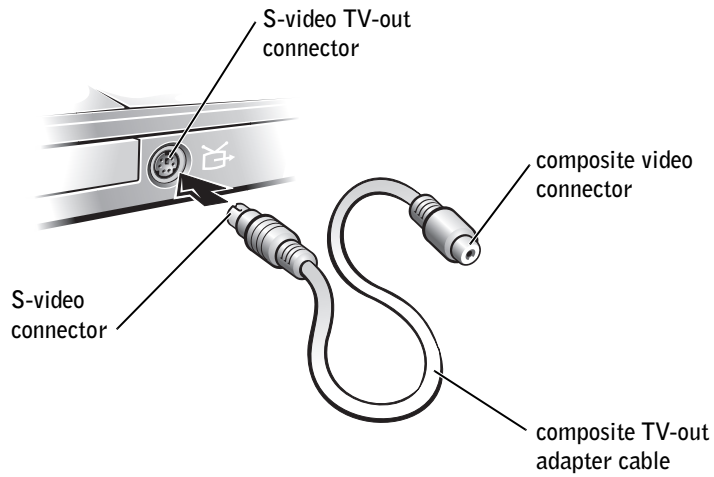

- 3 Plug one end of the composite video cable into the composite video connector on the composite TV-out adapter cable.



- 4 Plug the other end of the composite video cable into the composite video connector on the television.
- 5 Plug the single-connector end of the audio cable into the headphone connector on the computer.

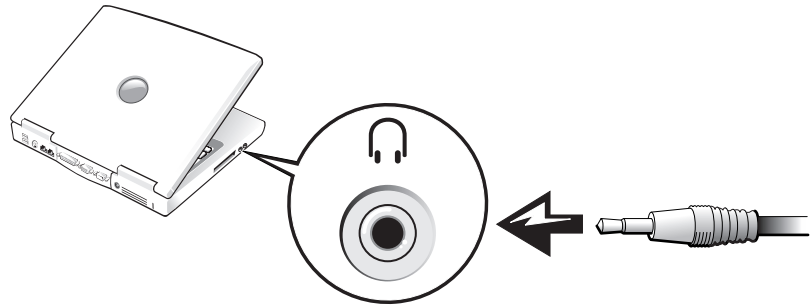

- 6 Plug the two RCA connectors on the other end of the audio cable into the audio input connectors on your television or audio device.

## Enabling the Display Settings for a Television

### ATI Video Controller

**NOTE:** Ensure that you properly connect the television before you enable the display settings.

- 1 To open the **Control Panel** window, click the **Start** button and then click the **Control Panel** icon.
- 2 Double-click the **Display** icon, click the **Settings** tab, and then click **Advanced**.
- 3 Click the **Displays** tab.
- 4 Click the upper-left corner of the **TV** button to enable the television.
- 5 To play a DVD on the television, click the small "primary" button (resembles a bull's-eye) at the bottom-left under the **TV** picture.
- 6 Click **Apply**.
- 7 Click **Yes** to keep the new settings.
- 8 Click **OK**.

**NOTE:** Various programs access the hardware in different ways. You may or may not need to click the primary button for operations other than playing DVDs.

DVD video is visible only on the display that is set to primary. While the DVD is playing, the DVD player window on your computer display is blank or (if the DVD player window is set to full-screen mode) the entire computer display screen is blank.

SECTION 6

## **Setting Up a Home and Office Network**

---

Connecting to a Network Adapter

Network Setup Wizard

Network Problems

Connecting to Wireless Local Area Networks

## Connecting to a Network Adapter

Before you connect your computer to a network, the computer must have a network adapter installed and a network cable connected to it.

To connect a network cable:

- 1 Connect the network cable to the network adapter connector on the back of your computer.
- 2 Connect the other end of the network cable to a network connection device, such as a network wall jack.

 **NOTE:** Insert the cable until it clicks into place, and then gently pull it to ensure that it is secure.

 **NOTE:** Do not use a network cable with a telephone wall jack.

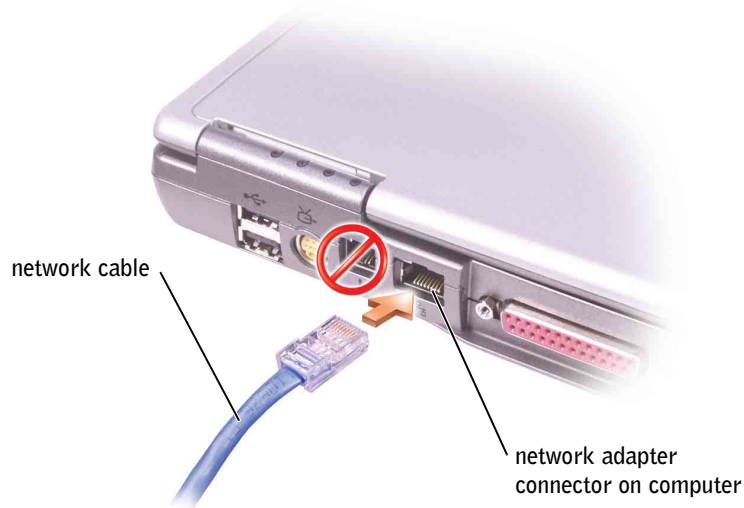

## Network Setup Wizard

The Microsoft® Windows® XP operating system provides a Network Setup Wizard to guide you through the process of sharing files, printers, or an Internet connection between computers in a home or small office.

- 1 Click the **Start** button, point to **All Programs**→ **Accessories**→ **Communications**, and then click **Network Setup Wizard**.

- 2 On the welcome screen, click **Next**.
- 3 Click **Checklist for creating a network**.
- 4 Complete the checklist and required preparations, and return to the Network Setup Wizard.
- 5 Follow the instructions on the screen.

 **NOTE:** Selecting the connection method **This computer connects directly to the Internet** enables the integrated firewall provided with Windows XP.

## Network Problems

**CHECK THE NETWORK CABLE CONNECTOR** — Ensure that the network cable connector is firmly connected to the optional connector on the computer and the network wall jack.

**CHECK THE NETWORK LIGHTS ON THE NETWORK CONNECTOR** — Green indicates that the network connection is active. If the status light is not green, try replacing the network cable. Amber indicates that the optional network adapter driver is loaded and the adapter is detecting activity.

**RESTART THE COMPUTER** — Try to log on to the network again.

**CONTACT YOUR NETWORK ADMINISTRATOR** — Verify that your network settings are correct and that the network is functioning.

## Connecting to Wireless Local Area Networks

**NOTE:** These networking instructions do not apply to Bluetooth or cellular products.

Before you can connect to a wireless Local Area Network (LAN), you must have specific information about your network. Be sure to get the name of your wireless network along with any special security settings from your network administrator. These settings are unique to your network and cannot be provided by Dell.

### Determining your Network Type

**NOTE:** Most wireless networks are the infrastructure type. Consult your network administrator if you are unsure of the type of network you are connecting to.

Wireless networks fall into two categories — infrastructure networks and ad-hoc networks. An infrastructure network uses routers or access points to connect several computers together. An ad-hoc network does not use routers or access points and consists of computers that broadcast to one another.

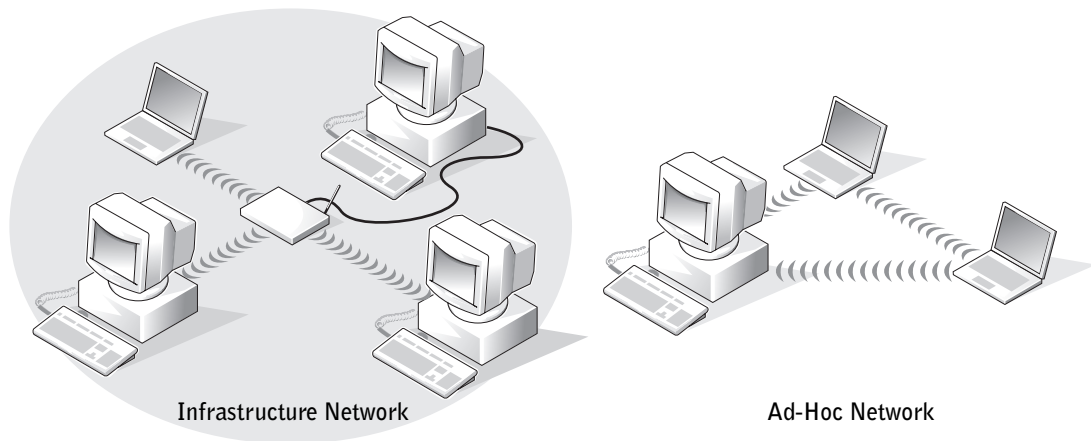

## Connecting to a Network in Windows XP

Your wireless network card requires proper software and drivers in order to connect to a network. This software is pre-installed from the factory. If the software is removed or corrupted, follow the instructions listed in the *User's Guide* for your wireless card. The *User's Guide* is located on your *Drivers, Utilities, and Applications* CD (that came with your computer) in the "User's Guides-Network User's Guides" category. The *User's Guide* is also available on the Dell Support website at [support.dell.com](http://support.dell.com).

- 1 Click **Start, Control Panel**, and then click **Switch to Classic View**.
- 2 Double-click **Network Connections**.
- 3 Click **Wireless Network Connection**.

The **Wireless Network Connection** icon is highlighted.

- 4 Under **Network Tasks** in the left-hand pane, click **Change settings of this connection**.

The **Wireless Network Connection Properties** window appears.

- 5 Select the **Wireless Networks** tab.

**NOTE:** The names of wireless networks that your computer can see are listed in the **Available Networks** area.



**6** Click **Add**.

The **Wireless network properties** window appears.

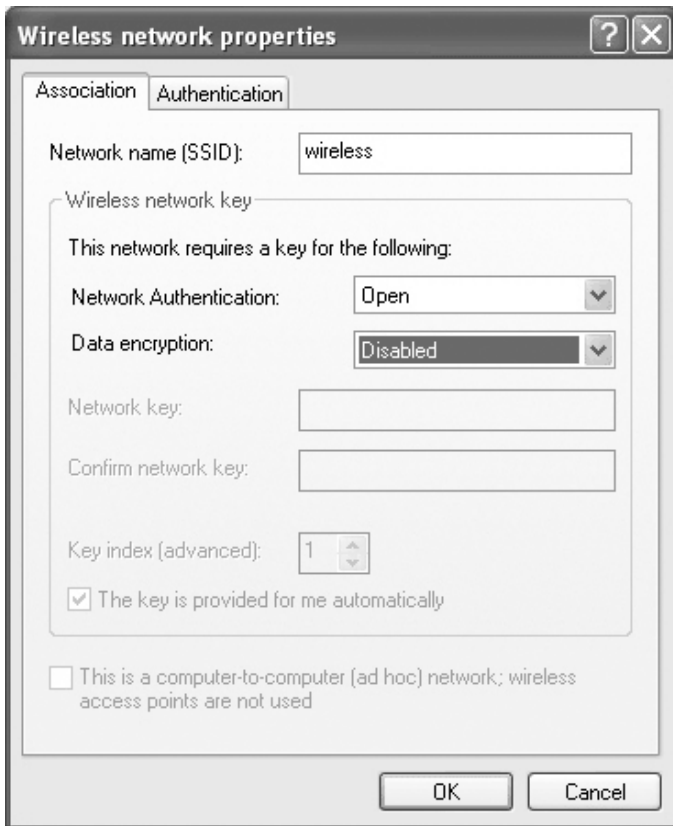

- 7 Enter the name of your network in the **Network name (SSID)** field.
- 8 If you are connecting to an ad-hoc network, which does not use any routers or access points, click the check box labeled **This is a computer-to-computer (ad hoc) network; wireless access points are not used**.
- 9 Click **OK**.

Your new network name appears in the **Preferred networks** area.



## Finalizing your Network Connection (Security Settings)

To finalize your connection, you must change your wireless security settings to match the wireless network you are trying to connect to. Choose one of the following connection options based on the security settings for your network:

- Connecting to a Network with no Security-Related Requirements (Common for home and small office networks)
- Connecting to a Network with Wi-Fi Protected Access (WPA) Security Requirements
- Connecting to a Network with Wired Equivalent Protocol (WEP) Security Requirements

## Connecting to a Network with no Security-Related Requirements

- 1 In the **Preferred networks** area, click the name of your wireless network.
- 2 Click **Properties**.
- 3 From the **Network Authentication** drop-down menu, select **Open**.

Earlier versions of the Dell wireless software may not contain the drop-down menus. If you are using an earlier version, de-select the **Data encryption (WEP enabled)** check box and go to step 5.

- 4 From the **Data encryption** drop-down menu, select **Disabled**.
- 5 Click **OK**.

Your network setup is complete.

## Connecting to a Network with Wi-Fi Protected Access (WPA) Security Requirements

The following instructions are basic steps for connecting to a WPA network. If your network requires a user name, password, or domain-settings, consult the setup instructions in the *User's Guide* for your wireless network card.

- 1 In the **Preferred networks** section, click the name of your wireless network.
- 2 Click **Properties**.
- 3 From the **Network Authentication** drop-down menu, select your network authentication type (as provided by the network administrator).

If you do not see the drop-down menus, you must update your wireless software before continuing. Download and install the latest version of your wireless driver software from the Dell Support website at [support.dell.com](http://support.dell.com).

 **NOTE:** Network security settings are only provided by your network administrator and are unique to your network. Dell cannot provide this information.

 **NOTE:** Your computer may take up to a minute to attach to the network.

 **NOTE:** WPA protocols require that you know the Network Authentication and Data Encryption settings for your wireless network. In addition, your WPA-protected network may require special settings such as a network key, user name, password, and domain name. Be sure to get all necessary WPA settings from your network administrator before continuing.

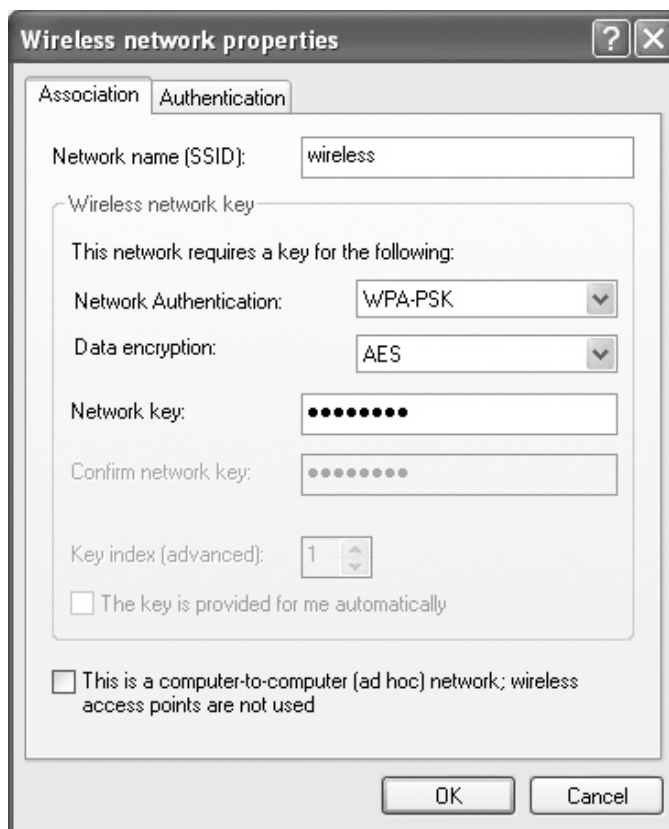

- 4 From the **Data encryption** drop-down menu, select your data encryption type (as provided by the network administrator).
- 5 If your wireless network requires a key, enter it in the **Network key** field.
- 6 Click **OK**.  
Your network setup is complete.

 **NOTE:** Your computer may take up to a minute to attach to the network.

### Connecting to a Network with Wired Equivalent Protocol (WEP) Security Requirements

- 1 In the **Preferred networks** section, click the name of your wireless network.

- 2 Click **Properties**.
- 3 From the **Network Authentication** drop-down menu, select **Open**.

Earlier versions of Dell wireless software may not contain the drop-down menus. If you are using an earlier version, select the check box labeled **Data encryption (WEP enabled)** and go to step 5.

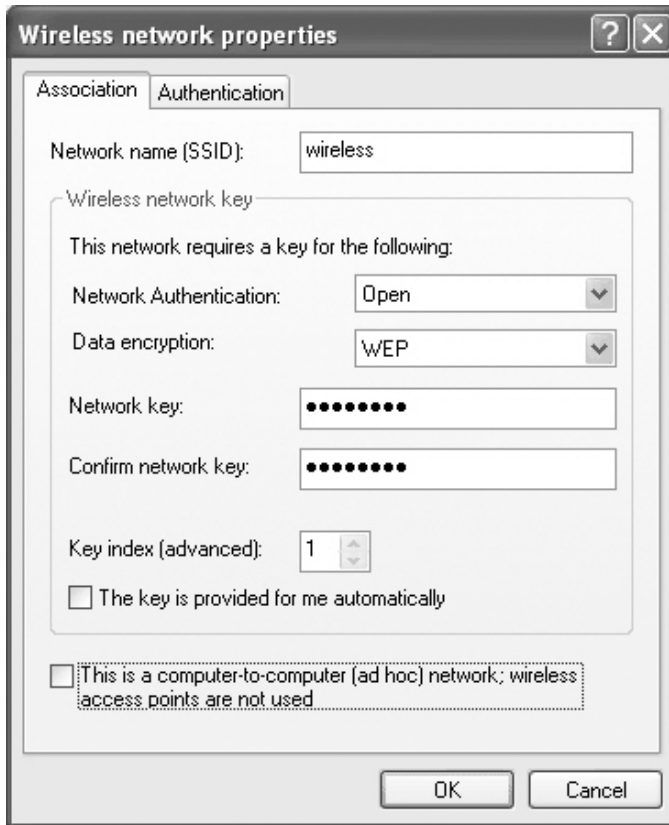

- 4 From the **Data encryption** drop-down menu, select **WEP**.
- 5 If the wireless network does not require a network key (for example, password), go to step 8.
- 6 De-select the check box labeled **The key is provided for me automatically**.



**NOTE:** Your computer may take up to a minute to attach to the network.

- 7** Enter the WEP network key, provided by your network administrator, in the **Network key** field.
  - 8** Enter this key again in the **Confirm network key** field.
  - 9** Click **OK**.
- Your network setup is complete.

## SECTION 7

# Solving Problems

---

Finding Solutions

Accessing Help

Error Messages

Video and Display Problems

Scanner Problems

Drive Problems

PC Card Problems

General Program Problems

If Your Computer Gets Wet

If You Drop or Damage Your Computer

Resolving Other Technical Problems

Drivers

Using System Restore

Resolving Software and Hardware Incompatibilities

Reinstalling Microsoft® Windows® XP

 **NOTE:** If you have a problem with an external device, see the device documentation or contact the manufacturer.

## Finding Solutions

Sometimes it's difficult to figure out where to go for answers. Use this chart to quickly find the answers to your questions.

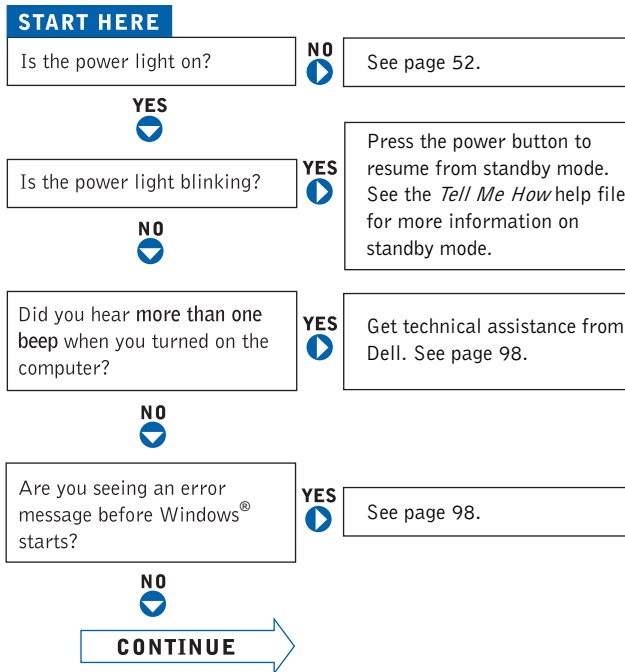

Are you having a problem with...

**NO**  
▶



video or the display?

**YES**  
▶

See page 99.

sound or the speakers?

**YES**  
▶

See page 73.

the printer?

**YES**  
▶

See page 40.

the modem?

**YES**  
▶

See page 35.

the scanner?

**YES**  
▶

See page 101.

the touch pad?

**YES**  
▶

See page 68.

the external keyboard?

**YES**  
▶

See page 68.

unexpected characters?

**YES**  
▶

See page 69.

the hard drive or a disk drive?

**YES**  
▶

See page 102

the network adapter?

**YES**  
▶

See page 85.

Windows error messages?

**YES**  
▶

See page 98.

a program?

**YES**  
▶

See page 104.

the Internet?

**YES**  
▶

See page 34.

your e-mail?

**YES**  
▶

See page 36.

Are you having some other type of problem?

**YES**  
▶

See page 106.

## Accessing Help

### **TO ACCESS THE *TELL ME HOW* HELP FILE —**

- 1 Click the **Start** button and click **Help and Support**.
- 2 Click **User and system guides** and click **User's guides**.
- 3 Click **Tell Me How**.

### **TO ACCESS HELP —**

- 1 Click the **Start** button and click **Help and Support**.
- 2 Type a word or phrase that describes your problem and click the arrow icon.
- 3 Click the topic that describes your problem.
- 4 Follow the instructions shown on the screen.

## Error Messages

If the message is not listed, see the documentation for the operating system or the program that was running at the time the message appeared.

### **THE FILE BEING COPIED IS TOO LARGE FOR THE DESTINATION**

**DRIVE** — The file that you are trying to copy is too large to fit on the disk, or the disk is too full. Try copying the file to a different disk or use a larger capacity disk.

### **A FILENAME CANNOT CONTAIN ANY OF THE FOLLOWING**

**CHARACTERS: \ / : \* ? " < > | —** Do not use these characters in filenames.

**INSERT BOOTABLE MEDIA** — The operating system is trying to boot to a nonbootable floppy disk or CD. Insert a bootable floppy disk or CD.

**NON-SYSTEM DISK OR DISK ERROR** — A floppy disk is in the floppy drive. Remove the floppy disk and restart the computer.

**NOT ENOUGH MEMORY OR RESOURCES. EXIT SOME PROGRAMS AND TRY AGAIN** — You have too many programs open. Close all windows and open the program that you want to use.

**OPERATING SYSTEM NOT FOUND** — Contact Dell (see "Accessing Help" on page 98).



**A REQUIRED .DLL FILE WAS NOT FOUND** — The program that you are trying to open is missing an essential file. Remove and then reinstall the program.



- 1 Click the **Start** button.
- 2 *Click Control Panel.*
- 3 Click **Add or Remove Programs**.
- 4 Select the program you want to remove.
- 5 Click **Remove** or **Change/Remove** and follow the prompts on the screen.
- 6 See the program documentation for installation instructions.

**X:\ IS NOT ACCESSIBLE. THE DEVICE IS NOT READY** — Insert a disk into the drive and try again.

## Video and Display Problems

### If the display is blank

**CHECK THE  LIGHT** — When the  light is blinking, the computer has power.

- If the  light is blinking, the computer is in standby mode—press the power button to exit standby mode.
- If the  light is off, press the power button.
- If the  light is on, your power management settings may have caused the display to turn off. Try pressing any key or move the cursor to exit standby mode.

**CHECK THE BATTERY** — If you are using a battery to power your computer, the battery charge may be depleted. Connect the computer to an electrical outlet using the AC adapter, and turn on the computer.



 **NOTE:** If you are using a program that requires a higher resolution than your computer supports, it is recommended that you attach an external monitor to your computer.

**TEST THE ELECTRICAL OUTLET** — Ensure that the electrical outlet is working by testing it with another device, such as a lamp.

**CHECK THE AC ADAPTER** — Check the AC adapter cable connections. If the AC adapter has a light, ensure that it is on.

**CONNECT THE COMPUTER DIRECTLY TO AN ELECTRICAL OUTLET** — Bypass power protection devices, power strips, and the extension cable to verify that the computer turns on. To access the help file, see "Accessing Help" on page 98.

**ADJUST THE POWER PROPERTIES** — Search for the keyword *standby* in the Help and Support Center. For instructions on accessing help files, see "Accessing Help" on page 98.

**SWITCH THE VIDEO IMAGE** — If your computer is attached to an external monitor, press   to switch the video image to the display.

## If the display is difficult to read

**ADJUST THE BRIGHTNESS** — See the *Tell Me How* help file for instructions on adjusting the brightness. To access the help file, see "Accessing Help" on page 98.

**MOVE THE SUBWOOFER AWAY FROM THE COMPUTER OR MONITOR** — If your external speaker system includes a subwoofer, ensure that the subwoofer is at least 60 cm (2 ft) away from the computer or external monitor.

**ELIMINATE POSSIBLE INTERFERENCE** — Turn off nearby fans, fluorescent lights, halogen lamps, or other appliances.

**ROTATE THE COMPUTER TO FACE A DIFFERENT DIRECTION** — Eliminate sunlight glare, which can cause poor picture quality.

#### **ADJUST THE WINDOWS DISPLAY SETTINGS —**

- 1 Click the **Start** button and click **Control Panel**.
- 2 Click **Appearance and Themes**.
- 3 Click the area you want to change or click the **Display** icon.
- 4 Try different settings for **Color quality** and **Screen resolution**.

**SEE "ERROR MESSAGES"** — If an error message appears, see "Error Messages" on page 98.

### **If only part of the display is readable**

#### **CONNECT AN EXTERNAL MONITOR —**

- 1 Turn off your computer and connect an external monitor to the computer.
- 2 Turn on the computer and the monitor, and adjust the monitor brightness and contrast controls.

If the external monitor works, the computer display or video controller may be defective. Contact Dell (see "Contacting Dell" on page 139).

## **Scanner Problems**

**CHECK THE POWER CABLE CONNECTION —** Ensure that the scanner power cable is firmly connected to a working electrical power source and that the scanner is turned on.

**CHECK THE SCANNER CABLE CONNECTION —** Ensure that the scanner cable is firmly connected to the computer and to the scanner.

**UNLOCK THE SCANNER —** Ensure that your scanner is unlocked if it has a locking tab or button.

**REINSTALL THE SCANNER DRIVER —** See the scanner documentation for instructions.

 **NOTE:** If you can connect to your Internet service provider (ISP), your modem is functioning properly. If you are sure that your modem is working properly and you still experience problems, contact your ISP.

**NOTE:** For information on saving files to a floppy disk, see the *Tell Me How* help file. To access the help file, see "Accessing Help" on page 98.

## Drive Problems

### If you cannot save a file to a floppy drive

**ENSURE THAT WINDOWS® RECOGNIZES THE DRIVE** — Click the Start button and click My Computer. If the drive is not listed, perform a full scan with your antivirus software to check for and remove viruses. Viruses can sometimes prevent Windows from recognizing the drive. Insert a bootable disk and restart the computer. Verify that the  light is blinking, indicating normal operation.

**ENSURE THAT THE DISK IS NOT WRITE-PROTECTED** — You cannot save data to a write-protected disk. See the following figure.

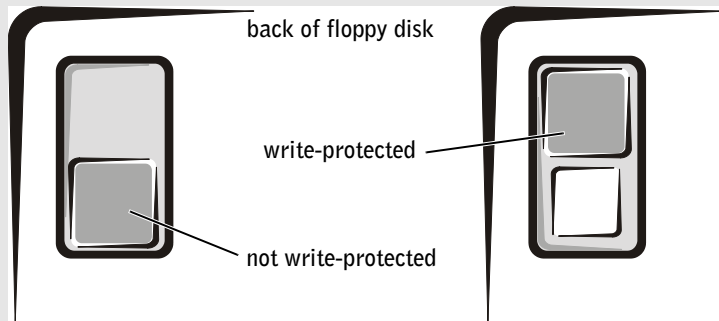

**TRY ANOTHER FLOPPY DISK** — Insert another disk to eliminate the possibility that the original disk is defective.

### **REINSTALL THE DRIVE —**

- 1** Save and close any open files, exit any open programs, and shut down the computer.
- 2** Remove the drive from the module bay. See "Using the Module Bay" in the *Tell Me How* help file for instructions. To access the help file, see "Accessing Help" on page 98.
- 3** Reinstall the drive.
- 4** Turn on the computer.

**CLEAN THE DRIVE —** See "Cleaning Your Computer" in the *Tell Me How* help file for instructions. To access the help file, see "Accessing Help" on page 98.

## **If you have problems with a hard drive**

**ALLOW THE COMPUTER TO COOL BEFORE TURNING IT ON —** A hot hard drive may prevent the operating system from starting. Try allowing the computer to return to room temperature before turning it on.

### **CHECK THE DRIVE FOR ERRORS —**

- 1** Click the **Start** button and click **My Computer**.
- 2** Right-click the drive letter (local disk) that you want to scan for errors, and then click **Properties**.
- 3** Click the **Tools** tab.
- 4** Under **Error-checking**, click **Check Now**.
- 5** Click **Start**.

## **PC Card Problems**

**CHECK THE PC CARD —** Ensure that the PC Card is properly inserted into the connector.

**ENSURE THAT THE CARD IS RECOGNIZED BY WINDOWS® —** Double-click the **Unplug or Eject Hardware** icon in the Windows taskbar. Ensure that the card is listed.

 **NOTE:** Software usually includes installation instructions in its documentation or on a floppy disk or CD.

**IF YOU HAVE PROBLEMS WITH A DELL-PROVIDED PC CARD —**  
Contact Dell (see "Accessing Help" on page 98).

**IF YOU HAVE PROBLEMS WITH A PC CARD NOT PROVIDED BY  
DELL —** Contact the PC Card manufacturer.



## General Program Problems

### A program crashes

**SEE THE SOFTWARE DOCUMENTATION —** Many software manufacturers maintain websites with information that may help you solve the problem. Ensure that you properly installed and configured the program. Reinstall the program if necessary.

### A program stops responding

**END THE PROGRAM —**

- 1 Simultaneously press   .
- 2 Click the **Applications** tab, and then select the program that is no longer responding.
- 3 Click **End Task**.

### Error messages appear

**REVIEW "ERROR MESSAGES" —** Look up the message and take the appropriate action. See the software documentation.

# If Your Computer Gets Wet

 **CAUTION:** Perform this procedure only after you are certain that it is safe to do so. If the computer is connected to an electrical outlet, it is recommended that you turn off AC power at the circuit breaker before attempting to remove the power cables from the electrical outlet. Use the utmost caution when removing wet cables from a live power source.

- 1 Shut down the computer (see "Turning Off Your Computer" on page 43), disconnect the AC adapter from the computer, and then disconnect the AC adapter from the electrical outlet.
- 2 Turn off any attached external devices, and disconnect them from their power sources and then from the computer.
- 3 Ground yourself by touching one of the metal connectors on the back of the computer.
- 4 Remove the module bay device and any installed PC Cards, and put them in a safe place to dry.
- 5 Remove the battery.
- 6 Wipe off the battery and put it in a safe place to dry.
- 7 Remove the hard drive (see "Replacing the Hard Drive" on page 123).
- 8 Remove the memory module(s) (see "Adding Memory" on page 118).
- 9 Open the display and place the computer right-side up across two books or similar props to let air circulate all around it. Let the computer dry for at least 24 hours in a dry area at room temperature.

 **NOTICE:** Do not use artificial means, such as a hair dryer or a fan, to speed the drying process.

 **CAUTION:** To help prevent electrical shock, verify that the computer is thoroughly dry before continuing with the rest of this procedure.

- 10 Ground yourself by touching one of the metal connectors on the back of the computer.
- 11 Replace the memory module(s), the memory module cover, and the screw(s).
- 12 Replace the hard drive.
- 13 Replace the module bay device and any PC Cards you removed.

 **NOTE:** See "Limited Warranties and Return Policy" on page 159 for information on your warranty coverage.

- 14 Replace the battery.
- 15 Turn on the computer and verify that it is working properly.

If the computer does not start, or if you cannot identify the damaged components, contact Dell (see "Contacting Dell" on page 139).

## If You Drop or Damage Your Computer

- 1 Save and close any open files, exit any open programs, and shut down the computer (see "Turning Off Your Computer" on page 43).
- 2 Disconnect the AC adapter from the computer and from the electrical outlet.
- 3 Turn off any attached external devices, and disconnect them from their power sources and then from the computer.
- 4 Remove and reinstall the battery.
- 5 Turn on the computer.

If the computer does not start, or if you cannot identify the damaged components, contact Dell (see "Contacting Dell" on page 139).

 **NOTE:** See "Limited Warranties and Return Policy" on page 159 for information on your warranty coverage.

## Resolving Other Technical Problems

**GO TO THE DELL SUPPORT WEBSITE** — Go to [support.dell.com](http://support.dell.com) for help with general usage, installation, and troubleshooting questions. See "Dell Technical Support Policy (U.S. Only)" on page 138 for a description of the hardware and software support provided by Dell.

**E-MAIL DELL** — Go to [support.dell.com](http://support.dell.com) and then click **E-Mail Dell** in the **Communicate** list. Send an e-mail message to Dell about your problem; you can expect to receive an e-mail message from Dell within hours. See "Dell Technical Support Policy (U.S. Only)" on page 138 for a description of the hardware and software support provided by Dell.

**CONTACT DELL** — If you cannot solve your problem using the Dell™ Support website or e-mail service, call Dell for technical assistance (see "Contacting Dell" on page 139). See "Dell Technical Support Policy (U.S. Only)" on page 138 for a description of the hardware and software support provided by Dell.

# Drivers

## What Is a Driver?

A driver is a program that controls a device such as a printer, mouse, or keyboard. All devices require a driver program.

A driver acts like a translator between the device and the programs that use the device. Each device has its own set of specialized commands that only its driver recognizes.

Dell ships your computer to you with required drivers already installed—no further installation or configuration is needed.

 **NOTICE:** The *Drivers and Utilities* CD may contain drivers for operating systems that are not on your computer. Ensure that you are installing software appropriate for your operating system.

Many drivers, such as the keyboard driver, come with your Microsoft® Windows® operating system. You may need to install drivers if you:

- Upgrade your operating system.
- Reinstall your operating system.
- Connect or install a new device.

## Identifying Drivers

If you experience a problem with any device, identify whether the driver is the source of your problem and, if necessary, update the driver.

- 1 Click the **Start** button and click **Control Panel**.
- 2 Under **Pick a Category**, click **Performance and Maintenance**.
- 3 Click **System**.
- 4 In the **System Properties** window, click the **Hardware** tab.
- 5 Click **Device Manager**.
- 6 Scroll down the list to see if any device has an exclamation point (a yellow circle with a [!]) on the device icon.

If an exclamation point is next to the device name, you may need to reinstall the driver or install a new driver.

## Reinstalling Drivers and Utilities

 **NOTICE:** The Dell Support website at [support.dell.com](http://support.dell.com) and your *Drivers and Utilities* CD provide approved drivers for Dell™ computers. If you install drivers obtained from other sources, your computer might not work correctly.

### Using Windows XP Device Driver Rollback

If a problem occurs on your computer after you install or update a driver, use Windows XP Device Driver Rollback to replace the driver with the previously installed version.

- 1 Click the **Start** button and click **Control Panel**.
- 2 Under **Pick a Category**, click **Performance and Maintenance**.
- 3 Click **System**.
- 4 In the **System Properties** window, click the **Hardware** tab.
- 5 Click **Device Manager**.
- 6 Right-click the device for which the new driver was installed and click **Properties**.
- 7 Click the **Drivers** tab.
- 8 Click **Roll Back Driver**.

If Device Driver Rollback does not resolve the problem, then use System Restore (see "Using System Restore" on page 110) to return your computer to the operating state that existed before you installed the new driver.

### Using the Drivers and Utilities CD

If using Device Driver Rollback or System Restore (see "Using System Restore" on page 110) does not resolve the problem, then reinstall the driver from the *Drivers and Utilities* CD:

- 1 Save and close any open files, and exit any open programs.
- 2 Insert the *Drivers and Utilities* CD.

In most cases, the CD starts running automatically. If it does not, start Windows Explorer, click your CD drive directory to display the CD contents, and then double-click the **autocd.exe** file. The first time that you run the CD, it might prompt you to install setup files. Click **OK**, and follow the instructions on the screen to continue.

**3** From the **Language** drop-down menu in the toolbar, select your preferred language for the driver or utility (if available). A welcome screen appears.

**4** Click **Next**.

The CD automatically scans your hardware to detect drivers and utilities used by your computer.

**5** After the CD completes the hardware scan, you can also detect other drivers and utilities. Under **Search Criteria**, select the appropriate categories from the **System Model**, **Operating System**, and **Topic** drop-down menus.

A link or links appear(s) for the specific drivers and utilities used by your computer.

**6** Click the link of a specific driver or utility to display information about the driver or utility that you want to install.

**7** Click the **Install** button (if present) to begin installing the driver or utility. At the welcome screen, follow the screen prompts to complete the installation.

If no **Install** button is present, automatic installation is not an option. For installation instructions, either see the appropriate instructions in the following subsections, or click **Extract**, follow the extracting instructions, and read the readme file.

If instructed to navigate to the driver files, click the CD directory on the driver information window to display the files associated with that driver.

## Manually Reinstalling Drivers for Windows XP

- 1** After extracting the driver files to your hard drive as described in the previous section, click the **Start** button, point to **Settings**, and click **Control Panel**.
- 2** Click the **Start** button and right-click **My Computer**.
- 3** Click **Properties**.
- 4** Click the **Hardware** tab and click **Device Manager**.
- 5** Double-click the type of device for which you are installing the driver (for example, **Modems** or **Infrared devices**).



**NOTE:** If you are reinstalling an infrared sensor driver, you must first enable the infrared sensor in the system setup program (see "System Setup Screens" on page 135) before continuing with the driver installation.

- 6 Double-click the name of the device for which you are installing the driver.
- 7 Click the **Driver** tab and click **Update Driver**.
- 8 Click **Install from a list or specific location (Advanced)** and click **Next**.
- 9 Click **Browse** and browse to the location to which you previously extracted the driver files.
- 10 When the name of the appropriate driver appears, click **Next**.
- 11 Click **Finish** and restart your computer.

## Using System Restore

The Microsoft® Windows® XP operating system provides System Restore to allow you to return your computer to an earlier operating state (without affecting data files) if changes to the hardware, software, or other system settings have left the computer in an undesirable operating state. See the Help and Support Center for information on using System Restore. To access help, see page 98.

 **NOTICE:** Make regular backups of your data files. System Restore does not monitor your data files or recover them.

### Creating a Restore Point

- 1 Click the **Start** button and click **Help and Support**.
- 2 Click **System Restore**.
- 3 Follow the instructions on the screen.

### Restoring the Computer to an Earlier Operating State

 **NOTICE:** Before you restore the computer to an earlier operating state, save and close all open files and close all open programs. Do not alter, open, or delete any files or programs until the system restoration is complete.

- 1 Click the **Start** button, point to **All Programs**→**Accessories**→**System Tools**, and then click **System Restore**.
- 2 Ensure that **Restore my computer to an earlier time** is selected and click **Next**.

- 3 Click a calendar date to which you want to restore your computer.

The **Select a Restore Point** screen provides a calendar that allows you to see and select restore points. All calendar dates with available restore points appear in bold.

- 4 Select a restore point and click **Next**.

If a calendar date has only one restore point, then that restore point is automatically selected. If two or more restore points are available, click the restore point that you prefer.

- 5 Click **Next**.

The **Restoration Complete** screen appears after System Restore finishes collecting data and then the computer restarts.

- 6 After the computer restarts, click **OK**.

To change the restore point, you can either repeat the steps using a different restore point, or you can undo the restoration.

## Undoing the Last System Restore



**NOTICE:** Before you undo the last system restore, save and close all open files and close all open programs. Do not alter, open, or delete any files or programs until the system restoration is complete.

- 1 Click the **Start** button, point to **All Programs**→**Accessories**→**System Tools**, and then click **System Restore**.
- 2 Click **Undo my last restoration** and click **Next**.
- 3 Click **Next**.

The **System Restore** screen appears and the computer restarts.

- 4 After the computer restarts, click **OK**.

## Enabling System Restore

If you reinstall Windows XP with less than 200 MB of free hard-disk space available, System Restore is automatically disabled. To see if System Restore is enabled:

- 1 Click the **Start** button and click **Control Panel**.
- 2 Click **Performance and Maintenance**.
- 3 Click **System**.

- 4 Click the **System Restore** tab.
- 5 Ensure that **Turn off System Restore** is unchecked.

## Resolving Software and Hardware Incompatibilities

Windows XP IRQ conflicts occur if a device either is not detected during the operating system setup or is detected but incorrectly configured.

To check for conflicts on a computer running Windows XP:

- 1 Click the **Start** button and click **Control Panel**.
- 2 Click **Performance and Maintenance** and click **System**.
- 3 Click the **Hardware** tab and click **Device Manager**.
- 4 In the **Device Manager** list, check for conflicts with the other devices.  
Conflicts are indicated by a yellow exclamation point (!) beside the conflicting device or a red x if the device has been disabled.
- 5 Double-click any conflict to display the **Properties** window.  
If an IRQ conflict exists, the **Device** status area in the **Properties** window reports the cards or devices that share the device's IRQ.
- 6 Resolve conflicts by reconfiguring the devices or removing the devices from the **Device Manager**.

To use the Windows XP Hardware Troubleshooter:

- 1 Click the **Start** button and click **Help and Support**.
- 2 Type `hardware troubleshooter` in the **Search** field and click the arrow to start the search.
- 3 Click **Hardware Troubleshooter** in the **Search Results** list.
- 4 In the **Hardware Troubleshooter** list, click **I need to resolve a hardware conflict on my computer**, and click **Next**.

# Reinstalling Microsoft® Windows® XP

## Before You Reinstall

If you are considering reinstalling the Windows XP operating system to correct a problem with a newly installed driver, first try using Windows XP Device Driver Rollback (see "Using Windows XP Device Driver Rollback" on page 108). If Device Driver Rollback does not resolve the problem, then use System Restore (see "Using System Restore" on page 110) to return your operating system to the operating state it was in before you installed the new device driver.

## Reinstalling Windows XP

To reinstall Windows XP, perform all the steps in the following sections in the order in which they are listed.

The reinstallation process can take 1 to 2 hours to complete. After you reinstall the operating system, you must also reinstall the device drivers, virus protection program, and other software.

- ➔ **NOTICE:** The *Operating System* CD provides options for reinstalling Windows XP. The options can overwrite files and possibly affect programs installed on your hard drive. Therefore, do not reinstall Windows XP unless instructed to do so by a Dell technical support representative.
- ➔ **NOTICE:** To prevent conflicts with Windows XP, disable any virus protection software installed on your computer before you reinstall Windows XP. See the documentation that came with the software for instructions.





## Booting From the Operating System CD

- 1 Save and close any open files and exit any open programs.
- 2 Insert the *Operating System* CD. If any program starts automatically, exit the program before proceeding.
- 3 Shut down the computer through the **Start** menu (see "Turning Off Your Computer" on page 43) and restart the computer.
- 4 Press  immediately after the DELL™ logo appears.

If the operating system logo appears, wait until you see the Windows desktop, and then shut down the computer and try again.

- 5 Press the arrow keys to select **CD-ROM**, and then press .
- 6 When the **Press any key to boot from CD** message appears, press any key.

### Windows XP Setup

- 1 When the **Windows XP Setup** screen appears, press  to select **To set up Windows now**.
- 2 Read the information on the **Microsoft Windows Licensing Agreement** screen, and press  to accept the license agreement.
- 3 If your computer already has Windows XP installed and you want to recover your current Windows XP data, type **r** to select the repair option, and then remove the CD from the drive.
- 4 If you want to install a new copy of Windows XP, press  to select that option.
- 5 Press  to select the highlighted partition (recommended), and then follow the instructions on the screen.

The **Windows XP Setup** screen appears, and the operating system begins to copy files and install the devices. The computer automatically restarts multiple times.

- ➔ **NOTICE:** Do not press any key when the following message appears: **Press any key to boot from the CD**.
- 6 When the **Regional and Language Options** screen appears, select the settings for your location, and then click **Next**.
- 7 Enter your name and organization (optional) in the **Personalize Your Software** screen and click **Next**.
- 8 *If you are reinstalling Windows XP Home Edition*, at the **What's your computer's name** window, enter a name for your computer (or accept the name provided) and click **Next**.  
*If you are reinstalling Windows XP Professional*, at the **Computer Name and Administrator Password** window, enter a name for your computer (or accept the one provided) and a password, and then click **Next**.
- 9 If the **Modem Dialing Information** screen appears, enter the requested information and click **Next**.

 **NOTE:** The time required to complete the setup depends on the size of the hard drive and the speed of your computer.

- 10 Enter the date, time, and time zone in the **Date and Time Settings** window and click **Next**.
- 11 If the **Networking Settings** screen appears, click **Typical** and click **Next**.
- 12 If you are reinstalling Windows XP Professional and you are prompted to provide further information regarding your network configuration, enter your selections. If you are unsure of your settings, accept the default selections.

Windows XP installs the operating system components and configures the computer. The computer automatically restarts.

 **NOTICE:** Do not press any key when the following message appears: Press any key to boot from the CD.

- 13 When the **Welcome to Microsoft** screen appears, click **Next**.
- 14 When the **How will this computer connect to the Internet?** message appears, click **Skip**.
- 15 When the **Ready to register with Microsoft?** screen appears, select **No, not at this time** and click **Next**.
- 16 When the **Who will use this computer?** screen appears, you can enter up to five users. Click **Next**.
- 17 Click **Finish** to complete the setup, and remove the CD from the drive.

## Reinstalling Drivers and Software

- 1 Reinstall the appropriate drivers (see "Drivers" on page 107).
- 2 Reinstall your virus protection software. See the documentation that came with the software for instructions.
- 3 Reinstall your other software programs. See the documentation that came with the software for instructions.



SECTION 8

## **Adding and Replacing Parts**

---

Adding Memory

Adding a Mini PCI Card

Replacing the Hard Drive

## Adding Memory

You can increase your computer memory by installing memory modules on the system board. See "Specifications" on page 128 for information on the memory supported by your computer. Be sure to add only memory modules that are intended for your computer.

 **NOTE:** Memory modules purchased from Dell are covered under your computer warranty.

 **CAUTION:** Before working inside your Dell™ computer, read the safety instructions on page 11.

- 1** Save and close any open files, exit any open programs, and shut down the computer (see "Turning Off Your Computer" on page 43).
  - 2** If the computer is connected to a docking device (docked), undock it. See the documentation that came with your docking device for instructions.
  - 3** Remove all installed batteries, and disconnect the AC adapter cable and any external devices from the computer. Wait 5 seconds before proceeding.
  - 4** Ground yourself by touching a metal connector on the back of the computer, and continue to do so periodically during this procedure.
-  **NOTICE:** While you work, periodically touch unpainted metal on the computer to dissipate static electricity that might harm internal components.
- 5** Turn the computer over, remove the screw from the memory module cover, and lift the cover.

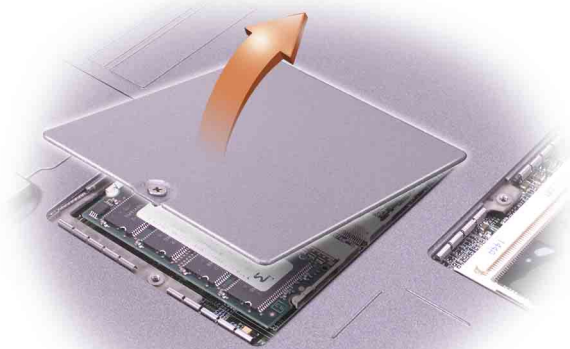

➔ **NOTICE:** To prevent damage to the memory module connector, do not use tools to spread the inner metal tabs that secure the memory module.

6 If you are replacing a memory module, remove the existing module.

➔ **NOTICE:** Handle memory modules by their edges, and do not touch the components on a module.

a Use your fingertips to carefully spread apart the securing clips on each end of the memory module connector until the module pops up.

b Remove the module from the connector.

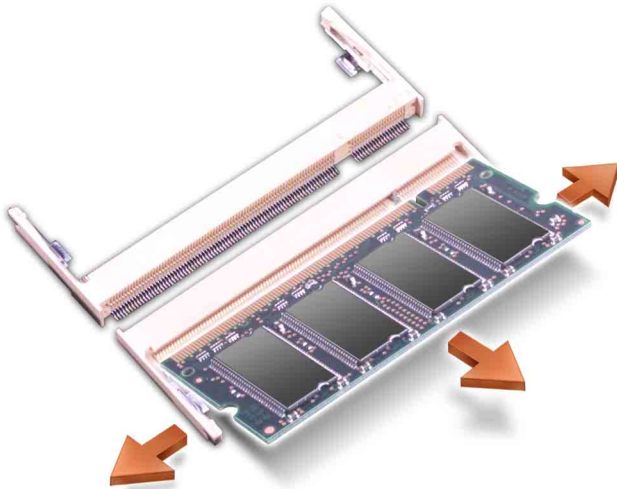

➔ **NOTICE:** If you need to install memory modules in two connectors, install a memory module in the connector labeled "SL0T 1" before you install a module in the other connector.

7 Ground yourself and install the new memory module:

a Align the notch in the module with the slot in the center of the connector.

b Slide the edge of the module firmly into the connector, and rotate the module down until you feel a click. If you do not feel the click, remove the module and reinstall it.

8 Replace the cover and screw.

 **NOTE:** If the memory module is not installed properly, the computer does not boot. No error message indicates this failure.

 **NOTICE:** If the memory module cover is difficult to close, remove the module and reinstall it. Forcing the cover to close may damage your computer.

9 Insert the battery into the battery bay, or connect the AC adapter to your computer and an electrical outlet.

10 Turn on the computer.

As the computer boots, it detects the additional memory and automatically updates the system configuration information.

## Adding a Mini PCI Card

If you ordered a Mini PCI card at the same time that you ordered your computer, Dell has already installed the card for you.

 **CAUTION: FCC rules strictly prohibit users from installing 5-GHz (802.11a, 802.11a/b, 802.11a/b/g) Wireless LAN Mini PCI cards. Under no circumstances should the user install such a device. Only trained Dell service personnel are authorized to install a 5-GHz Wireless LAN Mini PCI card.**

**If you are removing and/or installing a 2.4-GHz (802.11b, 802.11b/g) Mini PCI card, follow the instructions noted below. Only products approved for use in your portable computer may be installed. Approved Mini PCI cards may be purchased only from Dell.**

 **NOTE:** 2.4-G Hz Wireless LAN PC Cards may be removed and installed by the user.

 **NOTE:** Handle components and cards by their edges, and avoid touching pins and contacts.

 **CAUTION: Before working inside your computer, read the safety instructions at the front of this guide (see page 11).**

- 1 Ensure that the work surface is flat and clean to prevent scratching the computer cover.
- 2 Save and close any open files, exit any open programs, and shut down the computer (see "Turning Off Your Computer" on page 43).
- 3 If the computer is connected to a docking device (docked), undock it. See the documentation that came with your docking device for instructions.

- 4 Remove all installed batteries, and disconnect the AC adapter cable and any external devices from the computer. Wait 5 seconds before proceeding.
- 5 Ground yourself by touching a metal connector on the back of the computer, and continue to do so periodically during this procedure.
- 6 Turn the computer over, and remove the screw from the Mini PCI card cover.

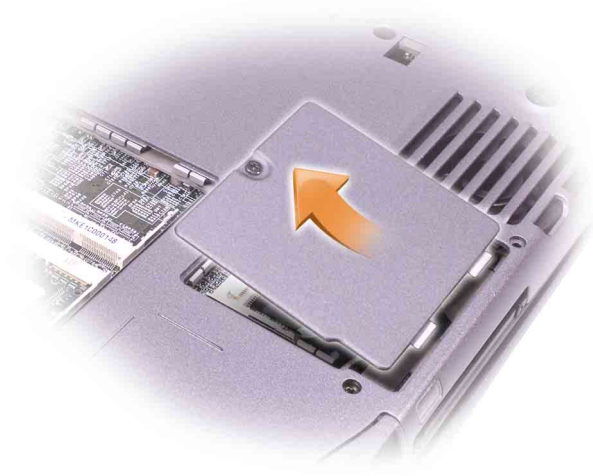

- 7 Place your finger under the cover at the indentation, and lift and slide the cover open.

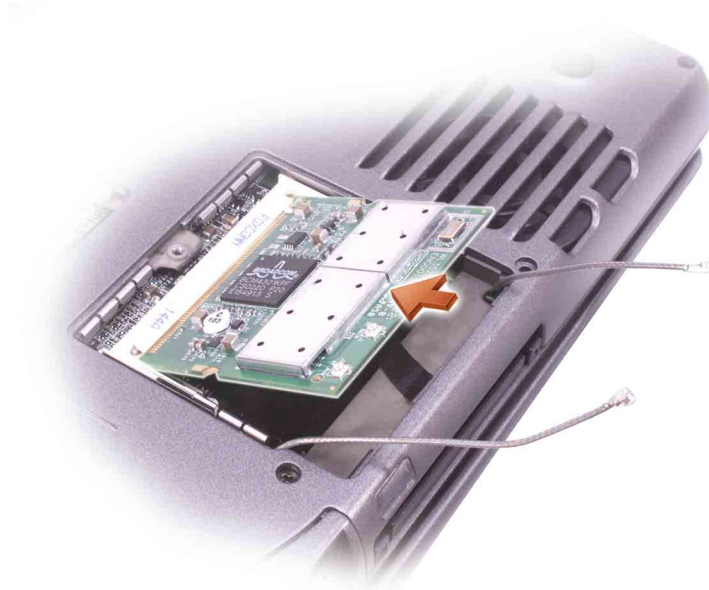

- 8** If a Mini PCI card is not already installed, go to step 9. If you are replacing a Mini PCI card, remove the existing card:
    - a** Disconnect the Mini PCI card from any attached cables.
    - b** Release the Mini PCI card by spreading the metal securing tabs until the card pops up slightly.
    - c** Lift the Mini PCI card out of its connector.
  - 9** Align the new Mini PCI card with the connector at a 45-degree angle, and press the Mini PCI card into the connector.
  - 10** Connect the antenna cables from the Mini PCI card to the antenna connectors on the computer.
- ➔ NOTICE:** The connectors are keyed for correct insertion; do not force the connections.

antenna connectors on card (2)

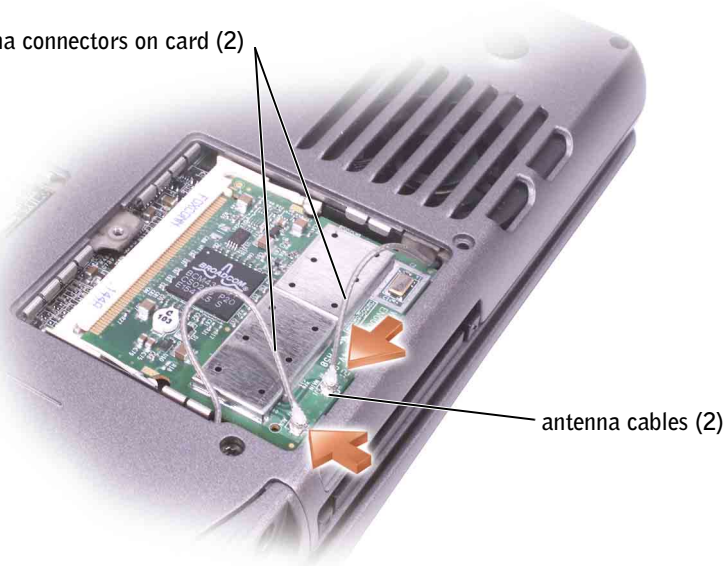

- 11 Lower the Mini PCI card toward the inner tabs to approximately a 20-degree angle.
- 12 Continue lowering the Mini PCI card until it snaps into the inner tabs of the connector.
- 13 Replace the cover.

## Replacing the Hard Drive

- ➡ **NOTICE:** To prevent data loss, shut down your computer (see "Turning Off Your Computer" on page 43) before removing the hard drive. Do not remove the hard drive while the computer is on, in standby mode, or in hibernate mode.
- ➡ **NOTICE:** Hard drives are extremely fragile; even a slight bump can damage the drive.
- ⚠ **CAUTION:** If you remove the hard drive from the computer when the drive is hot, *do not touch* the metal housing of the hard drive.
- ⚠ **CAUTION:** Before working inside your computer, read the safety instructions at the front of this guide (see page 11).

**NOTE:** Dell does not guarantee compatibility or provide support for hard drives from sources other than Dell.

**NOTE:** You need the *Operating System* CD to install the Microsoft® Windows® operating system. You also need the *Drivers and Utilities* CD for your computer to install the drivers and utilities on the new hard drive.

- 1 Ensure that the work surface is flat and clean to prevent scratching the computer cover.
- 2 Save and close any open files, exit any open programs, and shut down the computer (see "Turning Off Your Computer" on page 43).
- 3 If the computer is connected to a docking device (docked), undock it. See the documentation that came with your docking device for instructions.
- 4 Remove all installed batteries, and disconnect the AC adapter cable and any external devices from the computer. Wait 5 seconds before proceeding.
- 5 Ground yourself by touching a metal connector on the back of the computer, and continue to do so periodically during this procedure.
- 6 Turn the computer over. Use a small screwdriver to loosen the M2.5 x 5-mm screw.



- 7 Turn the computer over so that it is upright.



- ➡ **NOTICE:** When the hard drive is not in the computer, store it in protective antistatic packaging. See "Protecting Against Electrostatic Discharge" on page 17.
- 8 Pull the hard drive cover out of the computer.
- 9 Remove the new drive from its packaging.  
Save the original packaging for use when storing or shipping the hard drive.
- ➡ **NOTICE:** You cannot replace your hard drive unless you open your display first.
- 10 Ensure that the display is open approximately 2.54 cm (1 in).
- ➡ **NOTICE:** Use firm and even pressure to slide the drive into place. If you force the hard drive into place using excessive force, you may damage the hard drive connector.
- 11 Press the hard drive cover into the bay until it is fully seated in the bay.
- 12 Turn the computer over. Use a small screwdriver to tighten the screw.
- 13 Use the *Operating System* CD to install the operating system for your computer (see "Reinstalling Microsoft® Windows® XP" on page 113).
- 14 Use the *Drivers and Utilities* CD to install the drivers and utilities for your computer (see "Drivers" on page 107).



SECTION 9

## **Appendix**

Specifications  
Standard Settings  
Dell Technical Support Policy (U.S. Only)  
Contacting Dell  
Regulatory Notices  
Limited Warranties and Return Policy

# Specifications

---

## Microprocessor

---

Microprocessor type	Intel®
L1 cache	32 KB (internal)
L2 cache	1 MB
External bus frequency	400 MHz, source synchronous processor system bus

---

## System Information

---

Data bus width	64 bits
DRAM bus width	64 bits
Microprocessor address bus width	32 bits
Flash EPROM	1 MB
Graphics bus	64 bits (with 32 MB of video memory); 128 bits (with 64 MB of video memory)
PCI bus	32 bits

---

## PC Card

---

CardBus controller	OZ711EC1 CardBus controller
PC Card connector	supports one Type I or Type II card
Cards supported	3.3 V and 5 V
PC Card connector size	68 pins
Data width (maximum)	PCMCIA 16 bits; CardBus 32 bits

---

## Smart Card

---

Read/write capabilities	reads and writes to all ISO 7816 1/2/3/4 microprocessor cards (T=0, T=1)
Cards supported	3 V and 5 V
Program technology supported	Java cards

---

**Smart Card (continued)**

---

Interface speed	9600–115,200 BPS
EMV level	level 1 certified
WHQL certification	PC/SC
Compatibility	compatible within a PKI environment
Insert/eject cycles	certified for up to 100,000 cycles

---

**Memory**

---

Minimum requirement	266 MHz
Memory module connector	two user-accessible DDR SDRAM connectors
Memory module capacities	128 MB, 256 MB, 512 MB, and 1 GB
Memory type	3.3-V DDR SDRAM
Standard memory	128 MB
Maximum memory	2 GB

---

**Ports and Connectors**

---

Serial	9-pin connector; 16550C-compatible, 16-byte buffer connector
Parallel	25-hole connector; unidirectional, bidirectional, or ECP
Video	15-hole connector
Audio	microphone miniconnector, stereo headphones/speakers miniconnector
USB	two 4-pin USB 2.0-compliant connectors
Infrared sensor	sensor compatible with IrDA Standard 1.1 (Fast IR) and IrDA Standard 1.0 (Slow IR)
S-video TV-out	7-pin mini-DIN connector (optional S-video to composite video adapter cable)
Mini PCI	Type IIIA Mini PCI card slot

---

**Ports and Connectors (continued)**

---

Modem	RJ-11 port
Network adapter	RJ-45 port

---

**Communications**

---

Modem:

Type	v.92 56K MDC
Controller	softmodem
Interface	internal AC '97 bus
Network adapter	10/100/1000 Ethernet LAN on system board
Wireless (optional)	internal Mini PCI Wi-Fi (802.11b and 802.11a) wireless support; Bluetooth™

---

**Video**

---

Video type	64-bit hardware accelerated
Data bus	4X AGP
Video controller	ATI Mobility RADEON 9000
Video memory	32 MB or 64 MB
LCD interface	LVDS
TV support	NTSC or PAL in S-video and composite modes

---

**Audio**

---

Audio type	compatible with Soundblaster and Microsoft® Windows® Sound System
Audio controller	Intel AC '97
Stereo conversion	20-bit (stereo digital-to-analog); 18-bit (stereo analog-to-digital)

---

**Audio (continued)**

---

## Interfaces:

Internal	AC '97
External	microphone miniconnector, stereo headphones/speakers miniconnector
Speaker	two 4-ohm speakers
Internal speaker amplifier	2-W channel into 4 ohms
Volume controls	keyboard shortcuts or program menus

---

**Display**

---

Type (active-matrix TFT)	XGA or SXGA+
Dimensions:	
Height	214.3 mm (8.4 inches)
Width	285.7 mm (11.3 inches)
Diagonal	357.1 mm (14.1 inches)
Maximum resolutions	1024 x 768 at 16.8 million colors (XGA); 1400 x 1050 at 16.8 million colors (SXGA+)
Response time (typical)	20-ms rise (maximum); 30-ms fall (maximum)
Refresh rate	60 Hz
Operating angle	0° (closed) to 180°
Viewing angles:	
Horizontal	±40°
Vertical	+10°/-30°
Pixel pitch	0.28 x 0.28 mm (XGA); 0.20 x 0.20 mm (SXGA+)

---

**Display (continued)**

---

## Power Consumption:

Panel with backlight (typical)	6.5 W (XGA); 7.0 W (SXGA+)
--------------------------------	-------------------------------

Controls	brightness can be controlled through keyboard shortcuts
----------	---

---

**Keyboard**

---

Number of keys	87 (U.S. and Canada); 88 (Europe); 91 (Japan)
Key travel	2.7 mm $\pm$ 0.3 mm (0.11 inch $\pm$ 0.016 inch)
Key spacing	19.05 mm $\pm$ 0.3 mm (0.75 inch $\pm$ 0.012 inch)
Layout	QWERTY/AZERTY/Kanji

---

**Touch Pad**

---

X/Y position resolution (graphics table mode)	240 cpi
Size:	
Width	64.88-mm (2.55-inch) sensor-active area
Height	48.88-mm (1.92-inch) rectangle

---

**Battery**

---

Type	6 cell, "smart" lithium ion (48 WHr); 4 cell, "smart" lithium ion (32 WHr)
Dimensions:	
Depth	77.5 mm (3.05 inches)
Height	19.1 mm (0.75 inch)
Width	123.4 mm (4.86 inches)
Weight	0.32 kg (0.7 lb) (6-cell battery); 0.23 kg (.5 lb) (4-cell battery)
Voltage	14.8 VDC

---

**Battery (continued)**

---

Charge time with computer off (approximate)	approximately 2 hours
Operating time	approximately 3 to 4 hours (6-cell battery); approximately 2 to 3 hours (4-cell battery) <b>NOTE:</b> Battery operating time can be significantly reduced under certain power-intensive conditions. See page 46 for more information on battery life.
Life span (approximate)	300 discharge/charge cycles
Temperature range:	
Operating	0° to 35°C (32° to 95°F)
Storage	-40° to 65°C (-40° to 149°F)

---

**AC Adapter**

---

Input voltage	90–264 VAC
Input current (maximum)	1.7 A
Input frequency	47–63 Hz
Output current	5.5 A (maximum at 4-second pulse); 4.5 A (continuous)
Output power	90 W or 65 W
Rated output voltage	19.5 VDC
Dimensions:	
Height	27.94 mm (1.1 inches)
Width	58.42 mm (2.3 inches)
Depth	133.85 mm (5.25 inches)
Weight (with cables)	0.4 kg (0.9 lb)
Temperature range:	
Operating	0° to 35°C (32° to 95°F)
Storage	-40° to 65°C (-40° to 149°F)

---

**Physical**

---

Height	30.8 mm (1.2 inches)
Width	315 mm (12.4 inches)
Depth	259.4 mm (10.2 inches)
Weight:	
With travel module	2.26 kg (4.98 lb)
With CD drive	2.4 kg (5.3 lb)

---

**Environmental**

---

Temperature range:

Operating	0° to 35°C (32° to 95°F)
Storage	-40° to 65°C (-40° to 149°F)

Relative humidity (maximum):

Operating	10% to 90% (noncondensing)
Storage	5% to 95% (noncondensing)

Maximum vibration (using a random-vibration spectrum that simulates user environment):

Operating	0.66 GRMS
Storage	1.30 GRMS

Maximum shock (measured with hard drive in head-parked position and a 2-ms half-sine pulse):

Operating	122 G
Storage	163 G

Altitude (maximum):

Operating	-15.2 to 3048 m (-50 to 10,000 ft)
Storage	-15.2 to 10,668 m (-50 to 35,000 ft)

# Standard Settings

 **NOTICE:** Unless you are an expert computer user or are directed to do so by Dell technical support, do not change the settings for this program. Certain changes might make your computer work incorrectly.

## Viewing the System Setup Screens

- 1 Turn on (or restart) your computer.
- 2 When the DELL™ logo appears, press  immediately. If you wait too long and the Windows logo appears, continue to wait until you see the Windows desktop. Then shut down your computer (see "Turning Off Your Computer" on page 43) and try again.

## System Setup Screens

The system setup screens display the current setup information and settings for your computer. On each screen, the system setup options are listed at the left of the screen. To the right of each option is the setting or value for that option. You can change settings that appear as white type on the screen. Options or values that you cannot change (because they are determined by the computer) appear less bright.

The upper-right corner of the screen displays help information for the currently highlighted option; the lower-right corner displays information about the computer. System setup key functions are listed across the bottom of the screen.

The screens display such information as:

- System configuration
- Boot order
- Boot (start-up) configuration and docking-device configuration settings
- Basic device configuration settings
- Battery charge status
- System security and hard-drive password settings

 **NOTE:** To see information about a specific item on a system setup screen, highlight the item and refer to the **Help** area on the screen.

## Commonly Used Options

Certain options require that you reboot the computer for new settings to take effect.

### Changing the Boot Sequence

The *boot sequence*, or *boot order*, tells the computer where to look to find the software needed to start the operating system. You can control the boot sequence using the **Boot Order** page of the system setup program. The **Boot Order** page displays a general list of the bootable devices that may be installed in your computer, including but not limited to the following:

- Diskette Drive
- Modular bay HDD
- Internal HDD
- CD/DVD/CD-RW drive

During the boot routine, the computer starts at the top of the list and scans each enabled device for the operating system start-up files. When the computer finds the files, it stops searching and starts the operating system.

To control the boot devices, select (highlight) a device by pressing the



or  key, and then enable or disable the device or change its order in the list.



- To enable or disable a device, highlight the item and press

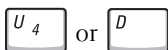

. Enabled items appear as white and display a small triangle to their left; disabled items appear blue or dimmed without a triangle.

- To reorder a device in the list, highlight the device and then press





 or  (not case-sensitive) to move the highlighted device up or down.

Boot sequence changes take effect as soon as you save the changes and exit the system setup program.

## Performing a One-Time Boot

You can set a one-time-only boot sequence without entering the system setup program. (You can also use this procedure to boot the Dell Diagnostics on the diagnostics utility partition on your hard drive.)

- 1 Shut down the computer.
- 2 Connect the computer to an electrical outlet.
- 3 Turn on the computer. When the DELL logo appears, press  immediately. If you wait too long and the Windows logo appears, continue to wait until you see the Windows desktop. Then shut down your computer and try again.
- 4 When the boot device list appears, highlight the device from which you want to boot and press .

The computer boots to the selected device.

The next time you reboot the computer, the normal boot order is restored.

## Changing Printer Modes

Set the **Parallel Mode** option according to the type of printer or device connected to the parallel connector. To determine the correct mode to use, see the documentation that came with the device.



Setting **Parallel Mode** to **Disabled** disables the parallel port and the port's LPT address, freeing its interrupt for another device to use.

## Changing COM Ports

**Serial Port** allows you to map the serial port COM address or disable the serial port and its address, freeing its interrupt for another device to use.

## Enabling the Infrared Sensor

- 1 Enter the system setup program:
  - a Turn on your computer.
  - b Press  when the DELL logo appears.

- 2 Press   until you locate **Infrared Data Port** under **Basic Device Configuration**.
- 3 Press the down-arrow key to highlight **Disabled** next to **Infrared Data Port**.
- 4 Press the right-arrow key to change the setting to a COM port.  
Ensure that the COM port that you select is different from the COM port assigned to the serial connector.
- 5 Press the down-arrow key to select **Infrared Mode**, and press the right-arrow key to change the setting to **Fast IR** or **Slow IR**.  
It is recommended that you use **Fast IR**. If the infrared device cannot communicate with your computer, turn off the computer and repeat steps 1 through 5 to change the setting to **Slow IR**.
- 6 Press  to save the changes and exit the system setup program.  
If you are prompted to restart your computer, click **Yes**.
- 7 Follow the instructions on the screen while the infrared sensor driver is being installed.
- 8 At the end of the installation process, click **Yes** to restart the computer.



**NOTE:** If the infrared device cannot communicate with your computer after you repeat steps 1 through 5 to change the system setup program setting to **Slow IR**, contact the infrared device manufacturer.

After you enable the infrared sensor, you can use it to establish a link to an infrared device. To set up and use an infrared device, see the infrared device documentation and the Windows Help and Support Center.

## Dell Technical Support Policy (U.S. Only)

Technician-assisted technical support requires the cooperation and participation of the customer in the troubleshooting process and provides for restoration of the operating system, application software, and hardware drivers to the original default configuration as shipped from Dell, as well as the verification of appropriate functionality of the computer and all Dell-installed hardware. In addition to this technician-assisted technical support, online technical support is available at [support.dell.com](http://support.dell.com). Additional technical support options may be available for purchase.

Dell provides limited technical support for the computer and any "Dell-installed" software and peripherals<sup>1</sup>. Support for third-party software and peripherals is provided by the original manufacturer, including those purchased and/or installed through Dell Software and Peripherals, Readyware, and Custom Factory Integration<sup>2</sup>.

<sup>1</sup> Repair services are provided pursuant to the terms and conditions of your limited warranty and any optional support service contract purchased with the computer.

<sup>2</sup> All Dell-standard components included in a Custom Factory Integration (CFI) project are covered by the standard Dell limited warranty for your computer. However, Dell also extends a parts replacement program to cover all nonstandard, third-party hardware components integrated through CFI for the duration of the computer's service contract.

### **Definition of "Dell-Installed" Software and Peripherals**

Dell-installed software includes the operating system and some of the application software that is preinstalled on the computer during the manufacturing process (Microsoft Office, Norton Antivirus, and so on).

Dell-installed peripherals include any internal expansion cards, or Dell-branded module bay or PC Card accessories. In addition, any Dell-branded monitors, keyboards, mice, speakers, microphones for telephonic modems, docking stations/port replicators, networking products, and all associated cabling are included.

### **Definition of "Third-Party" Software and Peripherals**

Third-party software and peripherals include any peripheral, accessory, or application software sold by Dell not under the Dell brand (printers, scanners, cameras, games, and so on). Support for all third-party software and peripherals is provided by the original manufacturer of the product.

## **Contacting Dell**

To contact Dell electronically, you can access the following websites:

- [www.dell.com](http://www.dell.com)
- [support.dell.com](http://support.dell.com) (technical support)

- [premiersupport.dell.com](http://premiersupport.dell.com) (technical support for educational, government, healthcare, and medium/large business customers, including Premier, Platinum, and Gold customers)

For specific web addresses for your country, find the appropriate country section in the table below.

**NOTE:** Toll-free numbers are for use within the country for which they are listed.

When you need to contact Dell, use the electronic addresses, telephone numbers, and codes provided in the following table. If you need assistance in determining which codes to use, contact a local or an international operator.

<b>Country (City) International Access Code Country Code City Code</b>	<b>Department Name or Service Area, Website and E-Mail Address</b>	<b>Area Codes, Local Numbers, and Toll-Free Numbers</b>
Anguilla	General Support	toll-free: 800-335-0031
Antigua and Barbuda	General Support	1-800-805-5924
Argentina (Buenos Aires)	Website: <a href="http://www.dell.com.ar">www.dell.com.ar</a>	
International Access Code: 00	Tech Support and Customer Care	toll-free: 0-800-444-0733
Country Code: 54	Sales	0-810-444-3355
City Code: 11	Tech Support Fax	11 4515 7139
	Customer Care Fax	11 4515 7138
Aruba	General Support	toll-free: 800-1578
Australia (Sydney)	E-mail (Australia): <a href="mailto:au_tech_support@dell.com">au_tech_support@dell.com</a>	
International Access Code: 0011	E-mail (New Zealand): <a href="mailto:nz_tech_support@dell.com">nz_tech_support@dell.com</a>	
Country Code: 61	Home and Small Business	1-300-65-55-33
City Code: 2	Government and Business	toll-free: 1-800-633-559
	Preferred Accounts Division (PAD)	toll-free: 1-800-060-889
	Customer Care	toll-free: 1-800-819-339
	Corporate Sales	toll-free: 1-800-808-385
	Transaction Sales	toll-free: 1-800-808-312
	Fax	toll-free: 1-800-818-341

<b>Country (City) International Access Code Country Code City Code</b>	<b>Department Name or Service Area, Website and E-Mail Address</b>	<b>Area Codes, Local Numbers, and Toll-Free Numbers</b>
Austria (Vienna)	Website: <a href="http://support.euro.dell.com">support.euro.dell.com</a>	
International Access Code: 900	E-mail: <a href="mailto:tech_support_central_europe@dell.com">tech_support_central_europe@dell.com</a>	
Country Code: 43	Home/Small Business Sales	01 795 67602
City Code: 1	Home/Small Business Fax	01 795 67605
	Home/Small Business Customer Care	01 795 67603
	Preferred Accounts/Corporate Customer Care	0660 8056
	Home/Small Business Technical Support	01 795 67604
	Preferred Accounts/Corporate Technical Support	0660 8779
	Switchboard	01 491 04 0
<b>Bahamas</b>	General Support	toll-free: 1-866-278-6818
<b>Barbados</b>	General Support	1-800-534-3066
Belgium (Brussels)	Website: <a href="http://support.euro.dell.com">support.euro.dell.com</a>	
International Access Code: 00	E-mail: <a href="mailto:tech_be@dell.com">tech_be@dell.com</a>	
Country Code: 32	E-mail for French Speaking Customers: <a href="http://support.euro.dell.com/be/fr/emailldell/">support.euro.dell.com/be/fr/emailldell/</a>	
City Code: 2	Technical Support	02 481 92 88
	Customer Care	02 481 91 19
	Home/Small Business Sales	toll-free: 0800 16884
	Corporate Sales	02 481 91 00
	Fax	02 481 92 99
	Switchboard	02 481 91 00
<b>Bermuda</b>	General Support	1-800-342-0671
<b>Bolivia</b>	General Support	toll-free: 800-10-0238
Brazil	Website: <a href="http://www.dell.com/br">www.dell.com/br</a>	
International Access Code: 00	Customer Support, Technical Support	0800 90 3355
Country Code: 55	Tech Support Fax	51 481 5470
City Code: 51	Customer Care Fax	51 481 5480
	Sales	0800 90 3390
<b>British Virgin Islands</b>	General Support	toll-free: 1-866-278-6820

<b>Country (City) International Access Code Country Code City Code</b>	<b>Department Name or Service Area, Website and E-Mail Address</b>	<b>Area Codes, Local Numbers, and Toll-Free Numbers</b>
<b>Brunei</b>	Customer Technical Support (Penang, Malaysia)	604 633 4966
Country Code: 673	Customer Service (Penang, Malaysia)	604 633 4949
	Transaction Sales (Penang, Malaysia)	604 633 4955
<b>Canada (North York, Ontario)</b>	Automated Order-Status System	toll-free: 1-800-433-9014
International Access Code: 011	AutoTech (automated technical support)	toll-free: 1-800-247-9362
	TechFax	toll-free: 1-800-950-1329
	Customer Care (home/small business)	toll-free: 1-800-847-4096
	Customer Care (med./large business, government)	toll-free: 1-800-326-9463
	Technical Support (home/small business)	toll-free: 1-800-847-4096
	Technical Support (med./large bus., government)	toll-free: 1-800-847-4096
	Sales (direct sales—from outside Toronto)	toll-free: 1-800-387-5752
	Sales (direct sales—from within Toronto)	416 758-2200
	Sales (federal government, education, and medical)	toll-free: 1-800-567-7542
<b>Cayman Islands</b>	General Support	1-800-805-7541
<b>Chile (Santiago)</b>	Sales, Customer Support, and Technical Support	toll-free: 1230-020-4823
Country Code: 56		
City Code: 2		

<b>Country (City) International Access Code Country Code City Code</b>	<b>Department Name or Service Area, Website and E-Mail Address</b>	<b>Area Codes, Local Numbers, and Toll-Free Numbers</b>
China (Xiamen) Country Code: 86 City Code: 592	Tech Support website: <a href="http://support.ap.dell.com/china">support.ap.dell.com/china</a> Tech Support E-mail: <a href="mailto:cn_support@dell.com">cn_support@dell.com</a> Tech Support Fax Home and Small Business Technical Support Corporate Accounts Technical Support Customer Experience Home and Small Business Preferred Accounts Division Large Corporate Accounts GCP Large Corporate Accounts Key Accounts Large Corporate Accounts North Large Corporate Accounts North Government and Education Large Corporate Accounts East Large Corporate Accounts East Government and Education Large Corporate Accounts Queue Team Large Corporate Accounts South Large Corporate Accounts West Large Corporate Accounts Spare Parts	818 1350 toll-free: 800 858 2437 toll-free: 800 858 2333 toll-free: 800 858 2060 toll-free: 800 858 2222 toll-free: 800 858 2062 toll-free: 800 858 2055 toll-free: 800 858 2628 toll-free: 800 858 2999 toll-free: 800 858 2955 toll-free: 800 858 2020 toll-free: 800 858 2669 toll-free: 800 858 2572 toll-free: 800 858 2355 toll-free: 800 858 2811 toll-free: 800 858 2621
Colombia	General Support	980-9-15-3978
Costa Rica	General Support	0800-012-0435
Czech Republic (Prague) International Access Code: 00 Country Code: 420 City Code: 2	Website: <a href="http://support.euro.dell.com">support.euro.dell.com</a> E-mail: <a href="mailto:czech_dell@dell.com">czech_dell@dell.com</a> Technical Support Customer Care Fax TechFax Switchboard	02 22 83 27 27 02 22 83 27 11 02 22 83 27 14 02 22 83 27 28 02 22 83 27 11

<b>Country (City) International Access Code Country Code City Code</b>	<b>Department Name or Service Area, Website and E-Mail Address</b>	<b>Area Codes, Local Numbers, and Toll-Free Numbers</b>
Denmark (Copenhagen) International Access Code: 00 Country Code: 45	Website: <a href="http://support.euro.dell.com">support.euro.dell.com</a> E-mail Support (portable computers): <a href="mailto:den_nbk_support@dell.com">den_nbk_support@dell.com</a> E-mail Support (desktop computers): <a href="mailto:den_support@dell.com">den_support@dell.com</a> E-mail Support (servers): <a href="mailto:Nordic_server_support@dell.com">Nordic_server_support@dell.com</a>	
	Technical Support	7023 0182
	Customer Care (Relational)	7023 0184
	Home/Small Business Customer Care	3287 5505
	Switchboard (Relational)	3287 1200
	Fax Switchboard (Relational)	3287 1201
	Switchboard (Home/Small Business)	3287 5000
	Fax Switchboard (Home/Small Business)	3287 5001
<b>Dominica</b>	General Support	toll-free: 1-866-278-6821
<b>Dominican Republic</b>	General Support	1-800-148-0530
<b>Ecuador</b>	General Support	toll-free: 999-119
<b>El Salvador</b>	General Support	01-899-753-0777
Finland (Helsinki) International Access Code: 990 Country Code: 358 City Code: 9	Website: <a href="http://support.euro.dell.com">support.euro.dell.com</a> E-mail: <a href="mailto:fin_support@dell.com">fin_support@dell.com</a> E-mail Support (servers): <a href="mailto:Nordic_support@dell.com">Nordic_support@dell.com</a>	
	Technical Support	09 253 313 60
	Technical Support Fax	09 253 313 81
	Relational Customer Care	09 253 313 38
	Home/Small Business Customer Care	09 693 791 94
	Fax	09 253 313 99
	Switchboard	09 253 313 00

<b>Country (City) International Access Code Country Code City Code</b>	<b>Department Name or Service Area, Website and E-Mail Address</b>	<b>Area Codes, Local Numbers, and Toll-Free Numbers</b>
France (Paris) (Montpellier)	Website: <a href="http://support.euro.dell.com">support.euro.dell.com</a>	
International Access Code: 00	E-mail: <a href="mailto:support.euro.dell.com/fr/fr/emaildell/">support.euro.dell.com/fr/fr/emaildell/</a>	
Country Code: 33	<b>Home and Small Business</b>	
City Codes: (1) (4)	Technical Support	0825 387 270
	Customer Care	0825 823 833
	Switchboard	0825 004 700
	Switchboard (calls from outside of France)	04 99 75 40 00
	Sales	0825 004 700
	Fax	0825 004 701
	Fax (calls from outside of France)	04 99 75 40 01
	<b>Corporate</b>	
	Technical Support	0825 004 719
	Customer Care	0825 338 339
	Switchboard	01 55 94 71 00
	Sales	01 55 94 71 00
	Fax	01 55 94 71 01
<b>Germany (Langen)</b>	Website: <a href="http://support.euro.dell.com">support.euro.dell.com</a>	
International Access Code: 00	E-mail: <a href="mailto:tech_support_central_europe@dell.com">tech_support_central_europe@dell.com</a>	
Country Code: 49	Technical Support	06103 766-7200
City Code: 6103	Home/Small Business Customer Care	0180-5-224400
	Global Segment Customer Care	06103 766-9570
	Preferred Accounts Customer Care	06103 766-9420
	Large Accounts Customer Care	06103 766-9560
	Public Accounts Customer Care	06103 766-9555
	Switchboard	06103 766-7000
<b>Grenada</b>	General Support	toll-free: 1-866-540-3355
<b>Guatemala</b>	General Support	1-800-999-0136
<b>Guyana</b>	General Support	toll-free: 1-877-270-4609

<b>Country (City) International Access Code Country Code City Code</b>	<b>Department Name or Service Area, Website and E-Mail Address</b>	<b>Area Codes, Local Numbers, and Toll-Free Numbers</b>
<b>Hong Kong</b>	Technical Support (Dimension™ and Inspiron™)	296 93188
International Access Code: 001 Country Code: 852	Technical Support (OptiPlex™, Latitude™, and Dell Precision™)	296 93191
	Customer Service (non-technical, post-sales issues)	800 93 8291
	Transaction Sales	toll-free: 800 96 4109
	Large Corporate Accounts HK	toll-free: 800 96 4108
	Large Corporate Accounts GCP HK	toll-free: 800 90 3708
<b>India</b>	Technical Support	1600 33 8045
	Sales	1600 33 8044
<b>Ireland (Cherrywood)</b>	Website: <a href="http://support.euro.dell.com">support.euro.dell.com</a>	
International Access Code: 16 Country Code: 353 City Code: 1	E-mail: <a href="mailto:dell_direct_support@dell.com">dell_direct_support@dell.com</a>	
	Ireland Technical Support	1850 543 543
	U.K. Technical Support (dial within U.K. only)	0870 908 0800
	Home User Customer Care	01 204 4095
	Small Business Customer Care	01 204 4444
	U.K. Customer Care (dial within U.K. only)	0870 906 0010
	Corporate Customer Care	01 204 4003
	Ireland Sales	01 204 4444
	U.K. Sales (dial within U.K. only)	0870 907 4000
	SalesFax	01 204 0144
	Fax	01 204 5960
	Switchboard	01 204 4444

<b>Country (City) International Access Code Country Code City Code</b>	<b>Department Name or Service Area, Website and E-Mail Address</b>	<b>Area Codes, Local Numbers, and Toll-Free Numbers</b>
Italy (Milan)	Website: support.euro.dell.com	
International Access Code: 00	E-mail: support.euro.dell.com/it/it/emaildell/	
Country Code: 39	<b>Home and Small Business</b>	
City Code: 02	Technical Support	02 577 826 90
	Customer Care	02 696 821 14
	Fax	02 696 821 13
	Switchboard	02 696 821 12
	<b>Corporate</b>	
	Technical Support	02 577 826 90
	Customer Care	02 577 825 55
	Fax	02 575 035 30
	Switchboard	02 577 821
<b>Jamaica</b>	General Support (dial from within Jamaica only)	1-800-682-3639

<b>Country (City) International Access Code Country Code City Code</b>	<b>Department Name or Service Area, Website and E-Mail Address</b>	<b>Area Codes, Local Numbers, and Toll-Free Numbers</b>
<b>Japan (Kawasaki)</b>	Website: <a href="http://support.jp.dell.com">support.jp.dell.com</a>	
International Access Code: 001	Technical Support (servers)	toll-free: 0120-198-498
Country Code: 81	Technical Support outside of Japan (servers)	81-44-556-4162
City Code: 44	Technical Support (Dimension™ and Inspiron™)	toll-free: 0120-198-226
	Technical Support outside of Japan (Dimension and Inspiron)	81-44-520-1435
	Technical Support (Dell Precision™, OptiPlex™, and Latitude™)	toll-free: 0120-198-433
	Technical Support outside of Japan (Dell Precision, OptiPlex, and Latitude)	81-44-556-3894
	24-Hour Automated Order Service	044-556-3801
	Customer Care	044-556-4240
	Business Sales Division (up to 400 employees)	044-556-1465
	Preferred Accounts Division Sales (over 400 employees)	044-556-3433
	Large Corporate Accounts Sales (over 3500 employees)	044-556-3430
	Public Sales (government agencies, educational institutions, and medical institutions)	044-556-1469
	Global Segment Japan	044-556-3469
	Individual User	044-556-1760
	Faxbox Service	044-556-3490
	Switchboard	044-556-4300
<b>Korea (Seoul)</b>	Technical Support	toll-free: 080-200-3800
International Access Code: 001	Sales	toll-free: 080-200-3600
Country Code: 82	Customer Service (Seoul, Korea)	toll-free: 080-200-3800
City Code: 2	Customer Service (Penang, Malaysia)	604 633 4949
	Fax	2194-6202
	Switchboard	2194-6000

<b>Country (City) International Access Code Country Code City Code</b>	<b>Department Name or Service Area, Website and E-Mail Address</b>	<b>Area Codes, Local Numbers, and Toll-Free Numbers</b>
Latin America	Customer Technical Support (Austin, Texas, U.S.A.)	512 728-4093
	Customer Service (Austin, Texas, U.S.A.)	512 728-3619
	Fax (Technical Support and Customer Service) (Austin, Texas, U.S.A.)	512 728-3883
	Sales (Austin, Texas, U.S.A.)	512 728-4397
	SalesFax (Austin, Texas, U.S.A.)	512 728-4600 or 512 728-3772
<b>Luxembourg</b>	Website: <a href="http://support.euro.dell.com">support.euro.dell.com</a>	
International Access Code: 00	E-mail: <a href="mailto:tech_be@dell.com">tech_be@dell.com</a>	
Country Code: 352	Technical Support (Brussels, Belgium)	02 481 92 88
	Home/Small Business Sales (Brussels, Belgium)	toll-free: 080016884
	Corporate Sales (Brussels, Belgium)	02 481 91 00
	Customer Care (Brussels, Belgium)	02 481 91 19
	Fax (Brussels, Belgium)	02 481 92 99
	Switchboard (Brussels, Belgium)	02 481 91 00
<b>Macao</b>	Technical Support	toll-free: 0800 582
Country Code: 853	Customer Service (Penang, Malaysia)	604 633 4949
	Transaction Sales	toll-free: 0800 581
<b>Malaysia (Penang)</b>	Technical Support	toll-free: 1 800 888 298
International Access Code: 00	Customer Service	04 633 4949
Country Code: 60	Transaction Sales	toll-free: 1 800 888 202
City Code: 4	Corporate Sales	toll-free: 1 800 888 213

<b>Country (City) International Access Code Country Code City Code</b>	<b>Department Name or Service Area, Website and E-Mail Address</b>	<b>Area Codes, Local Numbers, and Toll-Free Numbers</b>
Mexico	Customer Technical Support	001-877-384-8979
International Access Code: 00		or 001-877-269-3383
Country Code: 52	Sales	50-81-8800
		or 01-800-888-3355
	Customer Service	001-877-384-8979
		or 001-877-269-3383
	Main	50-81-8800
		or 01-800-888-3355
Montserrat	General Support	toll-free: 1-866-278-6822
Netherlands Antilles	General Support	001-800-882-1519
Netherlands (Amsterdam)	Website: <a href="http://support.euro.dell.com">support.euro.dell.com</a>	
International Access Code: 00	E-mail (Technical Support):	
Country Code: 31	(Enterprise): <a href="mailto:nl_server_support@dell.com">nl_server_support@dell.com</a>	
City Code: 20	(Latitude): <a href="mailto:nl_latitude_support@dell.com">nl_latitude_support@dell.com</a>	
	(Inspiron): <a href="mailto:nl_inspiron_support@dell.com">nl_inspiron_support@dell.com</a>	
	(Dimension): <a href="mailto:nl_dimension_support@dell.com">nl_dimension_support@dell.com</a>	
	(OptiPlex): <a href="mailto:nl_optiplex_support@dell.com">nl_optiplex_support@dell.com</a>	
	(Dell Precision): <a href="mailto:nl_workstation_support@dell.com">nl_workstation_support@dell.com</a>	
	Technical Support	020 674 45 00
	Technical Support Fax	020 674 47 66
	Home/Small Business Customer Care	020 674 42 00
	Relational Customer Care	020 674 4325
	Home/Small Business Sales	020 674 55 00
	Relational Sales	020 674 50 00
	Home/Small Business Sales Fax	020 674 47 75
	Relational Sales Fax	020 674 47 50
	Switchboard	020 674 50 00
	Switchboard Fax	020 674 47 50

<b>Country (City) International Access Code Country Code City Code</b>	<b>Department Name or Service Area, Website and E-Mail Address</b>	<b>Area Codes, Local Numbers, and Toll-Free Numbers</b>
New Zealand	E-mail (New Zealand): nz_tech_support@dell.com	
International Access Code: 00	E-mail (Australia): au_tech_support@dell.com	
Country Code: 64	Home and Small Business	0800 446 255
	Government and Business	0800 444 617
	Sales	0800 441 567
	Fax	0800 441 566
Nicaragua	General Support	001-800-220-1006
Norway (Lysaker)	Website: support.euro.dell.com	
International Access Code: 00	E-mail Support (portable computers):	
Country Code: 47	nor_nbk_support@dell.com	
	E-mail Support (desktop computers):	
	nor_support@dell.com	
	E-mail Support (servers):	
	nordic_server_support@dell.com	
	Technical Support	671 16882
	Relational Customer Care	671 17514
	Home/Small Business Customer Care	23162298
	Switchboard	671 16800
	Fax Switchboard	671 16865
Panama	General Support	001-800-507-0962
Peru	General Support	0800-50-669
Poland (Warsaw)	Website: support.euro.dell.com	
International Access Code: 011	E-mail: pl_support@dell.com	
Country Code: 48	Customer Service Phone	57 95 700
City Code: 22	Customer Care	57 95 999
	Sales	57 95 999
	Customer Service Fax	57 95 806
	Reception Desk Fax	57 95 998
	Switchboard	57 95 999

<b>Country (City) International Access Code Country Code City Code</b>	<b>Department Name or Service Area, Website and E-Mail Address</b>	<b>Area Codes, Local Numbers, and Toll-Free Numbers</b>
<b>Portugal</b>	E-mail: <a href="mailto:support.euro.dell.com/es/es/emaildell/">support.euro.dell.com/es/es/emaildell/</a>	
International Access Code: 00	Technical Support	800 834 077
Country Code: 35	Customer Care	800 300 415 or 800 834 075
	Sales	800 300 410 or 800 300 411 or 800 300 412 or 121 422 07 10
	Fax	121 424 01 12
<b>Puerto Rico</b>	General Support	1-800-805-7545
<b>St. Kitts and Nevis</b>	General Support	toll-free: 1-877-441-4731
<b>St. Lucia</b>	General Support	1-800-882-1521
<b>St. Vincent and the Grenadines</b>	General Support	toll-free: 1-877-270-4609
<b>Singapore (Singapore)</b>	Technical Support	toll-free: 800 6011 051
International Access Code: 005	Customer Service (Penang, Malaysia)	604 633 4949
Country Code: 65	Transaction Sales	toll-free: 800 6011 054
	Corporate Sales	toll-free: 800 6011 053
<b>South Africa (Johannesburg)</b>	Website: <a href="http://support.euro.dell.com">support.euro.dell.com</a>	
International Access Code: 09/091	E-mail: <a href="mailto:dell_za_support@dell.com">dell_za_support@dell.com</a>	
	Technical Support	011 709 7710
Country Code: 27	Customer Care	011 709 7707
City Code: 11	Sales	011 709 7700
	Fax	011 706 0495
	Switchboard	011 709 7700
<b>Southeast Asian and Pacific Countries</b>	Customer Technical Support, Customer Service, and Sales (Penang, Malaysia)	604 633 4810

<b>Country (City) International Access Code Country Code City Code</b>	<b>Department Name or Service Area, Website and E-Mail Address</b>	<b>Area Codes, Local Numbers, and Toll-Free Numbers</b>
Spain (Madrid)	Website: <a href="http://support.euro.dell.com">support.euro.dell.com</a>	
International Access Code: 00	E-mail: <a href="mailto:support.euro.dell.com/es/es/emaildell/">support.euro.dell.com/es/es/emaildell/</a>	
Country Code: 34	<b>Home and Small Business</b>	
City Code: 91	Technical Support	902 100 130
	Customer Care	902 118 540
	Sales	902 118 541
	Switchboard	902 118 541
	Fax	902 118 539
	<b>Corporate</b>	
	Technical Support	902 100 130
	Customer Care	902 118 546
	Switchboard	91 722 92 00
	Fax	91 722 95 83
Sweden (Upplands Vasby)	Website: <a href="http://support.euro.dell.com">support.euro.dell.com</a>	
International Access Code: 00	E-mail: <a href="mailto:swe_support@dell.com">swe_support@dell.com</a>	
Country Code: 46	E-mail Support for Latitude and Inspiron: <a href="mailto:Swe-nbk_kats@dell.com">Swe-nbk_kats@dell.com</a>	
City Code: 8	E-mail Support for OptiPlex: <a href="mailto:Swe_kats@dell.com">Swe_kats@dell.com</a>	
	E-mail Support for Servers: <a href="mailto:Nordic_server_support@dell.com">Nordic_server_support@dell.com</a>	
	Technical Support	08 590 05 199
	Relational Customer Care	08 590 05 642
	Home/Small Business Customer Care	08 587 70 527
	Employee Purchase Program (EPP) Support	20 140 14 44
	Fax Technical Support	08 590 05 594
	Sales	08 590 05 185

<b>Country (City) International Access Code Country Code City Code</b>	<b>Department Name or Service Area, Website and E-Mail Address</b>	<b>Area Codes, Local Numbers, and Toll-Free Numbers</b>
Switzerland (Geneva) International Access Code: 00 Country Code: 41 City Code: 22	Website: <a href="http://support.euro.dell.com">support.euro.dell.com</a> E-mail: <a href="mailto:swisstech@dell.com">swisstech@dell.com</a> E-mail for French-speaking HSB and Corporate Customers: <a href="http://support.euro.dell.com/ch/fr/emaildell/">support.euro.dell.com/ch/fr/emaildell/</a> Technical Support (Home and Small Business) Technical Support (Corporate) Customer Care (Home and Small Business) Customer Care (Corporate) Fax Switchboard	0844 811 411 0844 822 844 0848 802 202 0848 821 721 022 799 01 90 022 799 01 01
Taiwan International Access Code: 002 Country Code: 886	Technical Support (portable and desktop computers) Technical Support (servers) Transaction Sales  Corporate Sales	toll-free: 00801 86 1011 toll-free: 0080 60 1256 toll-free: 0080 651 228 or 0800 33 556 toll-free: 0080 651 227 or 0800 33 555
Thailand International Access Code: 001 Country Code: 66	Technical Support Customer Service (Penang, Malaysia) Sales	toll-free: 0880 060 07 604 633 4949 toll-free: 0880 060 09
Trinidad/Tobago	General Support	1-800-805-8035
Turks and Caicos Islands	General Support	toll-free: 1-866-540-3355

<b>Country (City) International Access Code Country Code City Code</b>	<b>Department Name or Service Area, Website and E-Mail Address</b>	<b>Area Codes, Local Numbers, and Toll-Free Numbers</b>
U.K. (Bracknell)	Website: <a href="http://support.euro.dell.com">support.euro.dell.com</a>	
International Access Code: 00	Customer Care website: <a href="http://dell.co.uk/lca/customerservices">dell.co.uk/lca/customerservices</a>	
Country Code: 44	E-mail: <a href="mailto:dell_direct_support@dell.com">dell_direct_support@dell.com</a>	
City Code: 1344	Technical Support (Corporate/Preferred Accounts/PAD [1000+ employees])	0870 908 0500
	Technical Support (direct/PAD and general)	0870 908 0800
	Global Accounts Customer Care	01344 373 185 or 01344 373 186
	Home and Small Business Customer Care	0870 906 0010
	Corporate Customer Care	0870 908 0500
	Preferred Accounts (500–5000 employees) Customer Care	01344 373 196
	Central Government Customer Care	01344 373 193
	Local Government & Education Customer Care	01344 373 199
	Health Customer Care	01344 373 194
	Home and Small Business Sales	0870 907 4000
	Corporate/Public Sector Sales	01344 860 456
<b>Uruguay</b>	General Support	toll-free: 000-413-598-2521

<b>Country (City) International Access Code Country Code City Code</b>	<b>Department Name or Service Area, Website and E-Mail Address</b>	<b>Area Codes, Local Numbers, and Toll-Free Numbers</b>
U.S.A. (Austin, Texas)	Automated Order-Status Service	toll-free: 1-800-433-9014
International Access Code: 011 Country Code: 1	AutoTech (portable and desktop computers)	toll-free: 1-800-247-9362
	<b>Consumer</b> (Home and Home Office)	
	Technical Support	toll-free: 1-800-624-9896
	Customer Service	toll-free: 1-800-624-9897
	DellNet™ Service and Support	toll-free: 1-877-Dellnet (1-877-335-5638)
	Employee Purchase Program (EPP) Customers	toll-free: 1-800-695-8133
	Financial Services website: <a href="http://www.dellfinancialservices.com">www.dellfinancialservices.com</a>	
	Financial Services (lease/loans)	toll-free: 1-877-577-3355
	Financial Services (Dell Preferred Accounts [DPA])	toll-free: 1-800-283-2210
	<b>Business</b>	
	Customer Service and Technical Support	toll-free: 1-800-822-8965
	Employee Purchase Program (EPP) Customers	toll-free: 1-800-695-8133
	Projectors Technical Support	toll-free: 1-877-459-7298
	<b>Public</b> (government, education, and healthcare)	
	Customer Service and Technical Support	toll-free: 1-800-456-3355
	Employee Purchase Program (EPP) Customers	toll-free: 1-800-234-1490
	Dell Sales	toll-free: 1-800-289-3355 or toll-free: 1-800-879-3355
	Dell Outlet Store (Dell refurbished computers)	toll-free: 1-888-798-7561
	Software and Peripherals Sales	toll-free: 1-800-671-3355
	Spare Parts Sales	toll-free: 1-800-357-3355
	Extended Service and Warranty Sales	toll-free: 1-800-247-4618
	Fax	toll-free: 1-800-727-8320
	Dell Services for the Deaf, Hard-of-Hearing, or Speech-Impaired	toll-free: 1-877-DELLTTY (1-877-335-5889)
U.S. Virgin Islands	General Support	1-877-673-3355
Venezuela	General Support	8001-3605

# Regulatory Notices

Electromagnetic Interference (EMI) is any signal or emission, radiated in free space or conducted along power or signal leads, that endangers the functioning of a radio navigation or other safety service or seriously degrades, obstructs, or repeatedly interrupts a licensed radio communications service. Radio communications services include but are not limited to AM/FM commercial broadcast, television, cellular services, radar, air-traffic control, pager, and Personal Communication Services (PCS). These licensed services, along with unintentional radiators such as digital devices, including computers, contribute to the electromagnetic environment.

Electromagnetic Compatibility (EMC) is the ability of items of electronic equipment to function properly together in the electronic environment. While this computer has been designed and determined to be compliant with regulatory agency limits for EMI, there is no guarantee that interference will not occur in a particular installation. If this equipment does cause interference with radio communications services, which can be determined by turning the equipment off and on, you are encouraged to try to correct the interference by one or more of the following measures:

- Reorient the receiving antenna.
- Relocate the computer with respect to the receiver.
- Move the computer away from the receiver.
- Plug the computer into a different outlet so that the computer and the receiver are on different branch circuits.

If necessary, consult a Dell Technical Support representative or an experienced radio/television technician for additional suggestions.

For additional regulatory information, see the *Tell Me How* help file that accompanied your computer. To access the help file, see "Accessing Help" on page 98.

## NOM Information (Mexico Only)

The following information is provided on the device(s) described in this document in compliance with the requirements of the official Mexican standards (NOM):

Exporter:	Dell Computer Corporation One Dell Way Round Rock, TX 78682
Importer:	Dell Computer de México, S.A. de C.V. Paseo de la Reforma 2620 - 11° Piso Col. Lomas Altas 11950 México, D.F.
Ship to:	Dell Computer de México, S.A. de C.V. al Cuidado de Kuehne & Nagel de México S. de R.I. Avenida Soles No. 55 Col. Peñon de los Baños 15520 México, D.F.
Model number:	PP05L
Supply voltage:	100–240 VAC
Frequency:	50–60 Hz
Current Consumption:	1.5 A
Output voltage:	19.5 VDC
Output current:	4.92 A

# Limited Warranties and Return Policy

Dell-branded hardware products purchased in the U.S. or Canada come with either a 90-day, 1-year, 2-year, 3-year, or 4-year limited warranty. To determine which warranty came with your hardware product(s), see your packing slip or invoice. The following sections describe the limited warranties and return policy for the U.S., the limited warranties and return policy for Canada, the manufacturer guarantee for Latin America and the Caribbean, and the Intel® Pentium® and Celeron® warranty for the U.S. and Canada.

## Limited Warranty for Dell-Branded Hardware Products (U.S. Only)

### What is covered by this limited warranty?

This limited warranty covers defects in materials and workmanship in your—our end-user customer's—Dell-branded hardware products, including Dell-branded peripheral products.

### What is not covered by this limited warranty?

This limited warranty does not cover:

- Software, including the operating system and software added to the Dell-branded hardware products through our factory-integration system, third-party software, or the reloading of software
- Non-Dell-branded and Solution Provider Direct products and accessories
- Problems that result from:
  - External causes such as accident, abuse, misuse, or problems with electrical power
  - Servicing not authorized by Dell
  - Usage that is not in accordance with product instructions
  - Failure to follow the product instructions or failure to perform preventive maintenance
  - Problems caused by using accessories, parts, or components not supplied by Dell
- Products with missing or altered Service Tags or serial numbers
- Products for which Dell has not received payment

THIS WARRANTY GIVES YOU SPECIFIC LEGAL RIGHTS, AND YOU MAY ALSO HAVE OTHER RIGHTS WHICH VARY FROM STATE TO STATE (OR JURISDICTION TO JURISDICTION). DELL'S RESPONSIBILITY FOR MALFUNCTIONS AND DEFECTS IN HARDWARE IS LIMITED TO REPAIR AND REPLACEMENT AS SET FORTH IN THIS WARRANTY STATEMENT. ALL EXPRESS AND IMPLIED WARRANTIES FOR THE PRODUCT, INCLUDING BUT NOT LIMITED TO ANY IMPLIED WARRANTIES AND CONDITIONS OF MERCHANTABILITY AND FITNESS FOR A PARTICULAR PURPOSE, ARE LIMITED IN TIME TO THE TERM OF THE LIMITED WARRANTY PERIOD REFLECTED ON YOUR PACKING SLIP OR INVOICE. NO WARRANTIES, WHETHER EXPRESS OR IMPLIED, WILL APPLY AFTER THE LIMITED WARRANTY PERIOD HAS EXPIRED. SOME STATES DO NOT ALLOW LIMITATIONS ON HOW LONG AN IMPLIED WARRANTY LASTS, SO THIS LIMITATION MAY NOT APPLY TO YOU.

WE DO NOT ACCEPT LIABILITY BEYOND THE REMEDIES PROVIDED FOR IN THIS LIMITED WARRANTY OR FOR CONSEQUENTIAL OR INCIDENTAL DAMAGES, INCLUDING, WITHOUT LIMITATION, ANY LIABILITY FOR THIRD-PARTY CLAIMS AGAINST YOU FOR DAMAGES, FOR PRODUCTS NOT BEING AVAILABLE FOR USE, OR FOR LOST DATA OR LOST SOFTWARE. OUR LIABILITY WILL BE NO MORE THAN THE AMOUNT YOU PAID FOR THE PRODUCT THAT IS THE SUBJECT OF A CLAIM. THIS IS THE MAXIMUM AMOUNT FOR WHICH WE ARE RESPONSIBLE.

SOME STATES DO NOT ALLOW THE EXCLUSION OR LIMITATION OF INCIDENTAL OR CONSEQUENTIAL DAMAGES, SO THE ABOVE LIMITATION OR EXCLUSION MAY NOT APPLY TO YOU.

### **How long does this limited warranty last?**

This limited warranty lasts for the time period indicated on your packing slip or invoice, except for the following Dell-branded hardware:

- Portable computer batteries carry a 1-year limited warranty.
- Projector lamps carry a 90-day limited warranty.
- Memory carries a lifetime limited warranty.
- Monitors carry the longer of either a 3-year limited warranty or the remainder of the warranty for the Dell computer to which the monitor will be connected.
- Other add-on hardware carries the longer of either a 1-year limited warranty for new parts and a 90-day limited warranty for reconditioned parts or, for both new and reconditioned parts, the remainder of the warranty for the Dell computer on which such parts are installed.

The limited warranty on all Dell-branded products begins on the date of the packing slip or invoice. The warranty period is not extended if we repair or replace a warranted product or any parts. Dell may change the availability of limited warranties, at its discretion, but any changes will not be retroactive.

## What do I do if I need warranty service?

Before the warranty expires, please call us at the relevant number listed in the following table. Please also have your Dell Service Tag or order number available.

<b>Individual Home Consumers:</b>	<b>U.S. Only</b>
Technical Support	1-800-624-9896
Customer Service	1-800-624-9897
<b>Individual Home Consumers who purchased through an Employee Purchase Program:</b>	
Technical Support and Customer Service	1-800-822-8965
<b>Home and Small Business Commercial Customers:</b>	
Technical Support and Customer Service	1-800-456-3355
<b>Medium, Large, or Global Commercial Customers, Healthcare Customers, and Value-Added Resellers (VARs):</b>	
Technical Support and Customer Service	1-800-822-8965
<b>Government and Education Customers:</b>	
Technical Support and Customer Service	1-800-234-1490
<b>Dell-Branded Memory</b>	1-888-363-5150

## What will Dell do?

During the 90 days of the 90-day limited warranty and the first year of all other limited warranties: During the 90 days of the 90-day limited warranty and the first year of all other limited warranties, we will repair any Dell-branded hardware products returned to us that prove to be defective in materials or workmanship. If we are not able to repair the product, we will replace it with a comparable product that is new or refurbished.

When you contact us, we will issue a Return Material Authorization Number for you to include with your return. You must return the products to us in their original or equivalent packaging, prepay shipping charges, and insure the shipment or accept the risk if the product is lost or damaged in shipment. We will return the repaired or replacement products to you. We will pay to ship the repaired or replaced products to you if you use an address in the United States (excluding Puerto Rico and U.S. possessions and territories). Otherwise, we will ship the product to you freight collect.

If we determine that the product is not covered under this warranty, we will notify you and inform you of service alternatives that are available to you on a fee basis.

**NOTE:** Before you ship the product(s) to us, make sure to back up the data on the hard drive(s) and any other storage device(s) in the product(s). Remove any confidential, proprietary, or personal information and removable media such as floppy disks, CDs, or PC Cards. We are not responsible for any of your confidential, proprietary, or personal information; lost or corrupted data; or damaged or lost removable media.

**During the remaining years:** For the remaining period of the limited warranty, we will replace any defective part with new or refurbished parts, if we agree that it needs to be replaced. When you contact us, we will require a valid credit card number at the time you request a replacement part, but we will not charge you for the replacement part as long as you return the original part to us within 30 days after we ship the replacement part to you. If we do not receive the original part within 30 days, we will charge to your credit card the then-current standard price for that part.

We will pay to ship the part to you if you use an address in the United States (excluding Puerto Rico and U.S. possessions and territories). Otherwise, we will ship the part freight collect. We will also include a prepaid shipping container with each replacement part for your use in returning the replaced part to us.

**NOTE:** Before you replace parts, make sure to back up the data on the hard drive(s) and any other storage device(s) in the product(s). We are not responsible for lost or corrupted data.

### **What if I purchased a service contract?**

If your service contract is with Dell, service will be provided to you under the terms of the service agreement. Please refer to that contract for details on how to obtain service.

If you purchased through us a service contract with one of our third-party service providers, please refer to that contract for details on how to obtain service.

### **How will you fix my product?**

We use new and refurbished parts made by various manufacturers in performing warranty repairs and in building replacement parts and systems. Refurbished parts and systems are parts or systems that have been returned to Dell, some of which were never used by a customer. All parts and systems are inspected and tested for quality. Replacement parts and systems are covered for the remaining period of the limited warranty for the product you bought. Dell owns all parts removed from repaired products.

### **May I transfer the limited warranty?**

Limited warranties on systems may be transferred if the current owner transfers ownership of the system and records the transfer with us. The limited warranty on Dell-branded memory may not be transferred. You may record your transfer by going to Dell's website:

- If you are an Individual Home Consumer, go to [www.dell.com/us/en/dhs/topics/sbtopic\\_015\\_ccare.htm](http://www.dell.com/us/en/dhs/topics/sbtopic_015_ccare.htm)
- If you are a Home Office, Small, Medium, Large, or Global Commercial Customer, go to [www.dell.com/us/en/biz/topics/sbtopic\\_ccare\\_nav\\_015\\_ccare.htm](http://www.dell.com/us/en/biz/topics/sbtopic_ccare_nav_015_ccare.htm)
- If you are a Government, Education, or Healthcare Customer, or an Individual Home Consumer who purchased through an Employee Purchase Program, go to [www.dell.com/us/en/pub/topics/sbtopic\\_015\\_ccare.htm](http://www.dell.com/us/en/pub/topics/sbtopic_015_ccare.htm)

If you do not have Internet access, call your customer care representative or call 1-800-624-9897.

## **"Total Satisfaction" Return Policy (U.S. Only)**

We value our relationship with you and want to make sure that you're satisfied with your purchases. That's why we offer a "Total Satisfaction" return policy for most products that you—the end-user customer—purchase directly from Dell. Under this policy, you may return to Dell products that you purchased directly from Dell for a credit or a refund of the purchase price paid, less shipping and handling and applicable restocking fees as follows:

- **New Hardware Products and Accessories** — All new hardware, accessories, parts, and unopened software still in its sealed package, excluding the products listed below, may be returned within 30 days from the date on the packing slip or invoice. To return applications software or an operating system that has been installed by Dell, you must return the entire computer. A different return policy applies to nondefective products purchased through Dell's Software and Peripherals division by customers of our Small and Medium Business divisions. Those products may be returned within 30 days from the date on the packing slip or invoice, but a fifteen percent (15%) restocking fee will be deducted from any refund or credit. The "Total Satisfaction" Return Policy and Software and Peripherals division return policy are not available for Dell | EMC storage products, EMC-branded products, or enterprise software.
- **Reconditioned or Refurbished Dell-Branded Hardware Products and Parts** — All reconditioned or refurbished Dell-branded server and storage products may be returned within 30 days from the date on the packing slip or invoice. All other reconditioned or refurbished Dell-branded hardware products and parts may be returned within 14 days of the date on the packing slip or invoice.

To return products, e-mail or call Dell customer service to receive a Credit Return Authorization Number within the return policy period applicable to the product you want to return. You must obtain a Credit Return Authorization Number in order to return the product. See "Contacting Dell" or "Getting Help" in your customer documentation (or [www.dell.com/us/en/gen/contact.htm](http://www.dell.com/us/en/gen/contact.htm)) to find the appropriate contact information for obtaining customer assistance.

You must ship the products to Dell within 5 days of the date that Dell issues the Credit Return Authorization Number. You must also return the products to Dell in their original packaging, in as-new condition along with any media, documentation, and all other items that were included in the original shipment, prepay shipping charges, and insure the shipment or accept the risk of loss or damage during shipment.

## **Limited Warranty Terms for Dell-Branded Hardware Products (Canada Only)**

### **What is covered by this limited warranty?**

This limited warranty covers defects in materials and workmanship in your—our end-user customer's—Dell-branded hardware products, including Dell-branded peripheral products.

## What is not covered by this limited warranty?

This limited warranty does not cover:

- Software, including the operating system and software added to the Dell-branded hardware products through our factory-integration system, or the reloading of the software
- Non-Dell branded and Solution Provider Direct products and accessories
- Problems that result from:
  - External causes such as accident, abuse, misuse, or problems with electrical power
  - Servicing not authorized by Dell
  - Usage that is not in accordance with product instructions
  - Failure to follow the product instructions or failure to perform preventive maintenance
  - Problems caused by using accessories, parts, or components not supplied by Dell
- Products with missing or altered Service Tags or serial numbers
- Products for which Dell has not received payment

THIS WARRANTY GIVES YOU SPECIFIC LEGAL RIGHTS, AND YOU MAY ALSO HAVE OTHER RIGHTS WHICH VARY FROM PROVINCE TO PROVINCE. DELL'S RESPONSIBILITY FOR MALFUNCTIONS AND DEFECTS IN PRODUCT IS LIMITED TO REPAIR AND REPLACEMENT AS SET FORTH IN THIS WARRANTY STATEMENT, FOR THE TERM OF THE WARRANTY PERIOD REFLECTED ON YOUR PACKING SLIP OR INVOICE. EXCEPT FOR THE EXPRESS WARRANTIES CONTAINED IN THIS WARRANTY STATEMENT, DELL DISCLAIMS ALL OTHER WARRANTIES AND CONDITIONS, EXPRESS OR IMPLIED, INCLUDING WITHOUT LIMITATION IMPLIED WARRANTIES AND CONDITIONS OF MERCHANTABILITY AND FITNESS FOR A PARTICULAR PURPOSE, STATUTORY OR OTHERWISE. SOME PROVINCES DO NOT ALLOW THE EXCLUSION OF CERTAIN IMPLIED WARRANTIES OR CONDITIONS, OR LIMITATIONS ON HOW LONG AN IMPLIED WARRANTY OR CONDITION LASTS. THEREFORE, THE FOREGOING EXCLUSIONS AND LIMITATIONS MAY NOT APPLY TO YOU.

WE DO NOT ACCEPT LIABILITY BEYOND THE REMEDIES PROVIDED FOR IN THIS WARRANTY STATEMENT OR FOR SPECIAL, INDIRECT, CONSEQUENTIAL, OR INCIDENTAL DAMAGES, INCLUDING, WITHOUT LIMITATION, ANY LIABILITY FOR THIRD-PARTY CLAIMS AGAINST YOU FOR DAMAGES, FOR PRODUCTS NOT BEING AVAILABLE FOR USE, OR FOR LOST DATA OR LOST SOFTWARE. OUR LIABILITY WILL BE NO MORE THAN THE AMOUNT YOU PAID FOR THE PRODUCT THAT IS THE SUBJECT OF A CLAIM. THIS IS THE MAXIMUM AMOUNT FOR WHICH WE ARE RESPONSIBLE.

SOME PROVINCES DO NOT ALLOW THE EXCLUSION OR LIMITATION OF SPECIAL, INDIRECT, INCIDENTAL, OR CONSEQUENTIAL DAMAGES, SO THE ABOVE LIMITATION OR EXCLUSION MAY NOT APPLY TO YOU.

## How long does this limited warranty last?

This limited warranty lasts for the time period indicated on your packing slip or invoice, except that the limited warranty on Dell-branded batteries lasts only 1 year and the limited warranty on the lamps for Dell-branded projectors lasts only 90 days. The limited warranty begins on the date of the packing slip or invoice. The warranty period is not extended if we repair or replace a warranted product or any parts. Dell may change the terms and availability of limited warranties, at its discretion, but any changes will not be retroactive (that is, the warranty terms in place at the time of purchase will apply to your purchase).

## What do I do if I need warranty service?

Before the warranty expires, please call us at the relevant number listed in the following table. Please also have your Dell Service Tag or order number available.

<b>Individual Home Consumers; Home Office and Small Business Customers:</b>	<b>Canada Only</b>
Technical Support and Customer Service	1-800-847-4096
<b>Medium, Large, and Global Commercial Customers; Government, Education, and Healthcare Customers; and Value-Added Resellers (VARs):</b>	
Technical Support	1-800-387-5757
Customer Service	1-800-326-9463
<b>Government or Education Customers, or Individual Home Consumers who purchased through an Employee Purchase Program:</b>	
Technical Support	1-800-387-5757
Customer Service	1-800-326-9463 (Extension 8221 for Individual Consumers)
<b>Dell-Branded Memory</b>	1-888-363-5150

## What will Dell do?

**During the 90 days of the 90-day limited warranty and the first year of all other limited warranties:** During the 90 days of the 90-day limited warranty and the first year of all other limited warranties, we will repair any Dell-branded hardware products returned to us that prove to be defective in materials or workmanship. If we are not able to repair the product, we will replace it with a comparable product that is new or refurbished.

When you contact us, we will issue a Return Material Authorization Number for you to include with your return. You must return the products to us in their original or equivalent packaging, prepay shipping charges, and insure the shipment or accept the risk if the product is lost or damaged in shipment. We will return the repaired or replacement products to you. We will pay to ship the repaired or replaced products to you if you use an address in Canada. Otherwise, we will ship the product to you freight collect.

If we determine that the problem is not covered under this warranty, we will notify you and inform you of service alternatives that are available to you on a fee basis.

**NOTE:** Before you ship the product(s) to us, make sure to back up the data on the hard drive(s) and any other storage device(s) in the product(s). Remove any confidential, proprietary or personal information, removable media, such as floppy disks, CDs, or PC Cards. We are not responsible for any of your confidential, proprietary or personal information; lost or corrupted data; or damaged or lost removable media.

**During the remaining years following the first year of all limited warranties:** We will replace any defective part with new or refurbished parts, if we agree that it needs to be replaced. When you contact us, we will require a valid credit card number at the time you request a replacement part, but we will not charge you for the replacement part as long as you return the original part to us within 30 days after we ship the replacement part to you. If we do not receive the original part within 30 days, we will charge to your credit card the then-current standard price for that part.

We will pay to ship the part to you if you use an address in Canada. Otherwise, we will ship the part freight collect. We will also include a prepaid shipping container with each replacement part for your use in returning the replaced part to us.

**NOTE:** Before you replace parts, make sure to back up the data on the hard drive(s) and any other storage device(s) in the product(s). We are not responsible for lost or corrupted data.

### **What if I purchased a service contract?**

If your service contract is with Dell, service will be provided to you under the terms of the service contract. Please refer to that contract for details on how to obtain service. Dell's service contracts can be found online at [www.dell.ca](http://www.dell.ca) or by calling Customer Care at 1-800-847-4096. If you purchased through us a service contract with one of our third-party service providers, please refer to that contract (mailed to you with your packing slip or invoice) for details on how to obtain service.

### **How will you fix my product?**

We use new and refurbished parts made by various manufacturers in performing warranty repairs and in building replacement parts and systems. Refurbished parts and systems are parts or systems that have been returned to Dell, some of which were never used by a customer. All parts and systems are inspected and tested for quality. Replacement parts and systems are covered for the remaining period of the limited warranty for the product you bought. Dell owns all parts removed from repaired products.

### **May I transfer the limited warranty?**

Limited warranties on systems may be transferred if the current owner transfers ownership of the system and records the transfer with us. The limited warranty on Dell-branded memory may not be transferred. You may record your transfer by going to Dell's website:

- For Canada-purchased computers (in-country transfers) and to transfer from one customer to another, go to [www.dell.ca/ca/en/gen/topics/segtopic\\_ccare\\_nav\\_013\\_ccare.htm](http://www.dell.ca/ca/en/gen/topics/segtopic_ccare_nav_013_ccare.htm)
- For out-of-country transfers (outside of the original country of purchase), go to [www.dell.com/us/en/biz/topics/sbtopic\\_ccare\\_nav\\_016\\_ccare.htm](http://www.dell.com/us/en/biz/topics/sbtopic_ccare_nav_016_ccare.htm)

If you do not have Internet access, call Dell at 1-800-847-4096 (Home Consumer customers) or 1-800-326-9463 (Corporate Commercial or Government customers).

## **"Total Satisfaction" Return Policy (Canada Only)**

If you are an end-user customer who bought new products directly from Dell, you may return them to Dell up to 30 days after you receive them for a refund or credit of the product purchase price. If you are an end-user customer who bought reconditioned or refurbished products from Dell, you may return them to Dell within 14 days after the date on the packing slip or invoice for a refund or credit of the product purchase price. In either case, the refund or credit will not include any shipping and handling charges shown on your packing slip or invoice and will be subject to a fifteen percent (15%) restocking fee, unless otherwise prohibited by law. If you are an organization that bought the products under a written agreement with Dell, the agreement may contain different terms for the return of products than specified by this policy.

To return products, you must call Dell Customer Service at 1-800-847-4096 to receive a Credit Return Authorization Number. To expedite the process of your refund or credit, Dell expects you to return the products to Dell in their original packaging within 5 days of the date that Dell issues the Credit Return Authorization Number. You must also prepay shipping charges and insure the shipment or accept the risk of loss or damage during shipment. You may return software for a refund or credit only if the sealed package containing the floppy disk(s) or CD(s) is unopened. Returned products must be in as-new condition, and all of the manuals, floppy disk(s), CD(s), power cables, and other items included with a product must be returned with it. For customers who want to return, for refund or credit only, either application or operating system software that has been installed by Dell, the whole system must be returned, along with any media and documentation that may have been included in the original shipment.

The "Total Satisfaction" Return Policy does not apply to Dell | EMC storage products. It also does not apply to products purchased through Dell's Software and Peripherals division. For those products, please instead refer to Dell's Software and Peripheral's then-current return policy (see the following section, "Dell Software and Peripherals (Canada Only)").

## **Dell Software and Peripherals (Canada Only)**

### **Third-Party Software and Peripherals Products**

Similar to other resellers of software and peripherals, Dell does not warrant third-party products. Third-party software and peripheral products are covered by the warranties provided by the original manufacturer or publisher only. Third-party manufacturer warranties vary from product to product. Consult your product documentation for specific warranty information. More information may also be available from the manufacturer or publisher.

While Dell offers a wide selection of software and peripheral products, we do not specifically test or guarantee that all of the products we offer work with any or all of the various models of Dell computers, nor do we test or guarantee all of the products we sell on the hundreds of different brands of computers available today. If you have questions about compatibility, we recommend and encourage you to contact the third-party software and peripheral product manufacturer or publisher directly.

## **Dell-Branded Peripheral Products**

Dell does provide a limited warranty for new Dell-branded peripheral products (products for which Dell is listed as the manufacturer) such as monitors, batteries, memory, docking stations, and projectors. To determine which limited warranty applies to the product you purchased, see the Dell packing slip or invoice and/or the product documentation that accompanied your product. Descriptions of Dell's limited warranties are described in preceding sections.

## **Return Policy**

If you are an end-user customer who bought Dell Software and Peripherals products directly from a Dell company, you may return Dell Software and Peripherals products that are in as-new condition to Dell up to 30 days from the date on the packing slip or invoice for a refund of the product purchase price if already paid. This refund will not include any shipping and handling charges shown on your packing slip or invoice; you are responsible for those.

To return products, you must call Dell Customer Service at 1-800-387-5759 to receive a Credit Return Authorization Number. You must ship the Dell Software and Peripherals products back to Dell in their original manufacturer's packaging (which must be in as-new condition), prepay shipping charges, and insure the shipment or accept the risk of loss or damage during shipment.

To qualify for refund or replacement, returned products must be in as-new condition, software products must be unopened, and all of the manuals, floppy disk(s), CD(s), power cables, and other items included with a product must be returned with it.

## **1-Year End-User Manufacturer Guarantee (Latin America and the Caribbean Only)**

### **Guarantee**

Dell Computer Corporation ("Dell") warrants to the end user in accordance with the following provisions that its branded hardware products, purchased by the end user from a Dell company or an authorized Dell distributor in Latin America or the Caribbean, will be free from defects in materials, workmanship, and design affecting normal use, for a period of 1 year from the original purchase date. Products for which proper claims are made will, at Dell's option, be repaired or replaced at Dell's expense. Dell owns all parts removed from repaired products. Dell uses new and reconditioned parts made by various manufacturers in performing repairs and building replacement products.

### **Exclusions**

This Guarantee does not apply to defects resulting from: improper or inadequate installation, use, or maintenance; actions or modifications by unauthorized third parties or the end user; accidental or willful damage; or normal wear and tear.

## **Making a Claim**

Claims must be made in Latin America or the Caribbean by contacting the Dell point of sale within the guarantee period. The end user must always supply proof of purchase, indicating name and address of the seller, date of purchase, model and serial number, name and address of the customer, and details of symptoms and configuration at the time of malfunction, including peripherals and software used. Otherwise, Dell may refuse the guarantee claim. Upon diagnosis of a warranted defect, Dell will make arrangements and pay for ground freight and insurance to and from Dell's repair/replacement center. The end user must ensure that the defective product is available for collection properly packed in original or equally protective packaging together with the details listed above and the return number provided to the end user by Dell.

## **Limitation and Statutory Rights**

Dell makes no other warranty, guarantee or like statement other than as explicitly stated above, and this Guarantee is given in place of all other guarantees whatsoever, to the fullest extent permitted by law. In the absence of applicable legislation, this Guarantee will be the end user's sole and exclusive remedy against Dell or any of its affiliates, and neither Dell nor any of its affiliates shall be liable for loss of profit or contracts, or any other indirect or consequential loss arising from negligence, breach of contract, or howsoever.

**This Guarantee does not impair or affect mandatory statutory rights of the end user against and/or any rights resulting from other contracts concluded by the end user with Dell and/or any other seller.**

### **Dell World Trade LP**

One Dell Way, Round Rock, TX 78682, USA

### **Dell Computadores do Brasil Ltda (CNPJ No. 72.381.189/0001-10)**

Avenida Industrial Belgraf, 400  
92990-000 - Eldorado do Sul – RS - Brasil

### **Dell Computer de Chile Ltda**

Coyancura 2283, Piso 3- Of.302,  
Providencia, Santiago - Chile

### **Dell Computer de Colombia Corporation**

Carrera 7 #115-33 Oficina 603  
Bogota, Colombia

### **Dell Computer de Mexico SA de CV**

Paseo de la Reforma 2620 - 11° Piso  
Col. Lomas Altas  
11950 México, D.F.

# Intel® Warranty Statement for Pentium® and Celeron® Processors Only (U.S. and Canada Only)

## Intel's Three Year Limited Warranty

### Limited Warranty

Intel warrants that its family of Pentium® and Celeron® processors, if properly used and installed, will be free from defects in materials and workmanship and will substantially conform to Intel's publicly available specifications for a period of three (3) years after the date the Pentium or Celeron processor was purchased (whether purchased separately or as part of a computer system).

If the Pentium or Celeron processor, which is the subject of this Limited Warranty, fails during the warranty period for reasons covered by this Limited Warranty, Intel, at its option, will:

- REPAIR the Pentium or Celeron processor by means of hardware and/or software; OR
- REPLACE the Pentium or Celeron processor with another Pentium or Celeron processor; OR
- If Intel is unable to repair or replace the particular Pentium or Celeron processor,
- REFUND the then-current value of the Pentium or Celeron processor.

THIS LIMITED WARRANTY, AND ANY IMPLIED WARRANTIES THAT MAY EXIST UNDER STATE LAW, APPLY ONLY TO THE ORIGINAL PURCHASER OF THE PENTIUM OR CELERON PROCESSOR, OR PENTIUM OR CELERON PROCESSOR-BASED COMPUTER AND LAST ONLY FOR AS LONG AS SUCH PURCHASER CONTINUES TO OWN THE PROCESSOR.

### Extent of Limited Warranty

Intel does not warrant that your Pentium or Celeron processor will be free from design defects or errors known as "errata." Current characterized errata are available upon request. This limited warranty is for purchasers in the United States and Canada only. The limited warranty does not cover any costs relating to removal or replacement of any Pentium or Celeron processors that are soldered or otherwise permanently affixed to your system's motherboard.

This limited warranty does not cover damages due to external causes, including accident, problems with electrical power, usage not in accordance with product instructions, misuse, neglect, alteration, repair, improper installation, or improper testing.

### How to Obtain Warranty Service

To obtain warranty service for your Pentium or Celeron processor, you may contact your computer system manufacturer in accordance with its instructions, or you may contact Intel.

To request warranty service from Intel, you should call Intel at 1-800-628-8686 during the warranty period during normal business hours (Pacific Time), excluding holidays. Please be prepared to provide:

- (1) your name, address, and telephone numbers;
- (2) proof of purchase;
- (3) this Intel warranty card;
- (4) a description of the computer system including the brand and model; and
- (5) an explanation of the problem.

[Note: The Customer Service Representative may need additional information from you depending on the nature of the problem.]

The replacement processor is warranted under this written warranty and is subject to the same limitations and exclusions for the remainder of the original warranty period or one (1) year, whichever is longer.

### WARRANTY LIMITATIONS AND EXCLUSIONS

THESE WARRANTIES REPLACE ALL OTHER WARRANTIES, EXPRESS OR IMPLIED INCLUDING, BUT NOT LIMITED TO, THE IMPLIED WARRANTIES OF MERCHANTABILITY AND FITNESS FOR A PARTICULAR PURPOSE. INTEL MAKES NO EXPRESS WARRANTIES BEYOND THOSE STATED HERE. INTEL DISCLAIMS ALL OTHER WARRANTIES, EXPRESS OR IMPLIED, INCLUDING, WITHOUT LIMITATION, IMPLIED WARRANTIES OF MERCHANTABILITY AND FITNESS FOR A PARTICULAR PURPOSE.

SOME LAWS DO NOT ALLOW THE EXCLUSION OF IMPLIED WARRANTIES SO THIS LIMITATION MAY NOT APPLY TO YOU. IF THESE LAWS APPLY, THEN ALL EXPRESS AND IMPLIED WARRANTIES ARE LIMITED IN DURATION TO THE LIMITED WARRANTY PERIOD. NO WARRANTIES APPLY AFTER THAT PERIOD. SOME LAWS DO NOT ALLOW LIMITATIONS ON HOW LONG AN IMPLIED WARRANTY LASTS, SO THIS LIMITATION MAY NOT APPLY TO YOU.

### LIMITATIONS OF LIABILITY

INTEL'S RESPONSIBILITY UNDER THIS, OR ANY OTHER WARRANTY, IMPLIED OR EXPRESS, IS LIMITED TO REPAIR, REPLACEMENT OR REFUND, AS SET FORTH ABOVE. THESE REMEDIES ARE THE SOLE AND EXCLUSIVE REMEDIES FOR ANY BREACH OF WARRANTY. INTEL IS NOT RESPONSIBLE FOR INDIRECT, SPECIAL, INCIDENTAL, OR CONSEQUENTIAL DAMAGES RESULTING FROM ANY BREACH OF WARRANTY OR UNDER ANY OTHER LEGAL THEORY INCLUDING, BUT NOT LIMITED TO, LOST PROFITS, DOWNTIME, GOODWILL, DAMAGE TO OR REPLACEMENT OF EQUIPMENT AND PROPERTY, AND ANY COSTS OF RECOVERING, REPROGRAMMING, OR REPRODUCING ANY PROGRAM OR DATA STORED IN OR USED WITH A SYSTEM CONTAINING YOUR PENTIUM PROCESSOR. SOME JURISDICTIONS DO NOT ALLOW THE EXCLUSION OR LIMITATION OF INCIDENTAL OR CONSEQUENTIAL DAMAGES, SO THE ABOVE LIMITATIONS OR EXCLUSIONS MAY NOT APPLY TO YOU.

THE LIMITED WARRANTY GIVES YOU SPECIFIC LEGAL RIGHTS, AND YOU MAY ALSO HAVE OTHER RIGHTS THAT VARY FROM JURISDICTION TO JURISDICTION.

**Intel Pentium® and Celeron® Processors are backed by a three-year limited warranty.  
Please refer to the reverse side of this card for complete warranty details.**

**Intel's Commitment to Quality**

Intel is committed to producing the highest quality processors available. That's why we have hundreds of people dedicated to continuously improve our design, manufacturing, and testing technology.

We put every one of our Pentium® and Celeron® processors through a rigorous battery of tests during the design and manufacturing processes.

To verify that the new chip will correctly run the software written for Intel Architecture processors, a team of Intel engineers is dedicated to compatibility testing. In a state-of-art lab, this group runs an extensive set of operating systems, applications, network tests and stress tests repeatedly to ensure that the processor is compatible with representative software.

Just as importantly, we work with hardware and software companies in the computer industry to ensure that our processors are compatible with their products.

Additionally, a sampling of Intel processors are subjected to a rigorous "burn-in" test whereby the chip is operated at higher-than-normal temperatures and voltages. During this burn-in period, the processor experiences the equivalent of weeks of normal usage. These units are monitored for failures as part of our ongoing quality assurance process.

As a result, today's microprocessors from Intel are among the most reliable components in computers.

**What are "Errata"?**

Exhaustive product testing can highlight differences between the actual behavior of the microprocessor and its specifications. Sometimes the discrepancies are caused by a design defect or error, which we call errata. Rigorous validation identifies most errata during the development of the processor, but we do detect additional errata during the life cycle of a microprocessor.

When an erratum is identified, our engineers work to characterize it and find a solution. We work with system designers and software developers to ensure that the discrepancy does not affect their products. If necessary, special software or hardware solutions (sometimes known as "work arounds") are implemented in the system design to prevent computer users from encountering the problem. Errata may then be corrected in future revisions of the microprocessor.

No microprocessor is perfect, and Intel recognizes that some consumers want to know about any errata, whether or not the errata affect them. Intel makes documentation of all characterized Pentium and Celeron processor errata publicly available through our Technical Documentation Service.

*At Intel, our goal is to make every computer user satisfied with his or her Pentium or Celeron processor. Should you have any questions, comments or concerns about your Intel microprocessor, please call us at 1-800-628-8686.*

©1997, 1998 Intel Corporation. All rights reserved.



# Index

## A

- air vents
  - description, 23, 29
  - system view, 23, 29
- audio connectors
  - description, 24
  - system view, 24

## B

- battery
  - charge gauge, 48
  - charging, 49
  - checking the charge, 47
  - description, 31
  - installing, 50
  - low-battery warning, 48
  - performance, 46
  - power meter, 48
  - removing, 49
  - storing, 52
  - system view, 31

## C

- CD-RW drive
  - fixing problems, 74
- characters
  - unexpected, 69

- computer
  - crashes, 104
  - specifications, 128
- conflicts
  - drivers, 107
  - resolving software and hardware incompatibilities, 112
- copying CDs
  - general information, 74
  - helpful tips, 75
  - instructions, 76
- crashes, 104

## D

- damaged computer
  - testing, 106
- Dell support policy, 138
- Device Driver Rollback, 108
- device latch release
  - description, 26, 30
  - system view, 26, 30
- device status lights, 21
  - description, 21
- display
  - description, 20
  - system view, 20
- display latch

- description, 22
- system view, 22

- docking device latch
  - description, 31
  - system view, 31

- drivers
  - definition, 107
  - reinstalling, 108, 113
  - troubleshooting, 107

- drives
  - fixing problems, 102

## E

- e-mail
  - fixing problems, 36

## F

- fan
  - description, 31
  - system view, 31
- Files and Settings Transfer Wizard, 37
- finding solutions, 96
- floppy drive
  - connecting to the parallel port, 27
  - fixing problems, 102

- H**
- hard drive
    - description, 24, 31
    - preventing damage, 125
    - replacing, 123
    - system view, 24, 31
  - hardware
    - drivers, 107
  - Hardware Troubleshooter, 112
  - help file
    - accessing, 98
- I**
- infrared sensor
    - description, 24
    - system view, 24
  - Internet connection
    - about, 34
    - options, 34
    - setting up, 34
  - IR sensor
    - See* infrared sensor
  - IRQ conflicts, 112
- K**
- keyboard
    - description, 22
    - fixing problems, 69
    - shortcuts, 65
    - system view, 22
    - unexpected characters, 69
  - keyboard status lights
    - description, 22
    - system view, 22
  - keypad
    - numeric, 64
- L**
- line conditioners, 42
- M**
- memory
    - adding, 118
    - removing, 119
  - memory module cover
    - description, 30
    - system view, 30
  - Mini PCI card
    - description, 30
    - installing, 120
    - system view, 30
  - modem
    - description, 30
    - system view, 30
  - modem connector
    - description, 28
    - system view, 28
  - module bay
    - about, 53
    - description, 26
    - swapping devices while the computer is running, 58
    - swapping devices while the computer is turned off, 54
    - system view, 26
- N**
- network
    - fixing problems, 85
  - network connector
    - description, 28
    - system view, 28
- P**
- parallel connector
    - description, 28
    - system view, 28
  - PC Card slot
    - description, 23
    - system view, 23
  - PC Cards
    - fixing problems, 103
  - power
    - fixing problems, 52
    - turning off your computer, 43
  - power button
    - description, 20
    - system view, 20
  - printer
    - cable, 39
    - connecting, 38
    - parallel, 39
    - setting up, 38
    - USB, 40
  - programs
    - crashes, 104
    - fixing problems, 104
    - not responding, 104

## R

RAM. *See* memory

reinstalling  
drivers, 108, 113

## S

safety instructions, 11

security cable slot  
description, 24-25  
system view, 24-25

serial connector  
description, 29  
system view, 29

shutting down your  
computer, 43

smart card slot  
description, 24  
system view, 24

software  
fixing problems, 104  
reinstalling software, 108, 113

speakers  
description, 22  
system view, 22

specifications, system, 128

surge protectors, 42

S-video TV-out connector  
description, 28  
system view, 28

System Restore, 110

system setup program  
commonly used options, 136  
screens, 135

viewing, 135  
system specifications, 128  
system view, 21

## T

Tell Me How help file  
accessing, 98

touch pad  
customizing, 68  
description, 22  
system view, 22

touch pad buttons  
description, 22  
system view, 22

troubleshooting  
about, 96  
cannot save to floppy disk, 102  
CD-RW drive stops  
writing, 74  
conflicts, 112  
Device Driver Rollback, 108  
drivers, 107  
dropped or damaged  
computer, 106  
e-mail problems, 36  
external keyboard  
problems, 69  
Hardware Troubleshooter, 112  
network problems, 85  
PC Card problems, 103  
power problems, 52  
program crash, 104  
program stopped  
responding, 104  
scanner problems, 101  
System Restore, 110

unexpected characters, 69  
wet computer, 105  
turning off your computer, 43

## U

uninterruptible power  
supplies  
*See* UPS

UPS, 42

USB connector  
description, 27  
system view, 27

## V

video connector  
description, 28  
system view, 28

## W

warranty, 159

wet computer, 105

Windows XP  
Device Driver Rollback, 108  
Hardware Troubleshooter, 112  
help, 98  
System Restore, 110

